



OPTIBELT
TECHNICAL MANUAL
RUBBER TIMING BELT DRIVES



**INCL. PULLEYS
& BUSHES**



TECHNICAL MANUAL

RUBBER TIMING BELT DRIVES



optibelt OMEGA and optibelt ZR timing belts have been developed for the use in high performance drives. Drive speed is transmitted synchronously, i.e. without speed loss, and with a constant transmission ratio.

The optibelt OMEGA tooth profile significantly reduces the running noise level. The teeth are designed to ensure that they mesh perfectly, with minimal friction, into the pulley teeth. optibelt OMEGA timing belts run in HTD® and RPP® pulleys.

This technical manual contains all important information for the belts' usage. Furthermore, the calculation methods for the drive design with OMEGA, OMEGA HP, OMEGA FAN POWER, OMEGA HL and ZR timing belts are also presented.

The belt characteristics described may change due to various influences. Thus, the drives must be designed based on their intended use (or in a way that comes close to their intended use).

If you have any further questions, please make use of the free service offered by our Application Engineering Department.

OPTIBELT WORLDWIDE





www.optibelt.com







	OPTIBELT GMBH www.optibelt.de		OPTIBELT ÖSTERREICH GMBH www.optibelt.at
	OPTIBELT (UK) LTD. www.optibelt.co.uk		OPTIBELT POLSKA SP. Z O.O. www.optibelt.pl
	OPTIBELT NEDERLAND B.V. www.optibelt.nl		ООО „OPTIBELT POWER TRANSMISSION“ www.optibelt.ru
	OPTIBELT FINLAND OY www.optibelt.fi		OPTIBELT HUNGARY KFT. www.optibelt.hu
	OPTIBELT SKANDINAVISKA AB www.optibelt.se		OPTIBELT CORPORATION www.optibelt.us
	SALES DÄNEMARK www.optibelt.dk		OPTIBELT (CANADA) INC. www.optibelt.ca
	SALES NORWEGEN www.optibelt.no		OPTIBELT DO BRASIL LTDA. www.optibelt-br.com
	OPTIBELT FRANCE SAS www.optibelt.fr		OPTIBELT ASIA PACIFIC PTE. LTD. www.optibelt.sg
	OPTIBELT AG www.optibelt.ch		OPTIBELT POWER TRANSMISSION www.optibelt.cn
	OPTIBELT GMBH www.optibelt.be		OPTIBELT POWER TRANSMISSION INDIA PVT. LTD. www.optibelt.in
	OPTIBELT ESPAÑA, S.A. www.optibelt.es		OPTIBELT AUSTRALIA PTY. LTD. www.optibelt.com.au
	OPTIBELT AG www.optibelt.it		OPTIBELT INDONESIAEN www.optibelt.id
	OPTIBELT PHILIPPINEN www.optibelt.ph		OPTIBELT MEXIKO www.optibelt.mx
	OPTIBELT VIETNAM www.optibelt.vn		OPTIBELT THAILAND www.optibelt.th

TABLE OF CONTENTS



Introduction	1
Sales organisation of the Arntz optibelt Group	2

PRODUCT DESCRIPTION

optibelt OMEGA

Timing Belts in optibelt OMEGA Profile	6-7
optibelt OMEGA HL Timing Belts	8-9
optibelt OMEGA HL, Standard Product Range	10-11
optibelt OMEGA FAN POWER Timing Belts	12
optibelt OMEGA FAN POWER, Standard Product Range	13
optibelt OMEGA HP Timing Belts	14-15
optibelt OMEGA HP, Standard Product Range	16-19
optibelt OMEGA Timing Belts	20
optibelt OMEGA, Standard Product Range	21-27

optibelt ZR

optibelt ZR Timing Belts	28-29
Standard Properties/Special Designs	30
optibelt OMEGA LINEAR and optibelt ZR LINEAR	31
optibelt ZR Timing Belts, Standard Product Range, Profiles MXL, XL, L, H, XH, XXH, DXL, DL, DH	32-34

DRIVE DESIGN

optibelt OMEGA

Explanation of Symbols	35
optibelt OMEGA HL Timing Belts, Guidelines for Selection	36
optibelt OMEGA HP and optibelt OMEGA FAN POWER Timing Belts, Guidelines for Selection	37
optibelt OMEGA Timing Belts, Guidelines for Selection	38
optibelt ZR Timing Belts, Guidelines for Selection	39
Load Factors	40
Additional Factors	41
Formulas and Calculation Examples	42-43
Belt Tension	44
Drive Design with optibelt CAP Drive Calculation Programme	45

POWER RATINGS

optibelt OMEGA

optibelt OMEGA HL Timing Belts, Profile and Design 8M HL	46
optibelt OMEGA HL Timing Belts, Profile and Design 14M HL	47
optibelt OMEGA FAN POWER Timing Belts, Profile and Design 8M FP	48
optibelt OMEGA FAN POWER Timing Belts, Profile and Design 14M FP	49
optibelt OMEGA HP Timing Belts, Profile and Design 3M HP	50
optibelt OMEGA HP Timing Belts, Profile and Design 5M HP	51
optibelt OMEGA HP Timing Belts, Profile and Design 8M HP	52
optibelt OMEGA HP Timing Belts, Profile and Design 14M HP	53
optibelt OMEGA Timing Belts, Profile and Design 2M	54
optibelt OMEGA Timing Belts, Profile and Design 3M	55
optibelt OMEGA Timing Belts, Profile and Design 5M	56
optibelt OMEGA Timing Belts, Profile and Design 8M	57
optibelt OMEGA Timing Belts, Profile and Design 14M	58

TABLE OF CONTENTS



POWER RATINGS

optibelt ZR

optibelt ZR Profile MXL	60-61
optibelt ZR Profile XL	62-63
optibelt ZR Profile L	64-65
optibelt ZR Profile H	66-67
optibelt ZR Profile XH	68-69
optibelt ZR Profile XXH	70-71

DIMENSIONS AND TOLERANCES

optibelt OMEGA

Timing Belts in optibelt OMEGA Profile	72
Timing Belt Pulleys, Pitch Diameter and Outside Diameter	73-76
optibelt ZRS HTD® Timing Belt Pulleys for Cylindrical Bores	77-84
optibelt ZRS HTD® Timing Belt Pulleys for Taper Bushes	85-90
optibelt TB Taper Bushes	91
Timing Belt Pulleys, Recommended Special Designs	92
Timing Belt Pulleys, Dimensions and Tolerances	93-94

optibelt ZRS

Dimensions and Tolerances	95-97
Pitch and Outside Diameter	98-99
optibelt ZRS Profile XL, L for Cylindrical Bores	100-101
optibelt ZRS Profile H for Cylindrical Bores	102-104
optibelt ZRS Profile XH for Cylindrical Bores	104-105
optibelt ZRS Profile L for optibelt TB Taper Bushes	106-107
optibelt ZRS Profile H for optibelt TB Taper Bushes	108-109
optibelt ZRS Profile XH for optibelt TB Taper Bushes	110-111

DESIGN HINTS

optibelt OMEGA

Flanged Pulleys/Tension Idlers	112
Installation and Maintenance	113
Problems – Causes – Remedies	114

optibelt ZR

optibelt ZR Timing Belts, Double-sided	115
Overview of Standards	116
Data Sheet for the Calculation/Checking Timing Belt Drives	117-118

PRODUCT DESCRIPTION

TIMING BELTS IN **optibelt OMEGA** PROFILE



optibelt OMEGA Profile

The optibelt OMEGA profile is a further development of the optibelt HTD® profile. Its advantage, compared to the other timing belt profiles, is reduced running noise.



optibelt OMEGA HL

On high and low speed drives the optibelt OMEGA HL timing belt exceeds the performance of the OMEGA HP by up to 15%. It was also specially designed for shock loaded drives.

In new drives for these applications, the OMEGA HL achieves supreme operational reliability combined with optimum economic efficiency. For power ratings see optibelt OMEGA HL pages 46-47.

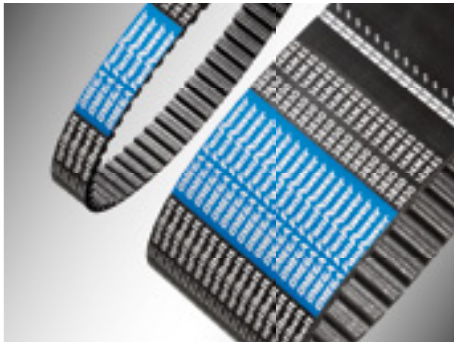

optibelt OMEGA FAN POWER

The optibelt OMEGA FAN POWER timing belt was developed for fan drives in the oil industry.

The optibelt OMEGA FAN POWER is characterised by a long service life and antistatic properties.

For power ratings see optibelt OMEGA FAN POWER pages 48-49.

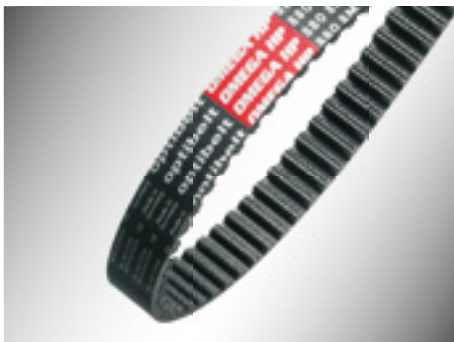

optibelt OMEGA HP

The optibelt OMEGA HP timing belt reaches a performance level up to 150% higher than that of optibelt OMEGA and is especially applicable for cost-efficient new designs.

The optibelt OMEGA HP is suitable for both low speed and high speed drives with high power and steady loads.

For power ratings see optibelt OMEGA HP pages 50-53.



optibelt OMEGA

The optibelt OMEGA timing belt has the performance level of the established optibelt HTD® timing belt and is its replacement. The belt is best for medium performance drives in all speed ranges without heavy shock loading.

Double-sided timing belts for drives with reversible speed can be delivered with HTD® profiles.

Double-sided timing belts with optibelt OMEGA profiles on request.

For power ratings see optibelt OMEGA page 54-58.

OPTIBELT ZRS

optibelt OMEGA, OMEGA HP, OMEGA FAN POWER and OMEGA HL timing belts are used in optibelt ZRS HTD® timing belt pulleys or in RPP® timing belt pulleys.

For applications in other pulleys, please contact the OPTIBELT Application Engineering Department.

PRODUCT DESCRIPTION

TIMING BELTS IN optibelt OMEGA PROFILE

STANDARD PROPERTIES



All optibelt OMEGA timing belts have inherent resistance to oil, heat, cold, ozone and tropical conditions. Special labelling is not required.

Oil resistance

The limited oil resistance prevents the damaging effects of mineral oils and greases, as long as these substances are not in permanent contact with the timing belt and/or are not present in large quantities. With increased demands for resistance, e.g. to mineral oils, the performance of the optibelt OMEGA timing belts can be improved by using special belt constructions. Please contact the optibelt Application Engineering Department.

Temperature resistance

The timing belt can withstand ambient temperatures from $\approx -30\text{ }^{\circ}\text{C}$ to $+100\text{ }^{\circ}\text{C}$. Temperatures outside this range lead to premature ageing and embrittlement of the timing belts and thus to their premature failure. The temperature resistance of optibelt OMEGA timing belts can be extended using special belt constructions, e.g. up to $+140\text{ }^{\circ}\text{C}$. Please contact the OPTIBELT Application Engineering Department.

Antistatic properties

Antistatic properties enable the safe discharge of electrostatic charges. This charging can have such a strong impact on timing belts with insufficient electrical conductivity that there is the danger of ignition due to sparks. The use of antistatic timing belts requires that the properties be checked in accordance with ISO 9563, and is confirmed by the issue of an inspection certificate. OMEGA HP and OMEGA HL timing belts in profiles 8M and 14M as well as OMEGA FAN POWER are antistatic according to ISO 9563 by standard and are thus labelled accordingly.

Noise emission

The optimized tooth shape and the indent in the tooth tip of the optibelt OMEGA promote a significantly lower noise level. In combination with the newly developed materials, the noise level is further reduced, even at high speeds and with high belt tensions.

Operational life

Belt designs with increased capacity can exceed the potential operational life of standard designs many times over, particularly for highly loaded or overloaded drives. Example: Dynamic tests with optibelt OMEGA HP show that the running times, compared to standard timing belts, are up to 18 times higher.

Efficiency

The specially developed tooth fabric and the flexible belt design make possible a virtually frictionless drive with an efficiency of up to 98%.

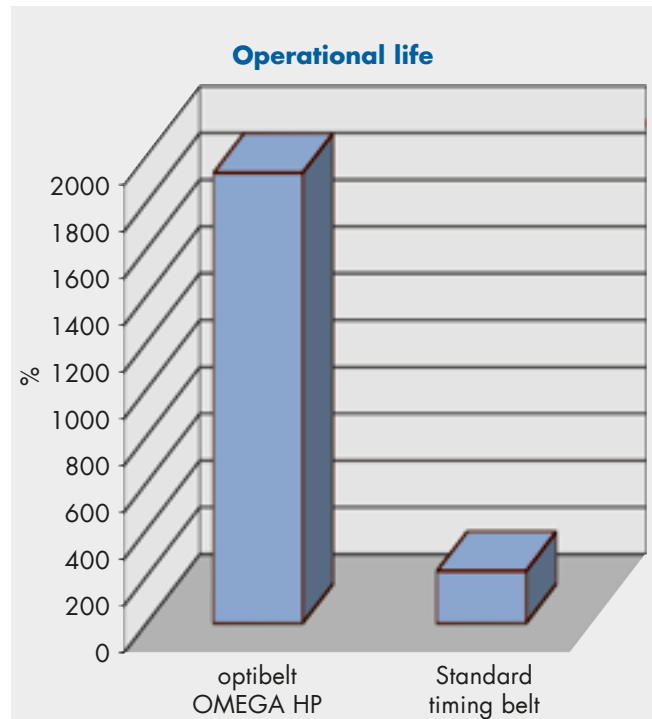

Application example: roller path

PRODUCT DESCRIPTION

OPTIBELT OMEGA HL TIMING BELTS



Structure

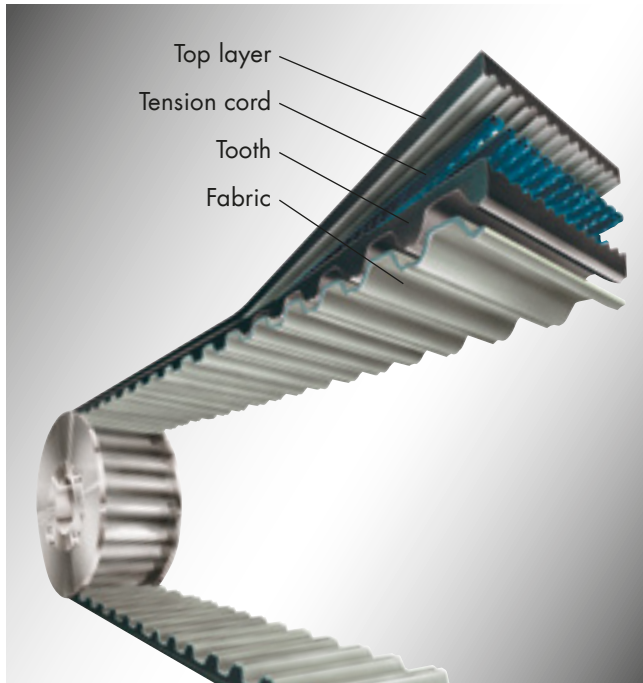

The new high performance timing belt for extremely high loads across the whole speed spectrum

OPTIBELT has developed this belt in the sections 8M and 14M especially for drives with high torques and severe shock loads. These types of drives can often be found in general engineering.

For this use, the structure and the material of the timing belt have been optimised in such a way that highest operational reliability combined with optimal economic efficiency can be achieved when re-designing a drive. Initially, the belt will be available in the 8M section. optibelt OMEGA HL timing belts are used in optibelt ZRS HTD® pulleys or in RPP® timing belt pulleys. For applications in other pulleys, please contact the OPTIBELT Application Engineering Department.

A reinforced glass tension cord is used. This innovative glass cord stands out due to the combination of the following, important characteristics:

- good resistance to shock loads
- very high dynamic resistance
- very low permanent and elastic stretch

Therefore, the belt performance can be increased by an additional 15%, compared to OMEGA HP. In contrast to an aramid cord, which also has a very high resistance to shock loading, the reinforced glass cord has a considerably lower permanent stretch during the running time. Aramid cord has a high permanent stretch (see diagram) during running. The minimal tension loss of the reinforced glass cord enables a keeping of the pitch and thus to a load which is distributed more evenly on the teeth during running.

In addition, the reinforced glass cord can also be used at medium and high speeds while the use of the aramid cord is limited to low and medium speeds. In contrast to the aramid cord, the reinforced glass cord enables a considerable extension to the range of applications.

Top layer

The top layer of the OMEGA HL as well as the teeth, consists of a polychloroprene compound reinforced with aramid fibres. Thus, an even more abrasion resistant surface is in contact with any reverse bend idler. The belt top layer protects the tension cord from environmental influences.

Tension cord

In contrast to the OMEGA HP with glass cord, the OMEGA HL uses a significantly higher strength glass cord. Thus, the power can be further increased by up to 25%. The resistance to shock loads is also significantly increased.

Teeth

The considerably increased tooth strength (compared to OMEGA) is made possible by the use of aramid fibres in the polychloroprene compound. This imparts very high tooth stiffness as well as increased shear strength.

Fabric

The shear strength of the teeth is enhanced by an extremely tough fabric. The shape of the OMEGA teeth and the minimal friction fabric enable a smooth meshing of the belt tooth into the pulley groove. In addition, the special polyamide fabric is very wear resistant.

Belt tension loss

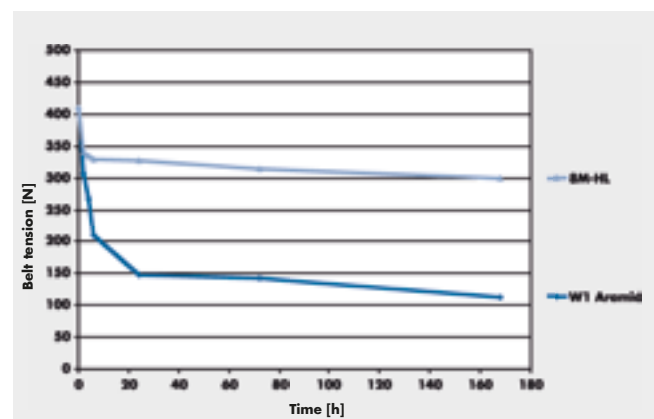

PRODUCT DESCRIPTION

optibelt **OMEGA HL** TIMING BELTS

CHARACTERISTICS, ADVANTAGES AND APPLICATION EXAMPLES

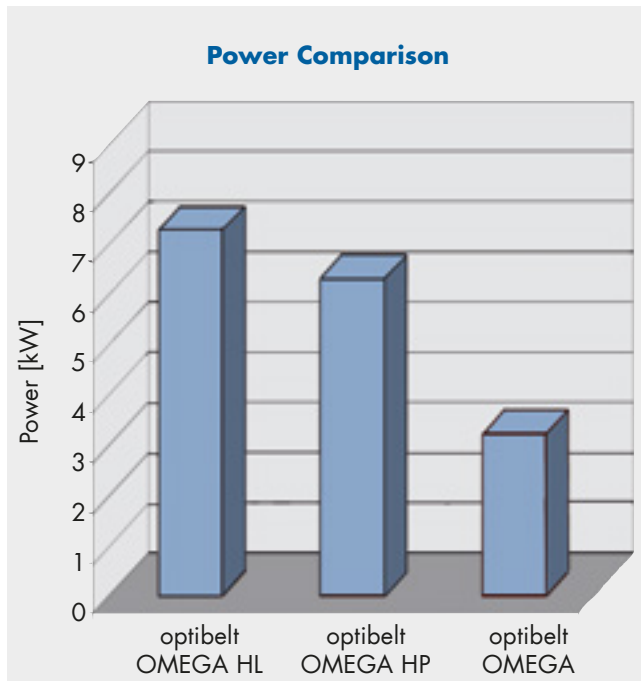

Power ratings overview

Profile and design	8M HL	8M HP	8M
Pitch [mm]	8	8	8
Width [mm]	20	20	20
Pulley diameter [mm]	96.77	96.77	96.77
Speed [min ⁻¹]	600	600	600
Nominal power [kW]	6.86	5.96	2.82

Preferred application areas

- textile machines
- machine tools
- compressors
- printing machines
- wood working machines
- paper machines

Overview of the advantages and characteristics of the optibelt OMEGA HL

- dimensionally stable structure with high flexibility
- very low permanent and elastic stretch of the cord
- friction and abrasion resistant, fabric with high shear strength
- up to 2.5 times higher power transmission capability (an increase of up to 150%) compared to standard OMEGA timing belts
- approx. up to 15% increase of the power transmission compared to the established high performance design OMEGA HP
- suitable for low and high speed, dynamically highly loaded drives
- good resistance to medium and high shock loading
- further extended, very large range of applications
- electrically antistatic to ISO 9563 confirmed on request

Advantages and characteristics of a drive with optibelt OMEGA HL timing belts in these application areas

- reduced installation space compared to OMEGA HP and in particular to OMEGA timing belts in standard design
- reduced costs for belts and pulleys
- better options for drive design
- reduced shaft diameters and smaller bearings
- reduced running noise
- improved efficiency

Significant system cost reduction and high operational reliability for even greater economic efficiency in new drives.

For additional advantages and characteristics, see optibelt OMEGA on page 20.

PRODUCT DESCRIPTION

optibelt **OMEGA HL** TIMING BELTS

STANDARD PRODUCT RANGE

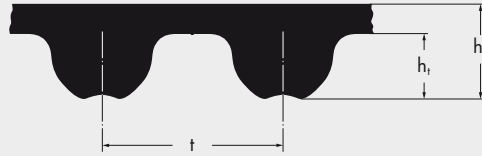

Profile	8M HL
t [mm]	8.0
h _s [mm]	5.4
h _t [mm]	3.2

optibelt OMEGA 8M HL								
Belt designation	Pitch length [mm]	Number of teeth	Belt designation	Pitch length [mm]	Number of teeth	Belt designation	Pitch length [mm]	Number of teeth
288 8MHL•	288.00	36	1064 8MHL•	1064.00	133	2800 8MHL	2800.00	350
352 8MHL•	352.00	44	1080 8MHL•	1080.00	135	3048 8MHL	3048.00	381
376 8MHL•	376.00	47	1096 8MHL•	1096.00	137	3280 8MHL•	3280.00	410
416 8MHL•	416.00	52	1120 8MHL	1120.00	140	3600 8MHL	3600.00	450
424 8MHL•	424.00	53	1128 8MHL•	1128.00	141			
480 8MHL	480.00	60	1160 8MHL•	1160.00	145			
536 8MHL•	536.00	67	1184 8MHL•	1184.00	148			
560 8MHL	560.00	70	1200 8MHL	1200.00	150			
576 8MHL•	576.00	72	1216 8MHL•	1216.00	152			
584 8MHL•	584.00	73	1224 8MHL•	1224.00	153			
600 8MHL•	600.00	75	1248 8MHL•	1248.00	156			
608 8MHL	608.00	76	1280 8MHL	1280.00	160			
632 8MHL•	632.00	79	1304 8MHL	1304.00	163			
640 8MHL	640.00	80	1344 8MHL•	1344.00	168			
656 8MHL	656.00	82	1360 8MHL	1360.00	170			
680 8MHL•	680.00	85	1400 8MHL•	1400.00	175			
712 8MHL•	712.00	89	1424 8MHL	1424.00	178			
720 8MHL	720.00	90	1440 8MHL	1440.00	180			
760 8MHL•	760.00	95	1520 8MHL•	1520.00	190			
776 8MHL	776.00	97	1552 8MHL•	1552.00	194			
784 8MHL	784.00	98	1584 8MHL•	1584.00	198			
800 8MHL	800.00	100	1600 8MHL	1600.00	200			
824 8MHL•	824.00	103	1680 8MHL•	1680.00	210			
840 8MHL•	840.00	105	1696 8MHL•	1696.00	212			
848 8MHL•	848.00	106	1728 8MHL•	1728.00	216			
856 8MHL•	856.00	107	1760 8MHL	1760.00	220			
880 8MHL	880.00	110	1800 8MHL	1800.00	225			
896 8MHL•	896.00	112	1936 8MHL•	1936.00	242			
912 8MHL	912.00	114	2000 8MHL	2000.00	250			
920 8MHL	920.00	115	2240 8MHL	2240.00	280			
960 8MHL	960.00	120	2248 8MHL•	2248.00	281			
976 8MHL•	976.00	122	2272 8MHL•	2272.00	284			
1000 8MHL•	1000.00	125	2400 8MHL	2400.00	300			
1040 8MHL	1040.00	130	2504 8MHL•	2504.00	313			
1056 8MHL•	1056.00	132	2600 8MHL	2600.00	325			

Standard width: 20 mm, 30 mm, 50 mm, 85 mm
(Further sizes and special width ranges on request) • Not available ex stock

Order example: 1200 = 1200 mm pitch length
 TIMING BELTS: optibelt OMEGA HL 1200 8M HL 20 8M HL = profile and design
 20 = 20 mm belt width

PRODUCT DESCRIPTION

optibelt OMEGA HL TIMING BELTS

STANDARD PRODUCT RANGE

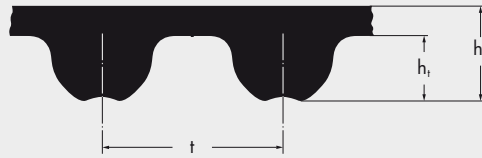

Profile	14M HL
t [mm]	14.0
h _s [mm]	9.5
h _t [mm]	5.6

optibelt OMEGA 14M HL

Belt designation	Pitch length [mm]	Number of teeth	Belt designation	Pitch length [mm]	Number of teeth
966 14MHL	966.00	69	2450 14MHL	2450.00	175
1092 14MHL	1092.00	78	2590 14MHL	2590.00	185
1190 14MHL	1190.00	85	2800 14MHL	2800.00	200
1400 14MHL	1400.00	100	3150 14MHL	3150.00	225
1456 14MHL•	1456.00	104	3360 14MHL	3360.00	240
1610 14MHL	1610.00	115	3500 14MHL	3500.00	250
1778 14MHL	1778.00	127	3850 14MHL	3850.00	275
1890 14MHL	1890.00	135	4326 14MHL	4326.00	309
2100 14MHL	2100.00	150	4578 14MHL	4578.00	327
2310 14MHL	2310.00	165			

Standard width: 40 mm, 55 mm, 85 mm, 115 mm, 170 mm
 (Further sizes and special width ranges on request) • Not available ex stock

Order example:

TIMING BELTS: optibelt OMEGA HL 1400 14M HL 40

1400 = 1400 mm pitch length
 14M HL = profile and design
 40 = 40 mm belt width

PRODUCT DESCRIPTION

optibelt OMEGA FAN POWER TIMING BELTS



Structure

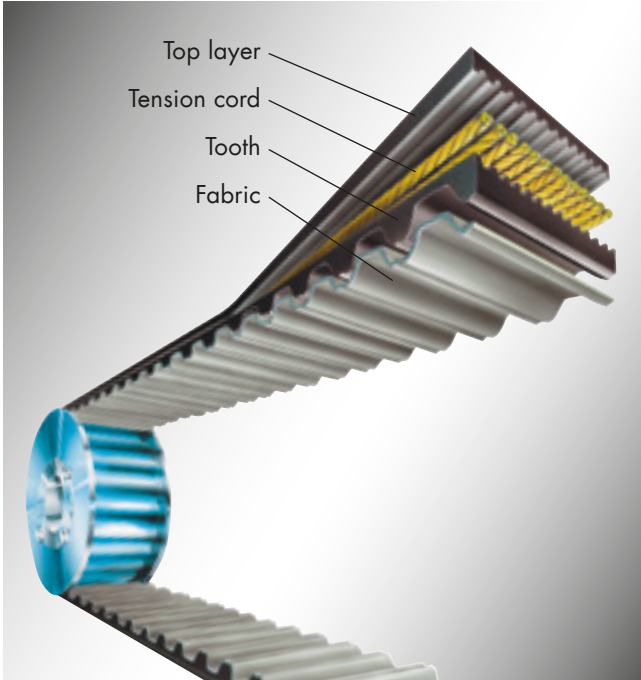

The high performance timing belt for fan drives in the oil industry

Fan drives in the oil industry with medium and high transmission ratios are expected to meet some demanding requirements:

- antistatic according to ISO 9563
- optimised for low tooth meshing wear
- long service life
- maintenance-free
- high level of efficiency
- constant flow of air thanks to synchronous operation
- resistant to external influences such as variations in temperature and moisture

optibelt OMEGA, OMEGA HP, OMEGA HL and OMEGA FAN POWER timing belts are used in optibelt ZRS HTD® timing belt pulleys or in optibelt ZRS RPP® timing belt pulleys. For applications in other pulleys, please consult the OPTIBELT Application Engineering Department.

Top layer

A durable and flexible top layer protects the main body of the belt. The polychloroprene top surface is reinforced with aramid fibres with a degree of resistance to mineral oils and humidity, as well as protection against wear and tear due to friction.

Tension cord

The tension cords are reinforced pairs of counter twisted glass fibres. These tension cords have very high tensile strength, very high flexibility and minimal stretch.

Teeth

The teeth consist of a new compound reinforced with aramid fibres, which guarantee high shear strength. They are shaped and exactly spaced in such a way that they mesh perfectly with the pulley grooves with minimal friction. The dimple in the tooth guarantees quiet running.

Fabric

The specially developed polyamide fabric stands out due to its extraordinarily low frictional coefficient and its low noise characteristics.

It also protects the teeth from early wear and tear and prevents tooth shear.



PRODUCT DESCRIPTION

optibelt OMEGA FAN POWER TIMING BELTS

STANDARD PRODUCT RANGE



(only average values – mm)

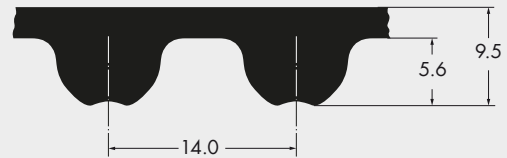
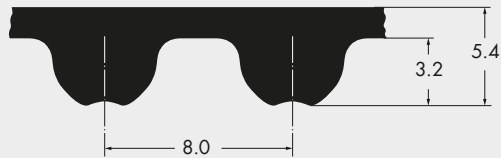

optibelt OMEGA FAN POWER 8M FP			optibelt OMEGA FAN POWER 14M FP		
Belt designation	Pitch length [mm]	Number of teeth	Belt designation	Pitch length [mm]	Number of teeth
2000 8M FP•	2000.00	250	2800 14MFP	2800.00	200
2240 8M FP•	2240.00	280	3150 14MFP	3150.00	225
2400 8M FP•	2400.00	300	3360 14MFP	3360.00	240
2600 8M FP•	2600.00	325	3500 14MFP	3500.00	250
2800 8M FP•	2800.00	350	3850 14MFP	3850.00	275
			4326 14MFP	4326.00	309
			4578 14MFP	4578.00	327

<p>Standard width: 30 mm, 50 mm, 85 mm (Further sizes and special width ranges on request) • Not available ex stock</p>	<p>Standard width: 55 mm, 85 mm (Further sizes and special width ranges on request)</p>
--	--

Order example:

TIMING BELTS: optibelt OMEGA FAN POWER 2000 8M FP 30

2000 = 2000 mm pitch length
8M FP = profile and design
30 = 30 mm belt width

PRODUCT DESCRIPTION

optibelt OMEGA HP TIMING BELTS



Structure

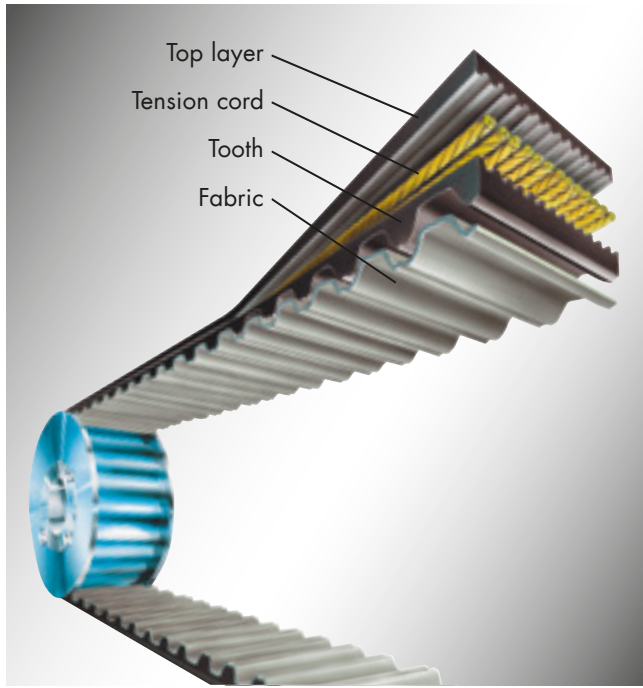

Top layer

A durable and flexible top layer protects the tension cord from external influences. In addition, the polychloroprene compound is reinforced with aramid fibres and has a degree of resistance to mineral oils and humidity as well as protection from wear and tear due to friction.

Tension cord

The tension cords are reinforced pairs of counter twisted glass fibres. These tension cords have very high tensile strength, very high flexibility and minimal stretch.

Teeth

The teeth consist of a new compound reinforced with aramid fibres, which guarantee high shear strength. They are shaped and exactly spaced in such a way that they mesh perfectly with the pulley teeth with minimal friction. The indent in the tooth guarantees quiet running.

Fabric

The specially developed polyamide fabric stands out due to its extraordinarily low frictional coefficient and its low noise characteristics.

It also protects the teeth from early wear and tear and prevents tooth shear.

The high performance timing belt for high load, high speed machine drives

Compact synchronous drives are used in the whole field of mechanical drive engineering. High power transmission capability, good running characteristics and high operational safety are only some of the demands made on timing belts. Modern manufacturing techniques and quality inspections during all processing stages ensure products with highest reliability. optibelt OMEGA HP high performance timing belts have been especially developed for high load, low and high speed drives that are evenly loaded without heavy shock. Improved materials and optimised production form the basis for this very high performance range.

optibelt OMEGA, OMEGA HP and OMEGA HL timing belts are used in optibelt ZRS HTD® timing belt pulleys or in optibelt ZRS RPP® timing belt pulleys. For applications using other pulleys, please contact the OPTIBELT Application Engineering Department.

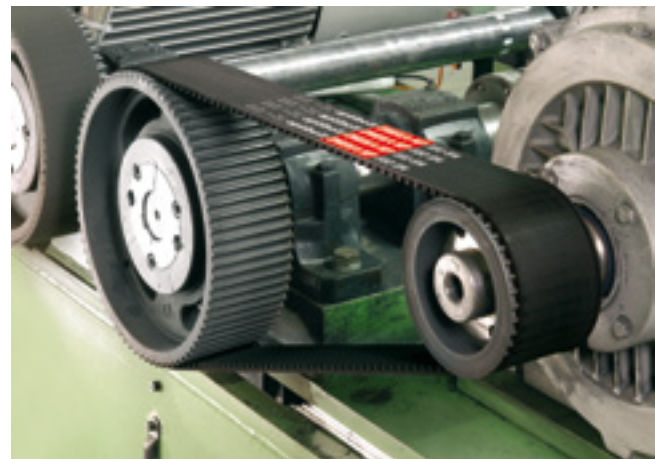

Application example: test bench

The new high performance timing belt optibelt OMEGA 5M HP

In the field of the high performance timing belts the optibelt OMEGA 5M HP has been developed for small pulley diameters, short centre distances and high speeds. The optibelt OMEGA 5M HP transmits up to 3 times the power of an optibelt OMEGA 5M (an increase in power of up to 200%). The performance level of the optibelt OMEGA 5M HP roughly corresponds with the level of the considerably larger section optibelt OMEGA 8M – with the same pulley diameters.

PRODUCT DESCRIPTION

optibelt OMEGA HP TIMING BELTS

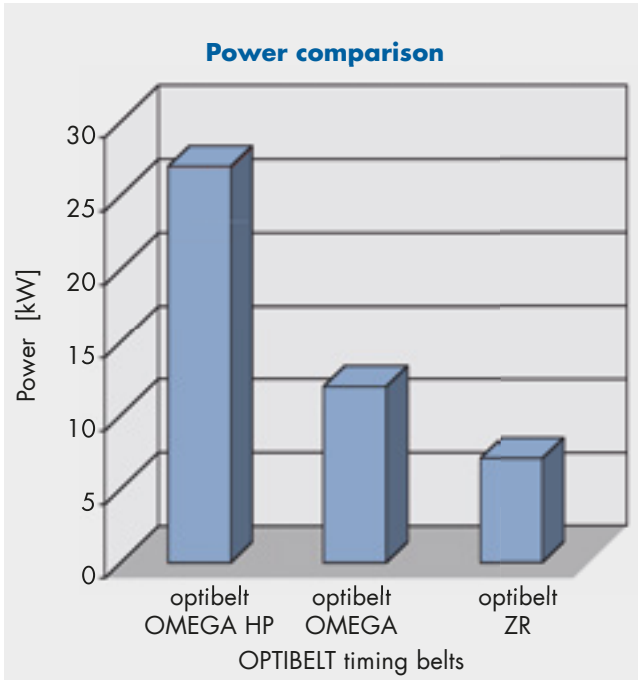

Power ratings overview

Profile and design	8M HP	8M	H
Pitch [mm]	8	8	12.7
Width [mm]	20	20	19.05
Pulley diameter [mm]	96.77	96.77	97.02
Speed [min ⁻¹]	2850	2850	2850
Nominal power [kW]	24.4	10.8	6.0

Preferred application areas

- textile machines
- machine tools
- compressors
- printing machines
- wood working machines
- paper machines

Overview of the advantages and characteristics of the optibelt OMEGA HP

- dimensionally stable structure with high flexibility
- low permanent and elastic stretch of the cord
- friction and abrasion resistant fabric with high shear strength
- approximately double power transmission capability (profile 5M HP approximately trebles the power transmission capacity) compared to OMEGA timing belts in their standard design
- suitable for low and high speed, high load drives
- good resistance and smooth operation, low and medium shock load
- large range of applications
- electrical antistatic according to ISO 9563 confirmed on request

Advantages and characteristics of a drive with optibelt OMEGA HP timing belts in these application areas

- considerably reduced drive volume compared to OMEGA timing belts in standard design
- reduced costs for belts and pulleys
- greater options for drive design
- reduced shaft diameters and smaller bearings
- reduced running noise levels
- improved efficiency

Significant system cost reduction and high operational reliability for even greater economic efficiency in new drives

For additional advantages and characteristics, see optibelt OMEGA on page 20.

PRODUCT DESCRIPTION

optibelt **OMEGA HP** TIMING BELTS

STANDARD PRODUCT RANGE

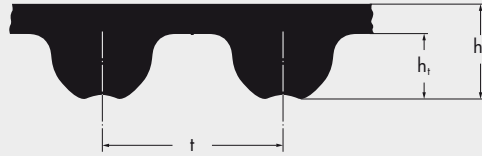

Profile	3M HP
t [mm]	3.0
h _s [mm]	2.3
h _t [mm]	1.1

optibelt OMEGA 3M HP								
Belt designation	Pitch length [mm]	Number of teeth	Belt designation	Pitch length [mm]	Number of teeth	Belt designation	Pitch length [mm]	Number of teeth
111 3MHP•	111.00	37	294 3MHP•	294.00	98	600 3MHP•	600.00	200
129 3MHP•	129.00	43	300 3MHP	300.00	100	606 3MHP•	606.00	202
141 3MHP•	141.00	47	312 3MHP	312.00	104	615 3MHP•	615.00	205
144 3MHP	144.00	48	315 3MHP•	315.00	105	633 3MHP•	633.00	211
150 3MHP•	150.00	50	318 3MHP	318.00	106	669 3MHP	669.00	223
159 3MHP•	159.00	53	330 3MHP	330.00	110	675 3MHP•	675.00	225
165 3MHP•	165.00	55	333 3MHP•	333.00	111	711 3MHP•	711.00	237
168 3MHP•	168.00	56	339 3MHP•	339.00	113	738 3MHP•	738.00	246
171 3MHP•	171.00	57	345 3MHP•	345.00	115	804 3MHP•	804.00	268
174 3MHP	174.00	58	357 3MHP	357.00	119	816 3MHP•	816.00	272
177 3MHP	177.00	59	363 3MHP	363.00	121	843 3MHP•	843.00	281
180 3MHP•	180.00	60	366 3MHP•	366.00	122	882 3MHP•	882.00	294
183 3MHP•	183.00	61	384 3MHP	384.00	128	888 3MHP•	888.00	296
186 3MHP•	186.00	62	390 3MHP•	390.00	130	1062 3MHP•	1062.00	354
192 3MHP•	192.00	64	420 3MHP	420.00	140	1569 3MHP•	1569.00	523
195 3MHP•	195.00	65	426 3MHP•	426.00	142	1587 3MHP•	1587.00	529
201 3MHP	201.00	67	435 3MHP•	435.00	145	1692 3MHP•	1692.00	564
204 3MHP•	204.00	68	447 3MHP	447.00	149			
207 3MHP	207.00	69	462 3MHP•	462.00	154			
210 3MHP	210.00	70	474 3MHP	474.00	158			
213 3MHP•	213.00	71	480 3MHP•	480.00	160			
219 3MHP•	219.00	73	486 3MHP•	486.00	162			
225 3MHP	225.00	75	495 3MHP•	495.00	165			
237 3MHP	237.00	79	501 3MHP	501.00	167			
240 3MHP	240.00	80	513 3MHP	513.00	171			
246 3MHP•	246.00	82	519 3MHP•	519.00	173			
249 3MHP•	249.00	83	522 3MHP•	522.00	174			
252 3MHP•	252.00	84	525 3MHP•	525.00	175			
255 3MHP	255.00	85	531 3MHP•	531.00	177			
267 3MHP•	267.00	89	537 3MHP•	537.00	179			
276 3MHP	276.00	92	558 3MHP•	558.00	186			
282 3MHP•	282.00	94	564 3MHP•	564.00	188			
285 3MHP	285.00	95	570 3MHP•	570.00	190			
288 3MHP•	288.00	96	582 3MHP•	582.00	194			
291 3MHP•	291.00	97	597 3MHP	597.00	199			

Standard width: 6 mm, 9 mm, 15 mm
 (Further sizes and special width ranges on request) • Not available ex stock

Order example:

TIMING BELTS: optibelt OMEGA HP 225 3M HP 9

225 = 225 mm pitch length
 3M HP = profile and design
 9 = 9 mm belt width

PRODUCT DESCRIPTION

optibelt **OMEGA HP** TIMING BELTS

STANDARD PRODUCT RANGE

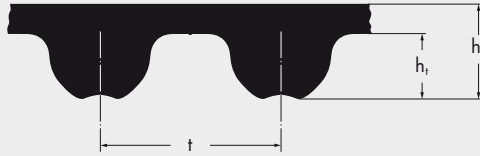

Profile	5M HP
t [mm]	5.0
h _s [mm]	3.4
h _t [mm]	1.9

optibelt OMEGA 5M HP								
Belt designation	Pitch length [mm]	Number of teeth	Belt designation	Pitch length [mm]	Number of teeth	Belt designation	Pitch length [mm]	Number of teeth
180 5MHP	180.00	36	575 5MHP•	575.00	115	1000 5MHP	1000.00	200
225 5MHP	225.00	45	580 5MHP•	580.00	116	1025 5MHP•	1025.00	205
255 5MHP	255.00	51	600 5MHP	600.00	120	1035 5MHP•	1035.00	207
265 5MHP	265.00	53	610 5MHP•	610.00	122	1050 5MHP	1050.00	210
270 5MHP•	270.00	54	615 5MHP•	615.00	123	1100 5MHP•	1100.00	220
275 5MHP•	275.00	55	630 5MHP	630.00	126	1125 5MHP	1125.00	225
280 5MHP•	280.00	56	635 5MHP	635.00	127	1135 5MHP•	1135.00	227
295 5MHP•	295.00	59	640 5MHP•	640.00	128	1200 5MHP•	1200.00	240
300 5MHP•	300.00	60	645 5MHP	645.00	129	1270 5MHP•	1270.00	254
305 5MHP	305.00	61	650 5MHP•	650.00	130	1380 5MHP•	1380.00	276
325 5MHP	325.00	65	665 5MHP	665.00	133	1400 5MHP•	1400.00	280
330 5MHP	330.00	66	670 5MHP•	670.00	134	1420 5MHP	1420.00	284
340 5MHP•	340.00	68	700 5MHP	700.00	140	1425 5MHP•	1425.00	285
350 5MHP	350.00	70	710 5MHP	710.00	142	1500 5MHP•	1500.00	300
360 5MHP	360.00	72	720 5MHP•	720.00	144	1595 5MHP•	1595.00	319
365 5MHP•	365.00	73	740 5MHP	740.00	148	1690 5MHP•	1690.00	338
370 5MHP•	370.00	74	750 5MHP•	750.00	150	1790 5MHP•	1790.00	358
375 5MHP	375.00	75	755 5MHP	755.00	151	1870 5MHP•	1870.00	374
385 5MHP•	385.00	77	775 5MHP•	775.00	155	1895 5MHP•	1895.00	379
400 5MHP	400.00	80	790 5MHP•	790.00	158	2000 5MHP•	2000.00	400
415 5MHP•	415.00	83	800 5MHP	800.00	160	2110 5MHP•	2110.00	422
420 5MHP•	420.00	84	825 5MHP•	825.00	165	2350 5MHP•	2350.00	470
425 5MHP	425.00	85	830 5MHP•	830.00	166	2525 5MHP•	2525.00	505
450 5MHP	450.00	90	835 5MHP	835.00	167			
460 5MHP•	460.00	92	850 5MHP•	850.00	170			
475 5MHP	475.00	95	860 5MHP•	860.00	172			
490 5MHP•	490.00	98	890 5MHP	890.00	178			
500 5MHP	500.00	100	900 5MHP	900.00	180			
520 5MHP•	520.00	104	925 5MHP	925.00	185			
525 5MHP	525.00	105	935 5MHP•	935.00	187			
535 5MHP	535.00	107	940 5MHP•	940.00	188			
540 5MHP•	540.00	108	950 5MHP	950.00	190			
550 5MHP	550.00	110	965 5MHP•	965.00	193			
560 5MHP•	560.00	112	975 5MHP•	975.00	195			
565 5MHP	565.00	113	980 5MHP•	980.00	196			

Standard width: 9 mm, 15 mm, 25 mm
 (Further sizes and special width ranges on request) • Not available ex stock

Order example:

TIMING BELTS: optibelt OMEGA HP 1000 5M HP 25

1000 = 1000 mm pitch length
 5M HP = profile and design
 25 = 25 mm belt width

PRODUCT DESCRIPTION

optibelt **OMEGA HP** TIMING BELTS

STANDARD PRODUCT RANGE

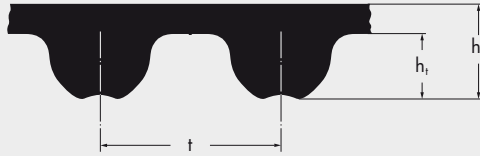

Profile	8M HP
t [mm]	8.0
h _s [mm]	5.4
h _t [mm]	3.2

optibelt OMEGA 8M HP								
Belt designation	Pitch length [mm]	Number of teeth	Belt designation	Pitch length [mm]	Number of teeth	Belt designation	Pitch length [mm]	Number of teeth
288 8MHP•	288.00	36	1000 8MHP	1000.00	125	2000 8MHP	2000.00	250
352 8MHP•	352.00	44	1040 8MHP	1040.00	130	2080 8MHP•	2080.00	260
376 8MHP•	376.00	47	1056 8MHP•	1056.00	132	2104 8MHP•	2104.00	263
416 8MHP•	416.00	52	1064 8MHP	1064.00	133	2240 8MHP	2240.00	280
424 8MHP	424.00	53	1080 8MHP	1080.00	135	2248 8MHP	2248.00	281
480 8MHP	480.00	60	1096 8MHP•	1096.00	137	2272 8MHP	2272.00	284
512 8MHP	512.00	64	1120 8MHP	1120.00	140	2400 8MHP	2400.00	300
520 8MHP	520.00	65	1128 8MHP	1128.00	141	2504 8MHP	2504.00	313
536 8MHP•	536.00	67	1160 8MHP	1160.00	145	2600 8MHP	2600.00	325
560 8MHP	560.00	70	1184 8MHP•	1184.00	148	2800 8MHP	2800.00	350
576 8MHP	576.00	72	1200 8MHP	1200.00	150	3048 8MHP	3048.00	381
584 8MHP•	584.00	73	1216 8MHP	1216.00	152	3280 8MHP	3280.00	410
600 8MHP	600.00	75	1224 8MHP	1224.00	153	3600 8MHP	3600.00	450
608 8MHP	608.00	76	1248 8MHP•	1248.00	156			
624 8MHP•	624.00	78	1256 8MHP	1256.00	157			
632 8MHP	632.00	79	1264 8MHP•	1264.00	158			
640 8MHP	640.00	80	1280 8MHP	1280.00	160			
656 8MHP	656.00	82	1304 8MHP	1304.00	163			
680 8MHP	680.00	85	1328 8MHP•	1328.00	166			
712 8MHP	712.00	89	1344 8MHP•	1344.00	168			
720 8MHP	720.00	90	1360 8MHP	1360.00	170			
760 8MHP	760.00	95	1400 8MHP	1400.00	175			
776 8MHP	776.00	97	1424 8MHP	1424.00	178			
784 8MHP	784.00	98	1440 8MHP	1440.00	180			
800 8MHP	800.00	100	1520 8MHP	1520.00	190			
824 8MHP	824.00	103	1552 8MHP	1552.00	194			
840 8MHP	840.00	105	1584 8MHP•	1584.00	198			
848 8MHP	848.00	106	1600 8MHP	1600.00	200			
856 8MHP	856.00	107	1680 8MHP•	1680.00	210			
880 8MHP	880.00	110	1696 8MHP	1696.00	212			
896 8MHP	896.00	112	1728 8MHP•	1728.00	216			
912 8MHP	912.00	114	1760 8MHP	1760.00	220			
920 8MHP	920.00	115	1800 8MHP	1800.00	225			
960 8MHP	960.00	120	1904 8MHP•	1904.00	238			
976 8MHP	976.00	122	1936 8MHP	1936.00	242			

Standard width: 20 mm, 30 mm, 50 mm, 85 mm
 (Further sizes and special width ranges on request) • Not available ex stock

Order example: 1200 = 1200 mm pitch length
 8M HP = profile and design
 20 = 20 mm belt width

TIMING BELTS: optibelt OMEGA HP 1200 8M HP 20

PRODUCT DESCRIPTION

optibelt **OMEGA HP** TIMING BELTS

STANDARD PRODUCT RANGE

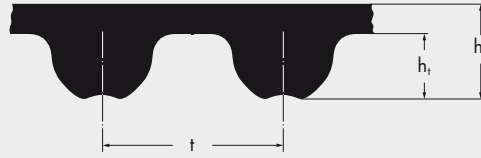

Profile	14M HP
t [mm]	14.0
h _s [mm]	9.5
h _t [mm]	5.6

optibelt OMEGA 14M HP					
Belt designation	Pitch length [mm]	Number of teeth	Belt designation	Pitch length [mm]	Number of teeth
966 14MHP	966.00	69	2800 14MHP	2800.00	200
1092 14MHP	1092.00	78	3150 14MHP	3150.00	225
1190 14MHP	1190.00	85	3360 14MHP	3360.00	240
1344 14MHP•	1344.00	96	3500 14MHP	3500.00	250
1400 14MHP	1400.00	100	3850 14MHP	3850.00	275
1456 14MHP•	1456.00	104	4326 14MHP	4326.00	309
1512 14MHP•	1512.00	108	4578 14MHP	4578.00	327
1610 14MHP	1610.00	115			
1680 14MHP•	1680.00	120			
1778 14MHP	1778.00	127			
1890 14MHP	1890.00	135			
2100 14MHP	2100.00	150			
2310 14MHP	2310.00	165			
2450 14MHP	2450.00	175			
2590 14MHP	2590.00	185			

Standard width: 40 mm, 55 mm, 85 mm, 115 mm, 170 mm
(Further sizes and special width ranges on request) • Not available ex stock

Order example: 1400 = 1400 mm pitch length
 TIMING BELTS: optibelt OMEGA HP 1400 14M HP 55 14M HP = profile and design
 55 = 55 mm belt width

PRODUCT DESCRIPTION

optibelt OMEGA TIMING BELTS



Structure

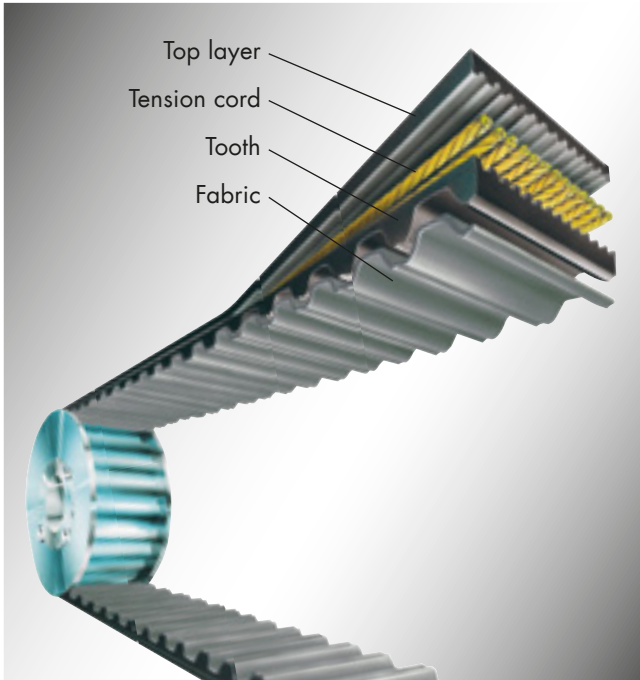

Fabric

The polyamide fabric protects the teeth from premature wear and tooth root cracking. At the same time, the low coefficient of friction lowers the operating temperature and helps to reduce the running noise.

High performance optibelt OMEGA timing belts are the result of a continuing development process. Operational experience with optibelt ZR and optibelt HTD® has been applied to this belt generation. Endless optibelt OMEGA timing belts set the standard for synchronous performance and for positioning drives.

The geometry of the optibelt OMEGA tooth profile has been developed to run in the established, curvilinear timing belt pulleys. optibelt OMEGA timing belts can be used in 3M, 5M, 8M and 14M HTD® pulley profiles. optibelt ZRS HTD® timing belt pulleys are standard items in our range with pilot bores or bored for optibelt TB taper bushes. In addition, all OMEGA timing belts can also be used in RPP® timing belt pulleys. Special timing belt pulleys for optibelt OMEGA timing belts are not required.

Top layer

The belt top layer consists of a flexible polychloroprene compound which protects the tension cord from external influences. In addition, it offers limited resistance to mineral oils and humidity as well as protection from frictional wear and tear.

Tension cord

The tension member is composed of a pair of counter twisted glass fibre cords. These tension cords have high tensile strength, very high flexibility and very low stretch.

Teeth

Just like the belt top layer, the teeth consist of a polychloroprene compound guaranteeing high shear strength. The dimples in the teeth promote quiet running.



Application example: lawn mowers

Overview of the advantages and characteristics

- synchronous speed
- highest precision
- perceptibly lower noise level due to the OMEGA tooth profile
- use in standard HTD® and RPP® timing belt pulleys
- maintenance-free
- temperature resistant from -30 °C to +100 °C
- efficiency of up to 98 %

PRODUCT DESCRIPTION

optibelt **OMEGA** TIMING BELTS

STANDARD PRODUCT RANGE

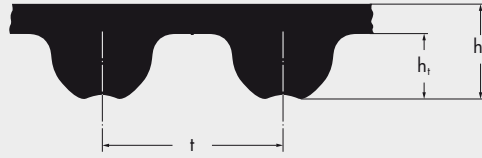

Profile	2M
t [mm]	2.0
h _s [mm]	1.3
h _t [mm]	0.7

optibelt OMEGA 2M					
Belt designation	Pitch length [mm]	Number of teeth	Belt designation	Pitch length [mm]	Number of teeth
74 2M•	74.00	37	310 2M•	310.00	155
90 2M•	90.00	45	314 2M•	314.00	157
100 2M•	100.00	50	318 2M•	318.00	159
104 2M•	104.00	52	328 2M•	328.00	164
112 2M•	112.00	56	330 2M•	330.00	165
118 2M•	118.00	59	336 2M•	336.00	168
120 2M•	120.00	60	340 2M•	340.00	170
124 2M•	124.00	62	368 2M•	368.00	184
130 2M•	130.00	65	370 2M•	370.00	185
140 2M•	140.00	70	386 2M•	386.00	193
148 2M•	148.00	74	392 2M•	392.00	196
158 2M•	158.00	79	406 2M•	406.00	203
180 2M•	180.00	90	426 2M•	426.00	213
184 2M•	184.00	92	448 2M•	448.00	224
188 2M•	188.00	94	558 2M•	558.00	279
192 2M•	192.00	96	560 2M•	560.00	280
200 2M•	200.00	100	710 2M•	710.00	355
208 2M•	208.00	104	930 2M•	930.00	465
210 2M•	210.00	105	984 2M•	984.00	492
216 2M•	216.00	108	1066 2M•	1066.00	533
224 2M•	224.00	112	1224 2M•	1224.00	612
232 2M•	232.00	116			
250 2M•	250.00	125			
256 2M•	256.00	128			
266 2M•	266.00	133			
274 2M•	274.00	137			
280 2M•	280.00	140			
288 2M•	288.00	144			
304 2M•	304.00	152			
308 2M•	308.00	154			

Standard width: 3 mm, 6 mm, 9 mm
 • Not available ex stock

Order example:
 TIMING BELTS: optibelt OMEGA 180 2M 6

180 = 180 mm pitch length
 2M = profile
 6 = 6 mm belt width

PRODUCT DESCRIPTION

optibelt **OMEGA** TIMING BELTS

STANDARD PRODUCT RANGE

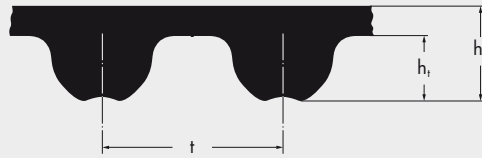

Profile	3M
t [mm]	3.0
h _s [mm]	2.3
h _t [mm]	1.1

optibelt OMEGA 3M					
Belt designation	Pitch length [mm]	Number of teeth	Belt designation	Pitch length [mm]	Number of teeth
111 3M	111.00	37	255 3M	255.00	85
117 3M (HTD)•	117.00	39	267 3M	267.00	89
120 3M (HTD)•	120.00	40	276 3M	276.00	92
123 3M (HTD)•	123.00	41	282 3M•	282.00	94
126 3M (HTD)•	126.00	42	285 3M	285.00	95
129 3M	129.00	43	288 3M	288.00	96
141 3M	141.00	47	291 3M	291.00	97
144 3M	144.00	48	294 3M	294.00	98
150 3M	150.00	50	300 3M	300.00	100
156 3M (HTD)•	156.00	52	306 3M (HTD)•	306.00	102
159 3M	159.00	53	312 3M	312.00	104
165 3M	165.00	55	315 3M	315.00	105
168 3M	168.00	56	318 3M	318.00	106
171 3M	171.00	57	330 3M	330.00	110
174 3M	174.00	58	333 3M	333.00	111
177 3M	177.00	59	336 3M (HTD)	336.00	112
180 3M	180.00	60	339 3M	339.00	113
183 3M	183.00	61	345 3M	345.00	115
186 3M	186.00	62	357 3M	357.00	119
192 3M	192.00	64	363 3M	363.00	121
195 3M	195.00	65	366 3M	366.00	122
201 3M	201.00	67	384 3M	384.00	128
204 3M	204.00	68	390 3M	390.00	130
207 3M	207.00	69	411 3M	411.00	137
210 3M	210.00	70	420 3M	420.00	140
213 3M	213.00	71	426 3M	426.00	142
216 3M (HTD)	216.00	72	435 3M•	435.00	145
219 3M•	219.00	73	447 3M	447.00	149
225 3M	225.00	75	462 3M	462.00	154
237 3M•	237.00	79	474 3M	474.00	158
240 3M	240.00	80	477 3M (HTD)•	477.00	159
243 3M (HTD)•	243.00	81	480 3M	480.00	160
246 3M	246.00	82	486 3M	486.00	162
249 3M•	249.00	83	489 3M (HTD)•	489.00	163
252 3M	252.00	84	495 3M	495.00	165

Standard width: 6 mm, 9 mm, 15 mm
• Not available ex stock

Order example: 150 = 150 mm pitch length
3M = profile
15 = 15 mm belt width

TIMING BELTS: optibelt OMEGA 150 3M 15

PRODUCT DESCRIPTION

optibelt **OMEGA** TIMING BELTS

STANDARD PRODUCT RANGE

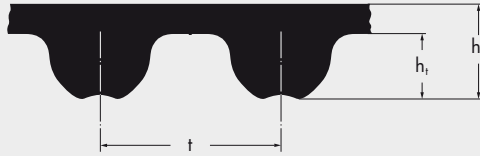

Profile	3M
t [mm]	3.0
h _s [mm]	2.3
h _t [mm]	1.1

optibelt OMEGA 3M					
Belt designation	Pitch length [mm]	Number of teeth	Belt designation	Pitch length [mm]	Number of teeth
501 3M	501.00	167	1062 3M	1062.00	354
513 3M	513.00	171	1068 3M (HTD)•	1068.00	356
519 3M	519.00	173	1071 3M (HTD)	1071.00	357
522 3M	522.00	174	1125 3M (HTD)•	1125.00	375
525 3M	525.00	175	1176 3M (HTD)•	1176.00	392
531 3M	531.00	177	1245 3M (HTD)•	1245.00	415
537 3M	537.00	179	1263 3M (HTD)	1263.00	421
558 3M	558.00	186	1500 3M (HTD)•	1500.00	500
564 3M	564.00	188	1530 3M (HTD)•	1530.00	510
570 3M	570.00	190	1569 3M	1569.00	523
582 3M	582.00	194	1587 3M•	1587.00	529
591 3M (HTD)•	591.00	197	1692 3M•	1692.00	564
594 3M (HTD)•	594.00	198	1863 3M (HTD)	1863.00	621
597 3M	597.00	199			
600 3M	600.00	200			
606 3M	606.00	202			
612 3M (HTD)•	612.00	204			
615 3M	615.00	205			
633 3M	633.00	211			
648 3M (HTD)•	648.00	216			
669 3M	669.00	223			
672 3M (HTD)•	672.00	224			
675 3M	675.00	225			
708 3M (HTD)•	708.00	236			
711 3M	711.00	237			
738 3M	738.00	246			
753 3M (HTD)	753.00	251			
804 3M	804.00	268			
816 3M	816.00	272			
843 3M	843.00	281			
882 3M	882.00	294			
888 3M	888.00	296			
945 3M (HTD)	945.00	315			
960 3M (HTD)•	960.00	320			
1041 3M (HTD)•	1041.00	347			

Standard width: 6 mm, 9 mm, 15 mm
• Not available ex stock

Order example: TIMING BELTS: optibelt OMEGA 150 3M 15

150 = 150 mm pitch length
3M = profile
15 = 15 mm belt width

PRODUCT DESCRIPTION

optibelt **OMEGA** TIMING BELTS

STANDARD PRODUCT RANGE

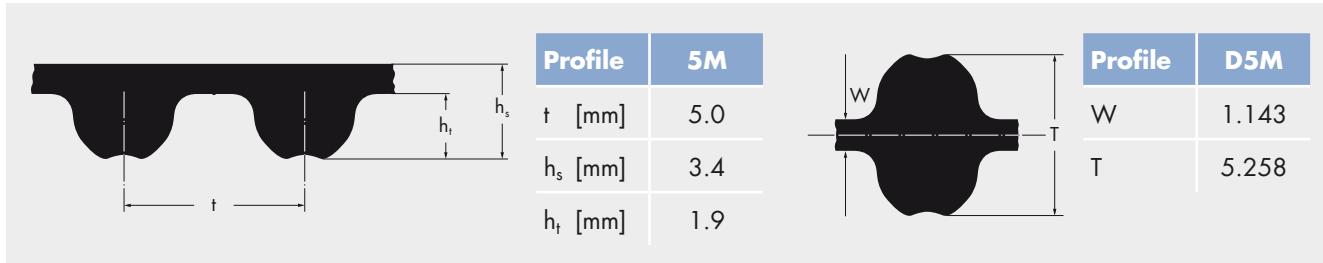

optibelt OMEGA 5M					
Belt designation	Pitch length [mm]	Number of teeth	Belt designation	Pitch length [mm]	Number of teeth
120 5M (HTD)	120.00	24	560 5M	560.00	112
180 5M	180.00	36	565 5M▲	565.00	113
225 5M	225.00	45	575 5M	575.00	115
255 5M	255.00	51	580 5M	580.00	116
265 5M	265.00	53	600 5M▲	600.00	120
270 5M	270.00	54	610 5M	610.00	122
275 5M	275.00	55	615 5M▲	615.00	123
280 5M	280.00	56	620 5M	620.00	124
295 5M	295.00	59	625 5M	625.00	125
300 5M	300.00	60	630 5M▲	630.00	126
305 5M	305.00	61	635 5M▲	635.00	127
325 5M	325.00	65	640 5M	640.00	128
330 5M	330.00	66	645 5M	645.00	129
340 5M	340.00	68	650 5M	650.00	130
345 5M (HTD)	345.00	69	655 5M	655.00	131
350 5M	350.00	70	665 5M▲	665.00	133
360 5M	360.00	72	670 5M	670.00	134
365 5M	365.00	73	700 5M▲	700.00	140
370 5M	370.00	74	710 5M▲	710.00	142
375 5M	375.00	75	720 5M	720.00	144
385 5M	385.00	77	740 5M▲	740.00	148
400 5M	400.00	80	745 5M•	745.00	149
415 5M	415.00	83	750 5M	750.00	150
420 5M	420.00	84	755 5M▲	755.00	151
425 5M	425.00	85	775 5M	775.00	155
450 5M	450.00	90	790 5M	790.00	158
460 5M	460.00	92	800 5M▲	800.00	160
475 5M	475.00	95	810 5M•	810.00	162
490 5M	490.00	98	825 5M	825.00	165
500 5M	500.00	100	830 5M	830.00	166
520 5M	520.00	104	835 5M▲	835.00	167
525 5M	525.00	105	845 5M•	845.00	169
535 5M	535.00	107	850 5M	850.00	170
540 5M	540.00	108	860 5M	860.00	172
550 5M	550.00	110	870 5M•	870.00	174

Standard width: 9 mm, 15 mm, 25 mm
 • Not available ex stock
 ▲ Double-sided available in HTD®

Order example: 1200 = 1200 mm pitch length
 5M = profile
 15 = 15 mm belt width

TIMING BELTS: optibelt OMEGA 1200 5M 15

PRODUCT DESCRIPTION

optibelt **OMEGA** TIMING BELTS

STANDARD PRODUCT RANGE

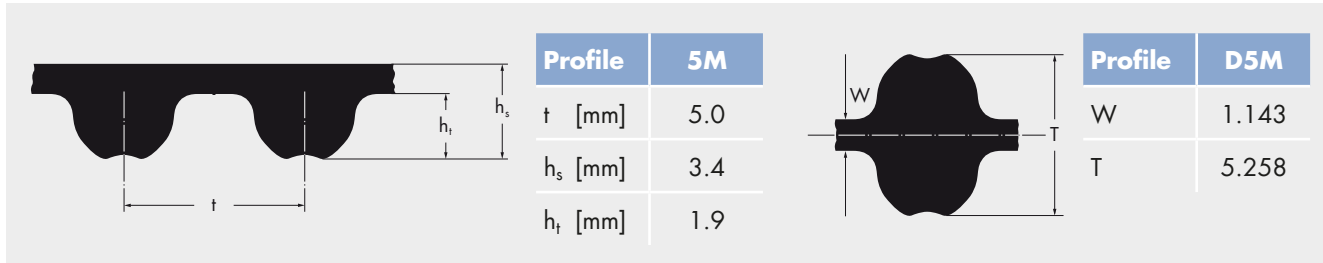

optibelt OMEGA 5M					
Belt designation	Pitch length [mm]	Number of teeth	Belt designation	Pitch length [mm]	Number of teeth
890 5M▲	890.00	178	2250 5M	2250.00	450
900 5M▲	900.00	180	2350 5M	2350.00	470
920 5M●	920.00	184	2525 5M	2525.00	505
925 5M	925.00	185			
935 5M	935.00	187			
940 5M	940.00	188			
950 5M	950.00	190			
960 5M●	960.00	192			
965 5M	965.00	193			
975 5M	975.00	195			
980 5M	980.00	196			
985 5M●	985.00	197			
1000 5M▲	1000.00	200			
1025 5M	1025.00	205			
1035 5M	1035.00	207			
1050 5M▲	1050.00	210			
1100 5M	1100.00	220			
1125 5M▲	1125.00	225			
1135 5M	1135.00	227			
1200 5M▲	1200.00	240			
1270 5M	1270.00	254			
1350 5M●	1350.00	270			
1380 5M	1380.00	276			
1400 5M	1400.00	280			
1420 5M	1420.00	284			
1425 5M	1425.00	285			
1500 5M	1500.00	300			
1595 5M	1595.00	319			
1690 5M	1690.00	338			
1790 5M	1790.00	358			
1800 5M	1800.00	360			
1870 5M	1870.00	374			
1895 5M	1895.00	379			
2000 5M	2000.00	400			
2110 5M	2110.00	422			

Standard width: 9 mm, 15 mm, 25 mm
 • Not available ex stock
 ▲ Double-sided available in HTD®

Order example: 1200 = 1200 mm pitch length
 5M = profile
 15 = 15 mm belt width

TIMING BELTS: optibelt OMEGA 1200 5M 15

PRODUCT DESCRIPTION

optibelt **OMEGA** TIMING BELTS

STANDARD PRODUCT RANGE

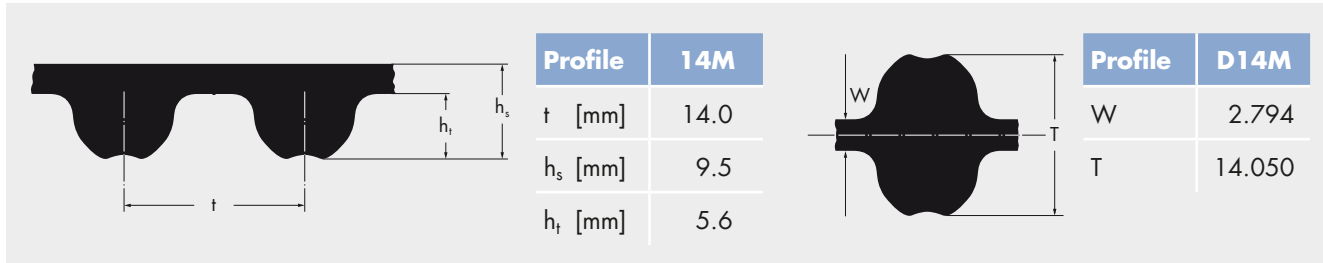

optibelt OMEGA 14M					
Belt designation	Pitch length [mm]	Number of teeth	Belt designation	Pitch length [mm]	Number of teeth
966 14M▲	966.00	69	2800 14M	2800.00	200
1092 14M	1092.00	78	3150 14M	3150.00	225
1190 14M▲	1190.00	85	3360 14M	3360.00	240
1344 14M	1344.00	96	3500 14M	3500.00	250
1400 14M▲	1400.00	100	3850 14M	3850.00	275
1456 14M	1456.00	104	4004 14M*•	4004.00	286
1512 14M	1512.00	108	4326 14M	4326.00	309
1610 14M▲	1610.00	115	4578 14M	4578.00	327
1680 14M	1680.00	120			
1778 14M▲	1778.00	127			
1890 14M▲	1890.00	135			
2100 14M▲	2100.00	150			
2310 14M▲	2310.00	165			
2450 14M	2450.00	175			
2590 14M	2590.00	185			

Standard width: 40 mm, 55 mm, 85 mm, 115 mm, 170 mm
 • Not available ex stock
 ▲ Double-sided available in HTD® * Profile on request

Order example: 1400 = 1400 mm pitch length
 14M = profile
 55 = 55 mm belt width

TIMING BELTS: optibelt OMEGA 1400 14M 55

PRODUCT DESCRIPTION

optibelt ZR TIMING BELTS

ISO 5296



Structure

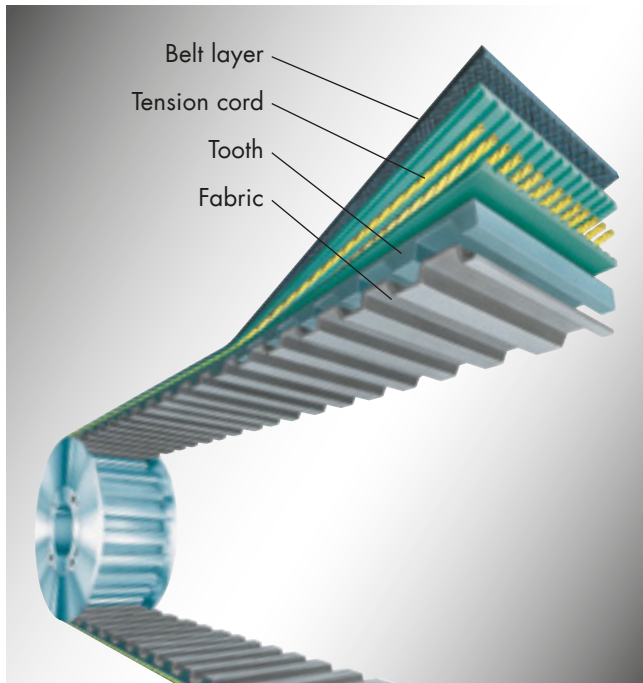

Top layer

A flexible belt backing embeds the tension element and supports it against the reverse idlers. The top layer consists of a flexible high quality chloroprene compound. This protects the tension cord from oil, humidity, friction and wear and tear.

This top layer has some inherent resistance to mineral oils, but not to vegetable oils and water soluble cooling and cutting oils.

Tension cord

The tension cord is a continuous, spirally wound glass fibre. This material has a high tensile strength and is extremely flexible. The low-stretch properties of the tension cord ensure that the pitch of the belt corresponds to the pitch of the pulley – even when under strain.

Teeth

The teeth are made of a shear and wear resistant rubber compound vulcanised to form a unit with the belt back. The shape and arrangement of the teeth are such that the pulley engages the belt teeth precisely and with minimum friction. As long as six teeth or more are in mesh on the small pulley, the complete capacity of the timing belt can be used without any deduction.

Fabric

In order to obtain a low level of wear on the running surfaces as well as achieving a high level of tooth shear strength, a tough, wear resistant fabric is applied to the outer tooth surface.

Tooth pitch, designations

optibelt ZR timing belts are manufactured according to ISO 5296, timing belt pulleys according to ISO 5294. Both come in six standard profiles.

Due to the American origin of the timing belt profile, the length unit is "in" for inch. The width/length codes have thus been derived from the imperial (inch) measurements of widths and lengths.

Table 1: Belt profiles and tooth pitch

Profile	Tooth pitch t	
	[mm]	[inches]
MXL	2.032	0.080 or $\frac{2}{25}$
XL	5.080	0.200 or $\frac{1}{5}$
L	9.525	0.375 or $\frac{3}{8}$
H	12.700	0.500 or $\frac{1}{2}$
XH	22.225	0.875 or $\frac{7}{8}$
XXH	31.750	1.250 or $1\frac{1}{4}$

Tooth pitch is the distance from the centre of one tooth to the centre of the next measured at the pitch line, which corresponds with the level of the tension cord. The pitch or datum diameter of the pulley is a theoretical dimension which lies outside the outer diameter.

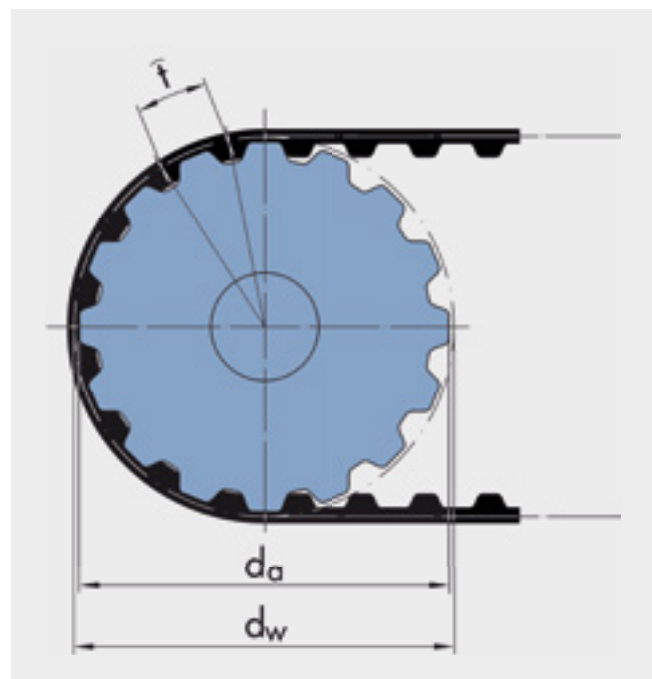

PRODUCT DESCRIPTION

optibelt ZR TIMING BELTS

ISO 5296



Nominal size

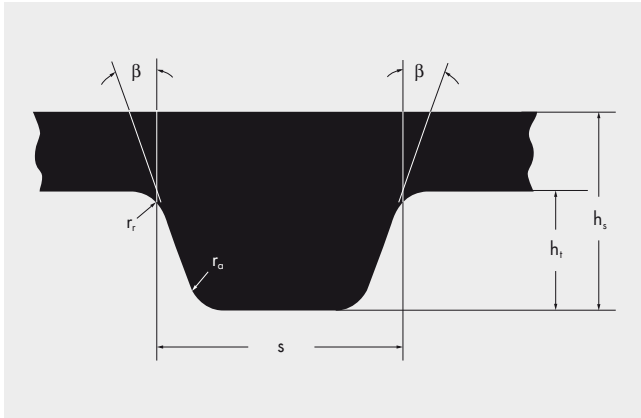

Table 2: Profile dimensions

Profile	MXL	XL	L	H	XH	XXH
Tooth angle 2β [°]	40	50	40	40	40	40
Tooth height h_t [mm]	0.51	1.27	1.91	2.29	6.35	9.53
Foot radius r_f [mm]	0.13	0.38	0.51	1.02	1.57	2.29
Head radius r_a [mm]	0.13	0.38	0.51	1.02	1.19	1.52
Tooth width s [mm]	1.14	2.57	4.65	6.12	12.57	19.05
Overall belt thickness h_s [mm]	1.2	2.3	3.6	4.0	11.2	15.7

Table 3: Width tolerances for optibelt ZR timing belts according to ISO 5296

Profile	Standard width		Allowed deviation of width for belt pitch lengths		
	Dimension [mm]	Width code	Up to 838.20 mm	Over 838.20 mm up to 1676.40 mm	Over 1676.40 mm
			[mm]	[mm]	[mm]
MXL	3.2	012	+ 0.5 - 0.8	-	-
	4.8	019			
	6.4	025			
XL	6.4	025	+ 0.5 - 0.8	+ 0.5 - 0.8	-
	7.9	031			
	9.5	037			
L	12.7	050	+ 0.8 - 0.8	+ 0.8 - 1.3	+ 0.8 - 1.2
	19.1	075			
	25.4	100			
H	19.1	075	+ 0.8 - 0.8	+ 0.8 - 1.3	+ 0.8 - 1.3
	25.4	100			
	38.1	150			
H	50.8	200	+ 0.8 - 1.3	+ 1.3 - 1.3	+ 1.3 - 1.5
	76.2	300			
XH	50.8	200	+ 4.8 - 4.8	+ 4.8 - 4.8	+ 4.8 - 4.8
	76.2	300			
	101.6	400			
XXH	50.8	200	+ 4.8 - 4.8	+ 4.8 - 4.8	+ 4.8 - 4.8
	76.2	300			
	101.6	400			
	127.0	500			

Weight per metre

Profile	MXL	XL	L	H	XH	XXH
kg/m per 1 mm width	0.0012	0,0021	0.0035	0.0041	0.0110	0.0147

PRODUCT DESCRIPTION

STANDARD PROPERTIES / SPECIAL DESIGNS



All optibelt ZR timing belts are oil-, heat- and cold-resistant as standard. Special labelling is not required.

Oil resistance

The inherent oil resistance prevents the damaging effects of mineral oils and greases, as long as these substances are not in permanent contact with the timing belt and/or are not present in large quantities. With increased demands for resistance, e.g. to mineral oils, the performance of the optibelt ZR timing belts can be improved by using special constructions. Please contact the optibelt Application Engineering Department for more details.

Temperature resistance

The timing belt can withstand ambient temperatures from $\approx -30^{\circ}\text{C}$ to $+100^{\circ}\text{C}$. Temperatures outside this range lead to premature ageing and embrittlement of the timing belts and thus to their premature failure. The temperature resistance of Optibelt ZR timing belts can be extended using special constructions, e.g. up to $+140^{\circ}\text{C}$. Please contact the OPTIBELT Application Engineering Department for more details.

Anti-static properties

Anti-static properties enable the safe discharge of electrostatic charges. This charging can have such a strong impact on timing belts with insufficient electrical conductivity that there is the danger of ignition due to sparks. The use of anti-static timing belts requires that the properties be checked in accordance with ISO 9563 and is confirmed by the issue of an inspection certificate.

optibelt ZR timing belts with angled sides

optibelt ZR timing belts with angled sides can be customised for special applications.

Special lengths, widths, tooth pitch or open-ended versions of optibelt ZR timing belts and the minimum order quantities are available on request.

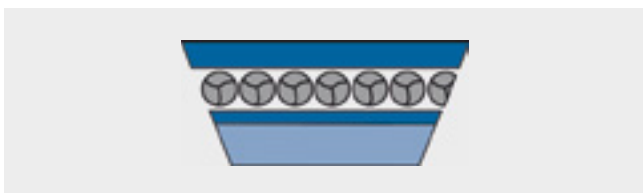

Possible combinations

optibelt ZR timing belts with standard or special compounds can be combined with other special designs. However, the individual properties of the special compounds cannot be combined with each other. For example, the properties of an extra heat-resistant belt cannot be combined with those of an antistatic belt.

Further special constructions

optibelt ZR timing belts with reinforced top surfaces

If the timing belt is to be used for the conveyance of various goods, we recommend using optibelt ZR timing belts with reinforced top surfaces.

Please give the required overall thickness (h_s) of the belt when ordering.

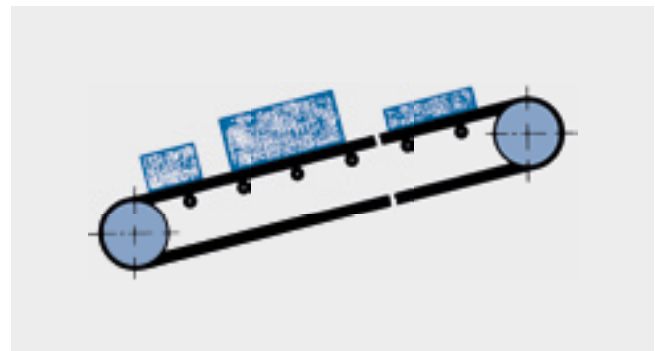

optibelt ZR timing belts with ground top surfaces

When using back bend idlers, especially when dealing with high belt speeds and vibration, we recommend optibelt ZR timing belts with ground top surfaces. Available grinding tolerances are given in the following table 4:

Table 4: optibelt ZR timing belts according to ISO 5296

Profile	Overall belt thickness h_s [mm]		
	Standard design	Quality class G 1	Quality class G 2
MXL	1.20 ± 0.25	1.20 ± 0.13 (≥ 80 MXL)	1.20 ± 0.25 (≥ 80 MXL)
XL	2.30 ± 0.25	2.30 ± 0.13	2.30 ± 0.25
L	3.60 ± 0.25	3.60 ± 0.13	3.60 ± 0.25
H	4.00 ± 0.25	4.00 ± 0.13	4.00 ± 0.25
XH	11.20 ± 0.65	—	11.20 ± 0.25
XXH	15.70 ± 0.65	—	15.70 ± 0.25

PRODUCT DESCRIPTION

optibelt OMEGA LINEAR AND optibelt ZR LINEAR



optibelt OMEGA HP LINEAR/ optibelt OMEGA LINEAR

optibelt OMEGA linear timing belts are open-ended timing belts with glass cord manufactured from sleeves in a spiral cut method.

- high level of tensile strength
- low stretch
- high positioning accuracy
- lower noise level than optibelt HTD®, optibelt ZR and polyurethane timing belts.
- maximum angle misalignment of 0.67° (depending on width)
- maintenance-free
- for medium and high loads
- based on ISO 13050
- standard roll length 30 m
- also available in profiles S5M and S8M

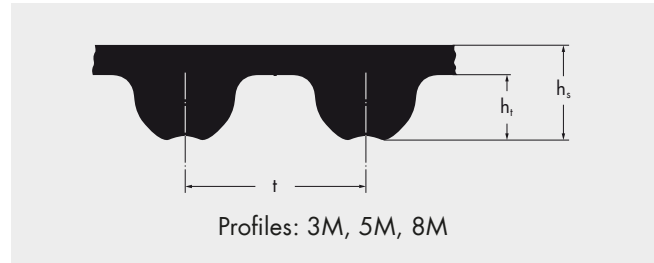

Standard product range; Profile, width

OMEGA 3M 9
OMEGA 5M 10, 5M 15, 5M 25
OMEGA 8M 10, 8M 15, 8M 20, 8M 25, 8M 30
OMEGA HP 3M 9
OMEGA HP 5M 10, 5M 15, 5M 25
OMEGA HP 8M 10, 8M 15, 8M 20, 8M 25, 8M 30

Special designs

- antistatic according to ISO 9563
- improved oil resistance
- extended temperature range

optibelt ZR LINEAR

optibelt ZR LINEAR timing belts with trapezoidal profile are manufactured from sleeves in a spiral cut method. These open-ended timing belts are reinforced with glass cord.

- high level of tensile strength
- maximum angle misalignment of 0.67° (depending on width)
- maintenance-free
- established worldwide
- for low levels of strain
- section standardised: ISO 5296/ISO 5294
- standard roll length: 30 m

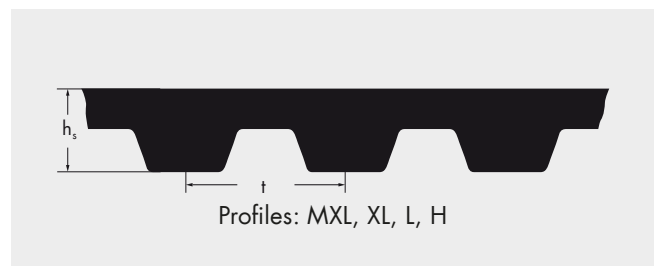

Standard product range; profile, width

MXL 025
XL 025, XL 037, XL 050
L 050, L 075, L 100
H 050, H 075, H 100

PRODUCT DESCRIPTION

optibelt ZR TIMING BELTS

ISO 5296

STANDARD PRODUCT RANGE



Profile	MXL	XL	L	H	XH	XXH
h_s [mm]	1.2	2.3	3.6	4.3	11.2	15.7
t [mm]	2.032	5.08	9.525	12.7	22.225	31.75

Profile MXL									Profile XL		
Belt designation	Pitch length [mm]	Number of teeth	Belt designation	Pitch length [mm]	Number of teeth	Belt designation	Pitch length [mm]	Number of teeth	Belt designation	Pitch length [mm]	Number of teeth
264 MXL•	67.06	33	808 MXL•	205.23	101	1320 MXL•	335.28	165	60 XL	152.40	30
360 MXL	91.44	45	816 MXL•	207.26	102	1360 MXL•	345.44	170	70 XL	177.80	35
432 MXL•	109.73	54	824 MXL•	209.30	103	1400 MXL	355.60	175	80 XL	203.20	40
440 MXL	111.76	55	840 MXL•	213.36	105	1440 MXL•	365.76	180	86 XL•	218.44	43
448 MXL•	113.79	56	848 MXL•	215.39	106	1472 MXL•	373.89	184	88 XL	223.52	44
456 MXL•	115.82	57	856 MXL•	217.42	107	1520 MXL•	386.08	190	90 XL	228.60	45
464 MXL•	117.86	58	864 MXL•	219.46	108	1560 MXL•	396.24	195	92 XL•	233.68	46
480 MXL	121.92	60	880 MXL	223.52	110	1600 MXL•	406.40	200	94 XL•	238.76	47
488 MXL•	123.95	61	896 MXL•	227.58	112	1768 MXL•	449.07	221	96 XL•	243.84	48
536 MXL•	136.14	67	904 MXL•	229.62	113	1800 MXL•	457.20	225	98 XL•	248.92	49
544 MXL•	138.18	68	912 MXL•	231.65	114	1888 MXL•	479.55	236	100 XL	254.00	50
560 MXL•	142.24	70	920 MXL•	233.68	115	1984 MXL•	503.94	248	102 XL	259.08	51
568 MXL•	144.27	71	960 MXL•	243.84	120	1992 MXL•	505.97	249	106 XL	269.24	53
576 MXL•	146.30	72	976 MXL•	247.90	122	2008 MXL•	510.03	251	108 XL•	274.32	54
600 MXL•	152.40	75	984 MXL•	249.94	123	2048 MXL•	520.19	256	110 XL	279.40	55
608 MXL•	154.43	76	1000 MXL•	254.00	125	2144 MXL•	544.58	268	112 XL•	284.48	56
632 MXL•	160.53	79	1008 MXL•	256.03	126	2240 MXL•	568.96	280	116 XL	294.64	58
640 MXL	162.56	80	1040 MXL•	264.16	130	2384 MXL•	605.54	298	118 XL•	299.72	59
656 MXL•	166.62	82	1056 MXL•	268.22	132	2480 MXL•	629.92	310	120 XL	304.80	60
664 MXL•	168.66	83	1072 MXL•	272.29	134	2520 MXL•	640.08	315	124 XL•	314.96	62
672 MXL•	170.69	84	1080 MXL•	274.32	135	2680 MXL•	680.72	335	126 XL	320.04	63
680 MXL•	172.72	85	1112 MXL•	282.45	139	2776 MXL•	705.10	347	128 XL	325.12	64
704 MXL•	178.82	88	1120 MXL	284.48	140	2880 MXL•	731.52	360	130 XL	330.20	65
720 MXL•	182.88	90	1136 MXL•	288.54	142	2920 MXL•	741.68	365	134 XL	340.36	67
728 MXL•	184.91	91	1176 MXL•	298.70	147	3200 MXL•	812.80	400	136 XL	345.44	68
736 MXL•	186.94	92	1184 MXL•	300.74	148	3472 MXL•	881.89	434	138 XL•	350.52	69
752 MXL•	191.01	94	1200 MXL•	304.80	150	3624 MXL•	920.50	453	140 XL	355.60	70
760 MXL•	193.04	95	1224 MXL•	310.90	153	3704 MXL•	940.82	463	142 XL	360.68	71
776 MXL•	197.10	97	1272 MXL•	323.09	159	3984 MXL•	1011.94	498	148 XL•	375.92	74
800 MXL•	203.20	100	1280 MXL•	325.12	160	4040 MXL•	1026.16	505	150 XL▲	381.00	75

The sizes marked ▲ are also available as double-sided timing belts.
Profiles and dimensions see page 34.

Standard width	Width code	Standard width	Width code
3.2 mm	012	6.4 mm	025
4.8 mm	019	7.9 mm	031
6.4 mm	025	9.5 mm	037
		12.7 mm	050
		19.1 mm	075
		25.4 mm	100

• Not available ex stock Further sizes on request

PRODUCT DESCRIPTION

optibelt ZR TIMING BELTS

ISO 5296

STANDARD PRODUCT RANGE



Profile	MXL	XL	L	H	XH	XXH
h_s [mm]	1.2	2.3	3.6	4.3	11.2	15.7
t [mm]	2.032	5.08	9.525	12.7	22.225	31.75

Profile XL						Profile L					
Belt designation	Pitch length [mm]	Number of teeth	Belt designation	Pitch length [mm]	Number of teeth	Belt designation	Pitch length [mm]	Number of teeth	Belt designation	Pitch length [mm]	Number of teeth
156 XL	396.24	78	286 XL•	726.44	143	109 L	276.23	29	439 L	1114.43	117
160 XL▲	406.40	80	290 XL	736.60	145	124 L	314.33	33	450 L▲	1143.00	120
162 XL•	411.48	81	296 XL•	751.84	148	150 L	381.00	40	454 L	1152.53	121
166 XL	421.64	83	300 XL▲	762.00	150	165 L	419.10	44	480 L▲	1219.20	128
168 XL•	426.72	84	306 XL•	777.24	153	169 L	428.63	45	510 L▲	1295.40	136
170 XL▲	431.80	85	310 XL▲	787.40	155	173 L	438.15	46	525 L	1333.50	140
174 XL•	441.96	87	316 XL	802.64	158	187 L▲	476.25	50	540 L▲	1371.60	144
176 XL	447.04	88	320 XL	812.80	160	202 L	514.35	54	600 L▲	1524.00	160
178 XL•	452.12	89	322 XL	817.88	161	210 L▲	533.40	56	630 L	1600.20	168
180 XL▲	457.20	90	330 XL	838.20	165	225 L▲	571.50	60	660 L	1676.40	176
182 XL	462.28	91	340 XL•	863.60	170	232 L	590.55	62	817 L	2075.18	218
184 XL•	467.36	92	344 XL•	873.76	172	236 L	600.08	63			
188 XL•	477.52	94	350 XL•	889.00	175	240 L▲	609.60	64			
190 XL▲	482.60	95	360 XL	914.40	180	255 L▲	647.70	68			
192 XL•	487.68	96	380 XL	965.20	190	259 L•	657.23	69			
194 XL	492.76	97	382 XL•	970.28	191	263 L•	666.75	70			
196 XL	497.84	98	388 XL•	985.52	194	270 L▲	685.80	72			
200 XL▲	508.00	100	390 XL	990.60	195	285 L▲	723.90	76			
210 XL▲	533.40	105	392 XL•	995.68	196	300 L▲	762.00	80			
220 XL▲	558.80	110	412 XL	1046.48	206	322 L▲	819.15	86			
230 XL▲	584.20	115	414 XL	1051.56	207	345 L▲	876.30	92			
240 XL▲	609.60	120	432 XL	1097.28	216	360 L	914.40	96			
244 XL•	619.76	122	434 XL	1102.36	217	367 L▲	933.45	98			
248 XL•	629.92	124	438 XL•	1112.52	219	375 L	952.50	100			
250 XL▲	635.00	125	460 XL	1168.40	230	390 L▲	990.60	104			
260 XL▲	660.40	130	498 XL•	1264.92	249	405 L	1028.70	108			
270 XL	685.80	135	506 XL•	1285.24	253	420 L▲	1066.80	112			
272 XL•	690.88	136	514 XL	1305.56	257	424 L•	1076.33	113			
274 XL•	695.96	137	580 XL•	1473.20	290	427 L•	1085.85	114			
280 XL▲	711.20	140	630 XL•	1600.20	315	435 L	1104.90	116			

The sizes marked ▲ are also available as double-sided timing belts.
Profiles and dimensions see page 34.

Standard width	Width code	Standard width	Width code
6.4 mm	025	12.7 mm	050
7.9 mm	031	19.1 mm	075
9.5 mm	037	25.4 mm	100
12.7 mm	050	38.1 mm	150
19.1 mm	075	50.8 mm	200
25.4 mm	100	76.2 mm	300

• Not available ex stock Further sizes on request

PRODUCT DESCRIPTION

optibelt **ZR** DOUBLE-SIDED TIMING BELTS

ISO 5296

STANDARD PRODUCT RANGE

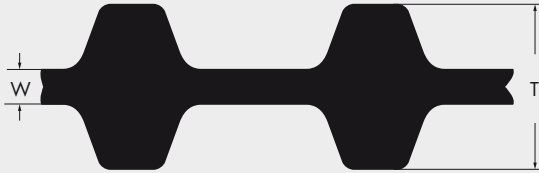

Profile s	DXL	DL	DH
W [mm]	0.508 ± 0.127	0.762 ± 0.127	1.372 ± 0.127
T [mm]	3.048 ± 0.178	4.572 ± 0.254	5.944 ± 0.127

Profile H						Profile XH			Profile XXH		
Belt designation	Pitch length [mm]	Number of teeth	Belt designation	Pitch length [mm]	Number of teeth	Belt designation	Pitch length [mm]	Number of teeth	Belt designation	Pitch length [mm]	Number of teeth
230 H	584.20	46	570 H▲	1447.80	114	507 XH	1289.05	58	700 XXH	1778.00	56
240 H▲	609.60	48	580 H	1473.20	116	560 XH	1422.40	64	800 XXH	2032.00	64
255 H	647.70	51	600 H▲	1524.00	120	630 XH	1600.20	72	900 XXH	2286.00	72
270 H▲	685.80	54	630 H▲	1600.20	126	700 XH	1778.00	80	1000 XXH	2540.00	80
280 H	711.20	56	650 H	1651.00	130	770 XH	1955.80	88	1200 XXH	3048.00	96
300 H▲	762.00	60	660 H▲	1676.40	132	840 XH	2133.60	96	1400 XXH	3556.00	112
310 H	787.40	62	670 H	1701.80	134	980 XH	2489.20	112	1600 XXH	4064.00	128
315 H	800.10	63	680 H	1727.20	136	1120 XH	2844.80	128	1800 XXH	4572.00	144
320 H	812.80	64	700 H▲	1778.00	140	1260 XH	3200.40	144			
330 H▲	838.20	66	720 H	1828.80	144	1400 XH	3556.00	160			
335 H	850.90	67	730 H	1854.20	146	1540 XH	3911.60	176			
340 H	863.60	68	750 H▲	1905.00	150	1750 XH	4445.00	200			
350 H	889.00	70	770 H	1955.80	154						
360 H▲	914.40	72	800 H▲	2032.00	160						
370 H	939.80	74	810 H	2057.40	162						
375 H	952.50	75	820 H	2082.80	164						
390 H▲	990.60	78	850 H▲	2159.00	170						
400 H	1016.00	80	860 H	2184.40	172						
410 H	1041.40	82	900 H▲	2286.00	180						
420 H▲	1066.80	84	950 H	2413.00	190						
430 H	1092.20	86	1000 H▲	2540.00	200						
450 H▲	1143.00	90	1100 H▲	2794.00	220						
465 H	1181.10	93	1120 H	2844.80	224						
480 H▲	1219.20	96	1140 H	2895.60	228						
490 H	1244.60	98	1150 H	2921.00	230						
510 H▲	1295.40	102	1250 H▲	3175.00	250						
520 H	1320.80	104	1400 H▲	3556.00	280						
530 H	1346.20	106	1700 H▲	4318.00	340						
540 H▲	1371.60	108									
560 H	1422.40	112									

The sizes marked ▲ are also available as double-sided timing belts.

Standard width	Width code	Standard width	Width code	Standard width	Width code
19.1 mm	075	50.8 mm	200	50.8 mm	200
25.4 mm	100	76.2 mm	300	76.2 mm	300
38.1 mm	150	101.6 mm	400	101.6 mm	400
50.8 mm	200	127.0 mm	500	127.0 mm	500
76.2 mm	300				

Further sizes on request.

DRIVE DESIGN

TIMING BELTS IN optibelt OMEGA PROFILE

EXPLANATION OF SYMBOLS



a	= Drive centre	[mm]	P	= Power to be transmitted by timing belt drive	[kW]
a_{nom}	= Drive centre distance with standard belt length	[mm]	P_B	= Design power	[kW]
c_0	= Basic load factor		P_N	= Rated power	[kW]
c_1	= Teeth in mesh factor		$P_{\ddot{U}}$	= Transmissible power for standard belt width [$P_N \cdot c_1 \cdot c_7$]	[kW]
c_2	= Overall load factor		S_a	= Minimum static shaft force when stationary	[N]
c_3	= Speed ratio correction factor		$S_{n\ zul}$	= Maximum allowed circumferential force	[N]
c_6	= Fatigue correction factor		S_{n3}	= Circumferential force to be effectively transmitted	[N]
c_7	= Belt length correction factor		S_n	= Effective circumferential force to be transmitted incl. actual centrifugal force	[N]
d_a	= Outside diameter of pulley	[mm]	t	= Tooth pitch	[mm]
d_w	= Pitch diameter of pulley	[mm]	v	= Belt speed	[m/s]
d_{wg}	= Pitch diameter of large pulley	[mm]	x	= Minimum adjustment of drive centre distance a_{nom} for tensioning timing belt	[mm]
d_{wk}	= Pitch diameter of small pulley	[mm]	y	= Minimum adjustment of drive centre distance a_{nom} for installation	[mm]
d_{w1}	= Pitch diameter of driving pulley	[mm]	z_e	= Number of teeth in mesh of small pulley	
d_{w2}	= Pitch diameter of driven pulley	[mm]	z_g	= Number of teeth on large pulley	
E_a	= Belt deflection for given span length	[mm]	z_k	= Number of teeth on small pulley	
F	= Force to create deflection	[N]	z_r	= Number of teeth on timing belt	
f	= Frequency	[Hz]	z_1	= Number of teeth on driving pulley	
i	= Speed ratio		z_2	= Number of teeth on driven pulley	
L	= Drive span length	[mm]			
L_{wSt}	= Standard pitch length of timing belt	[mm]			
L_{wth}	= Calculated pitch length of timing belt	[mm]			
n_1	= Speed of driving pulley	[min ⁻¹]			
n_2	= Speed of driven pulley	[min ⁻¹]			

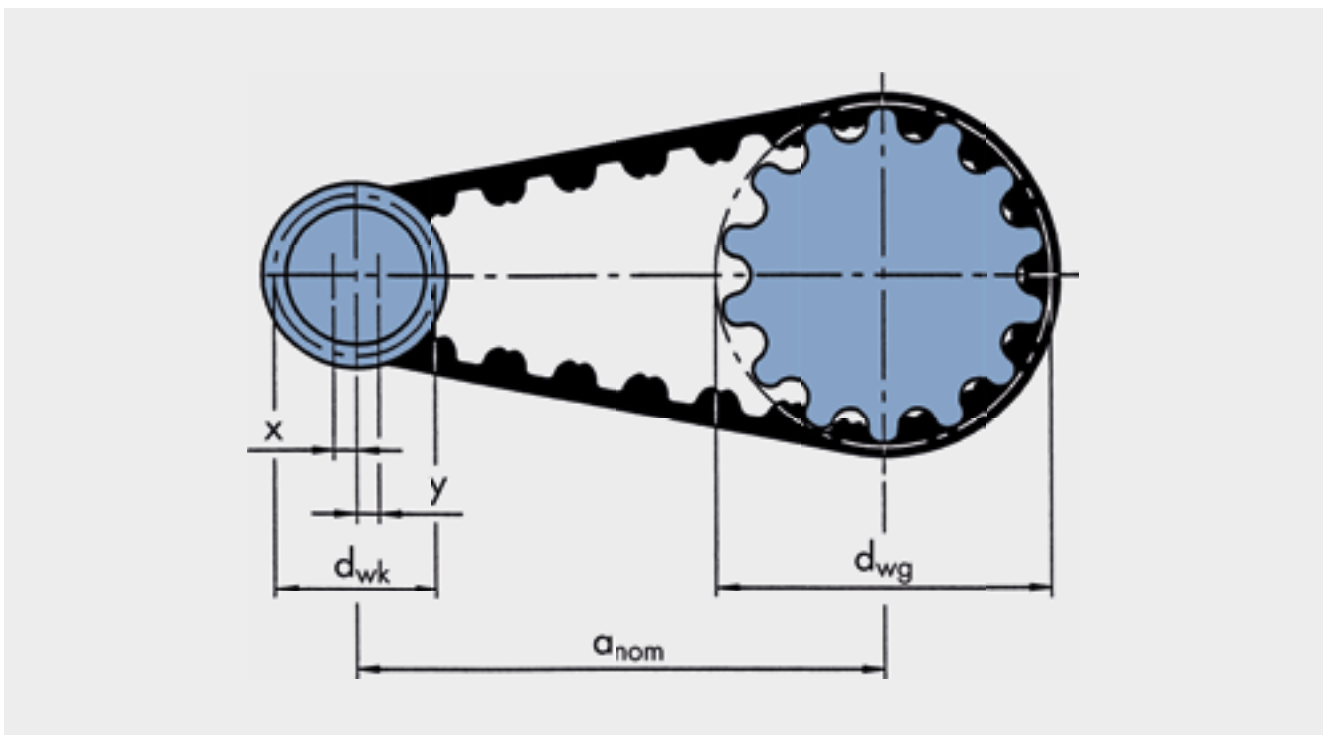

DRIVE DESIGN

optibelt **OMEGA HL** TIMING BELTS

GUIDELINES FOR SELECTING THE TIMING BELT PROFILE



Diagram 1

Also see
optibelt CAP drive calculation
software at www.optibelt.com

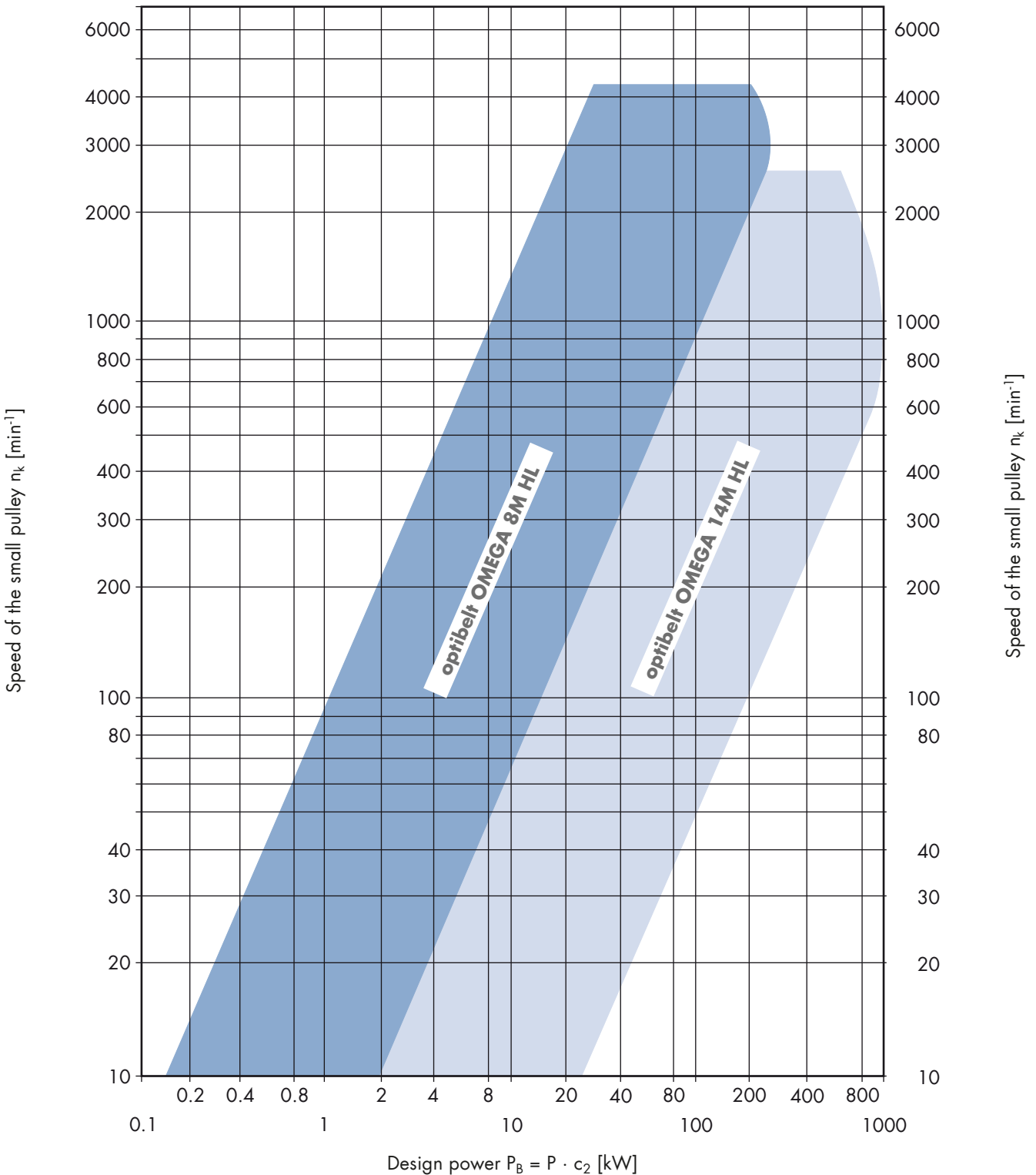

DRIVE DESIGN

optibelt OMEGA HP, optibelt OMEGA FAN POWER TIMING BELTS GUIDELINES FOR SELECTING THE TIMING BELT PROFILE



Diagram 2

Also see
optibelt CAP drive calculation
software at www.optibelt.com

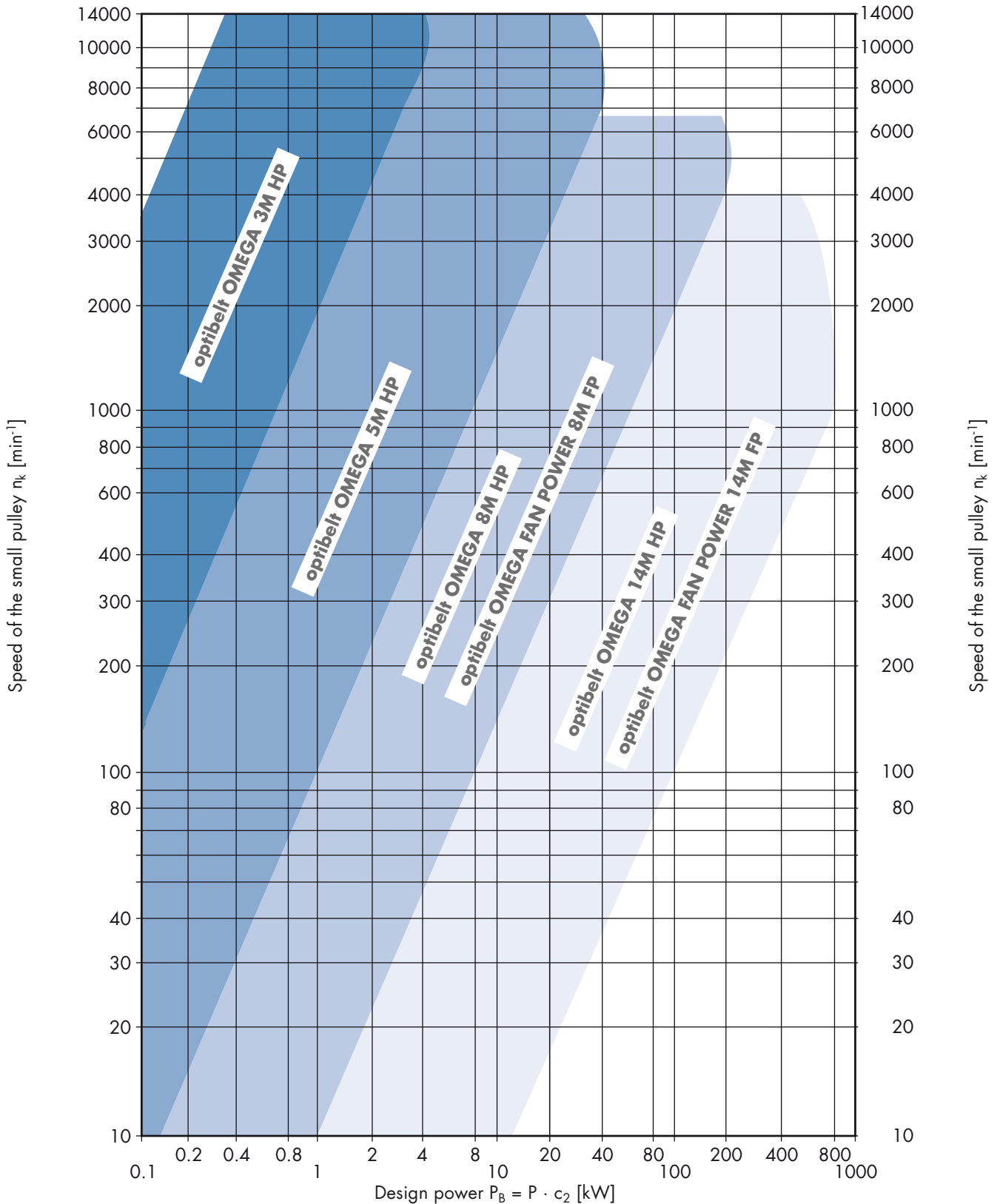

DRIVE DESIGN

optibelt **OMEGA** TIMING BELTS

GUIDELINES FOR SELECTING THE TIMING BELT PROFILE



Diagram 3

Also see
optibelt CAP drive calculation
software at www.optibelt.com

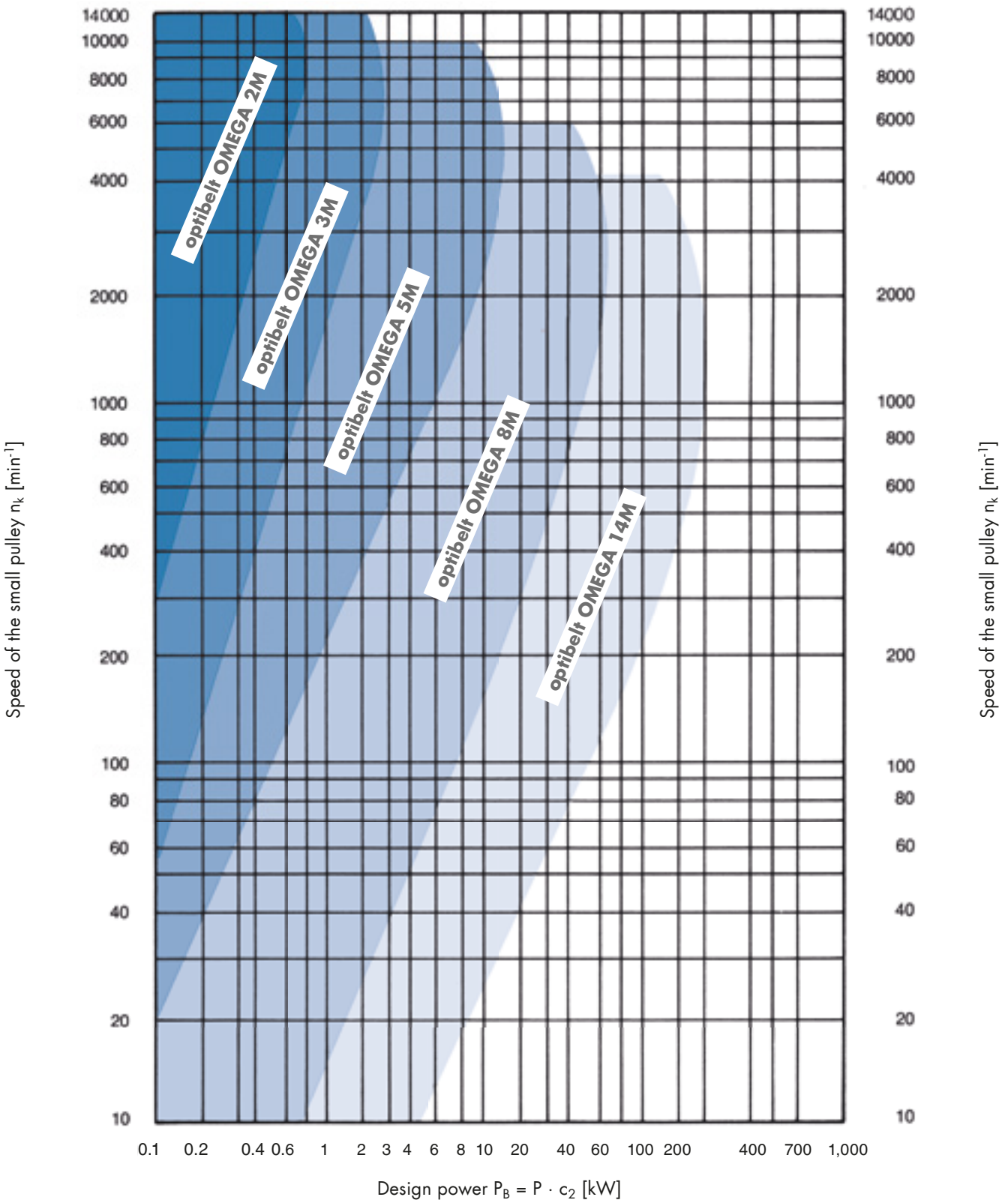

DRIVE DESIGN

optibelt ZR TIMING BELTS

GUIDELINES FOR SELECTING THE TIMING BELT PROFILE



Diagram 4

Please also use software:
optibelt CAP drive calculation
and data optibelt CAD 2D / 3D
online at: www.optibelt.com

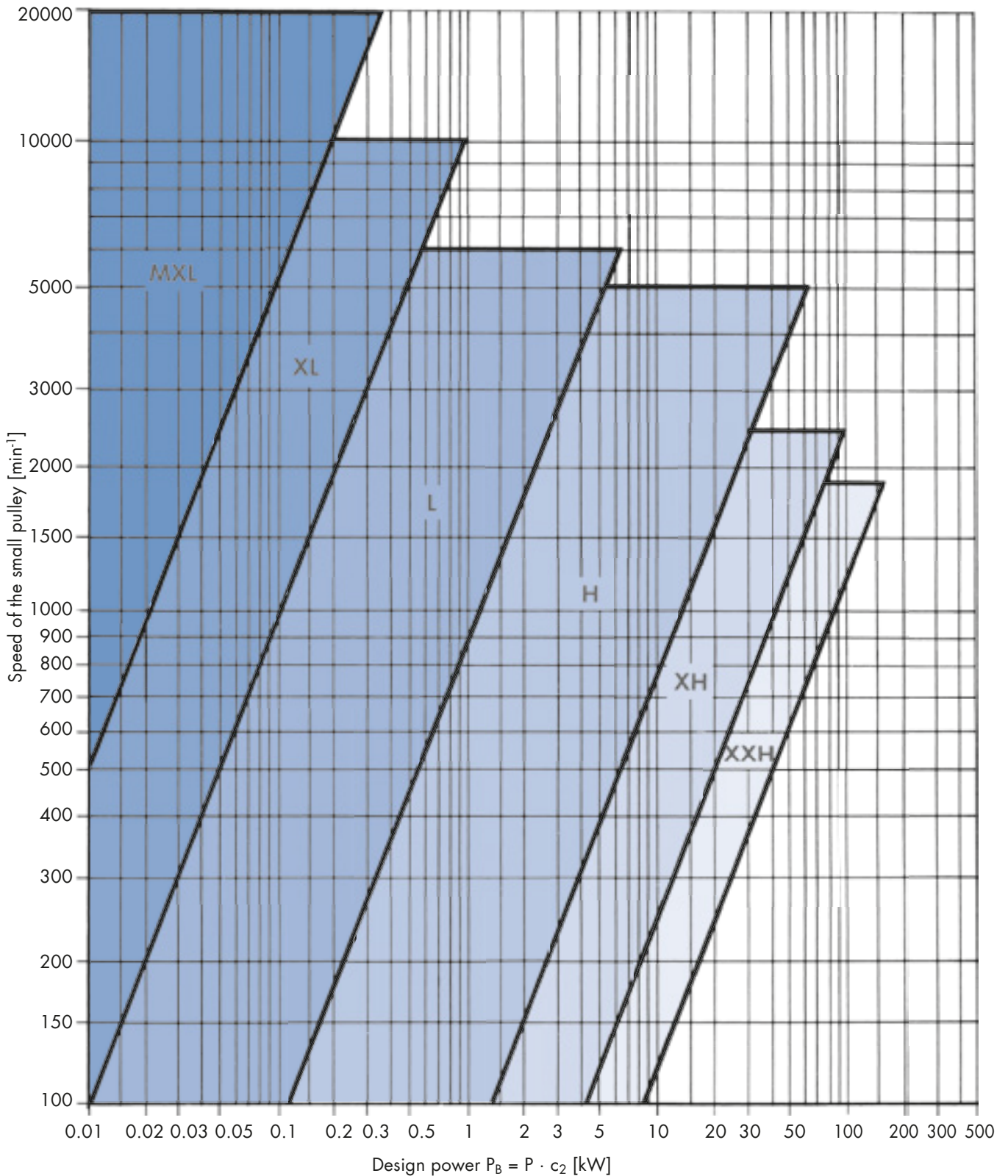

DRIVE DESIGN

TIMING BELTS IN optibelt OMEGA PROFILE

LOAD FACTORS



Total load factor c_2

The total load factor c_2 is comprised of the basic load factor c_0 plus two further loads c_3 and c_6 .

$$c_2 = c_0 + c_3 + c_6$$

$$c_2 \geq M_A/M_N \quad \text{recommended for frequent starts and stops}$$

Basic load factor c_0

The basic load factor c_0 takes into account the daily operating time, the type of drive and the prime mover. As it is almost impossible to put all the possible combinations of prime mover / driven unit / environmental conditions in a shortened form which conforms to standards, the service factors shown here are given only as a guideline. The classification of the work machine is dependent on the respective present load type.

Table 5
Basic load factor c_0

Load type and examples for work machines	Load type and examples for drive machines			
	Continuous running		Non-continuous running	
	Electric motor Turbine running at high speed Reciprocating engine with higher quantity of cylinders		Hydraulic motor Turbine running at low speed Reciprocating engine with lower quantity of cylinders	
Basic load factor c_0 with daily operation times				
	up to 16 h	up to 16 h	up to 16 h	over 16 h
Light drives. shock-free with smooth running characteristics Measurement devices Film cameras Office machines Conveyor systems (light goods)	1.3	1.4	1.4	1.5
Medium drives. operation with smaller to medium intermittent shock strain Mixing machines Kitchen machines Printing shop machines Textile machines Packaging machines Conveyor systems (heavy goods)	1.6	1.7	1.8	1.9
Heavy drives. operation with medium to high intermittent shock strain Tool machines Wood processing machines Eccentric drives Conveyor systems (heavy goods)	1.8	1.9	2.0	2.1
Extremely heavy drives. operation with high constant shock strain Mills Calendars Extruders Piston pumps/compressors Lifting appliances	2.0	2.1	2.2	2.3

DRIVE DESIGN

TIMING BELTS IN optibelt OMEGA PROFILE

ADDITIONAL FACTORS



Speed correction factor c_3

For speed increasing drives, a factor corresponding to the speed ratio is added to the basic load factor c_0 .

Table 6

Speed correction i	Speed correction factor c_3
1.00–0.80	0.0
0.79–0.57	0.1
0.56–0.40	0.2
0.39–0.28	0.3
0.27 and smaller	0.4

Table 7

Fatigue correction factor c_6

Operating conditions	Fatigue correction factor c_6
Use of tension or guide idlers	0.2
Operating time 16 to 24 hours	0.2
Only infrequent or occasional operation	-0.2

With frequent starts and stops or continual reversing operation, the selected total load factor c_2 should be higher than the ratio between starting torque and nominal torque. If there is a brake on the prime mover the same procedure should apply for the braking torque, if the brake is used frequently. For further questions, please contact the OPTIBELT Application Engineering Department.

Minimum adjustment of centre distance 'x' for tensioning of timing belts

$$x = 0.004 \cdot a_{nom}$$

Table 8

Minimum adjustment of centre distance 'y' for installation on timing belt pulleys without flanges

Axial distance [mm]	Shifting distance for the installation of the belt [mm]
Up to 1000	1.8
From 1000 to 1780	2.8
From 1780 to 2540	3.3
From 2540 to 3300	4.1
From 3300 to 4600	5.3

Table 9

Minimum adjustment of centre distance 'y' for installation on timing belt pulleys with flanges

Pitch [mm]	Flange on one timing pulley [mm]	Flange on both timing pulleys [mm]
2	6	12
3	8	14
5	14	19
8	22	33
14	36	58

Table 10

Belt length factor c_7

Profile 2M		Profile 8M	
Pitch length [mm]	c_7	Pitch length [mm]	c_7
≤ 190	0.8	≤ 600	0.8
$> 190 \leq 260$	0.9	$> 600 \leq 880$	0.9
$> 260 \leq 400$	1.0	$> 880 \leq 1200$	1.0
$> 400 \leq 600$	1.1	$> 1200 \leq 1760$	1.1
> 600	1.2	> 1760	1.2
Profile 3M		Profile 14M	
Pitch length [mm]	c_7	Pitch length [mm]	c_7
≤ 190	0.8	≤ 1190	0.80
$> 190 \leq 260$	0.9	$> 1190 \leq 1610$	0.90
$> 260 \leq 400$	1.0	$> 1610 \leq 1890$	0.95
$> 400 \leq 600$	1.1	$> 1890 \leq 2450$	1.00
> 600	1.2	$> 2450 \leq 3150$	1.05
Profile 5M		> 3150	1.10
Pitch length [mm]	c_7		
≤ 440	0.8		
$> 440 \leq 555$	0.9		
$> 555 \leq 800$	1.0		
$> 800 \leq 1100$	1.1		
> 1100	1.2		

Table 11

Teeth in mesh factor c_1

Number of meshing teeth	Teeth in mesh factor c_1
≥ 6	1.0
5	0.8
4	0.6
3	0.4
2	0.2

DRIVE DESIGN

TIMING BELTS IN optibelt OMEGA PROFILE

FORMULAS AND CALCULATION EXAMPLES



Prime mover

Electric motor 50 Hz
 Star delta start
 $P = 18.5 \text{ kW}$
 $n_1 = 2850 \text{ min}^{-1}$

Operating conditions

Daily operating time: 12 hours
 Number of starts/stops: 2 per day
 Environmental influences:
 ambient room temperature,
 no influence from oil, water or dust
 Centre distance: 400 mm to 450 mm
 Max. pulley diameter: 200 mm

Driven machine

Textile machine
 $P = 15 \text{ kW}$
 $n_2 = 1830 \text{ min}^{-1} \pm 1\%$
 Type of load: constant

Also see
 optibelt CAP drive calculation
 software at www.optibelt.com

Formulae

Total load factor

$c_2 = c_0 + c_3 + c_6$
 c_0 from table 5, page 40
 c_3 from table 6, page 41
 c_6 from table 7, page 42

Design power

$$P_B = P \cdot c_2$$

Timing belt profile

from diagrams 1-4, pages 36-39

Speed ratio

$$i = \frac{n_1}{n_2} = \frac{z_2}{z_1} = \frac{d_{w2}}{d_{w1}}$$

Number of teeth of the pulleys

z_1, d_{w1} selected from standard range of timing belt pulleys page 75

$$z_2 = z_1 \cdot i$$

See to the minimum diameter requirement!

Check the rotary frequency

$$i = \frac{z_2}{z_1}$$

$$n_2 = \frac{n_1}{i}$$

Recommended centre distance

Recommendation:

$$a > 0.5 (d_{w1} + d_{w2}) + 15 \text{ mm}$$

$$a < 2.0 (d_{w1} + d_{w2})$$

Worked example

$$c_2 = 1.6 + 0 + 0 = \mathbf{1.6}$$

$$c_0 = 1.6$$

$$c_3 = 0$$

$$c_6 = 0$$

$$P_B = 18.5 \cdot 1.6 = \mathbf{29.6 \text{ kW}}$$

optibelt OMEGA HP

Type 8M

$$i = \frac{2850}{1830} = \mathbf{1.557}$$

$$z_1 = \mathbf{36}$$

$$d_{w1} = 91.67 \text{ mm}$$

$$z_2 = 36 \cdot 1.56 = 56.16$$

$$z_2 = \mathbf{56}$$

$$d_{w2} = 142.60 \text{ mm}$$

z_2 selected from standard range pulleys page 75

In compliance with requirement $z_1 \geq 22$ (minimum number of teeth for profile 8M)

$$i = \frac{56}{36} = 1.556$$

$$n_2 = \frac{2850}{1.556} = \mathbf{1832 \text{ min}^{-1}}$$

Requirement:
 $\mathbf{1830 \text{ min}^{-1} \pm 1\% \text{ met}}$

$$a > 0.5 (91.67 + 142.60) + 15 \text{ mm} = 132.14 \text{ mm}$$

$$a < 2.0 (91.67 + 142.60) = 468.54 \text{ mm}$$

$a = \mathbf{425 \text{ mm}}$ provisionally selected

DRIVE DESIGN

TIMING BELTS IN optibelt OMEGA PROFILE

FORMULAS AND CALCULATION EXAMPLES



Formulas

Pitch length of the timing belt

$$L_{\text{with}} \approx 2a + \frac{\pi}{2} (d_{\text{wg}} + d_{\text{wk}}) + \frac{(d_{\text{wg}} - d_{\text{wk}})^2}{4a}$$

L_{wSt} see standard lengths,
see pages 10-11, 13, 16-19, 21-27, and 32-34

Centre distance from L_{wSt}

$$a_{\text{nom}} = K + \sqrt{K^2 - \frac{(d_{\text{wg}} - d_{\text{wk}})^2}{8}}$$

$$K = \frac{(L_{\text{wSt}})}{4} - \frac{\pi}{8} (d_{\text{wg}} + d_{\text{wk}})$$

Minimum adjustment for tensioning

$$x = 0.004 \cdot a_{\text{nom}}$$

Minimum adjustment for fitting belts

y = from table 9, page 41

Number of teeth in mesh on the small pulley

$$z_e = \frac{z_k}{6} \left(3 - \frac{d_{\text{wg}} - d_{\text{wk}}}{a_{\text{nom}}} \right)$$

Belt length factor

c_7 from table 10, page 41

Teeth in mesh factor

c_1 from table 11, page 41

Belt width above nominal power rating

Requirement: $P_{\text{Ü}} \geq P_{\text{B}}$

$P_{\text{Ü}}$ = transmissible nominal power of a standard belt width

$$P_{\text{Ü}} = P_{\text{N}} \cdot c_1 \cdot c_7$$

P_{N} value and, if required, width correction factor (which is to be multiplied by the P_{N} value) see pages 46 to 58

Worked example

$$L_{\text{with}} \approx 2 \cdot 425 + \frac{\pi}{2} (142.60 + 91.67) + \frac{(142.60 - 91.67)^2}{4 \cdot 425}$$

$$L_{\text{with}} \approx \mathbf{1219.33 \text{ mm}}$$

next standard belt length selected from page 18

$$L_{\text{wSt}} = \mathbf{1200 \text{ mm}}$$

$$a_{\text{nom}} = 208 + \sqrt{208^2 - \frac{(142.60 - 91.67)^2}{8}}$$

$$a_{\text{nom}} = \mathbf{415.22 \text{ mm}}$$

$$K = \frac{1200}{4} - \frac{\pi}{8} (142.60 + 91.67) = 208 \text{ mm}$$

$$x \geq \mathbf{1.66 \text{ mm}}$$

$$y = \mathbf{22 \text{ mm}}$$
 (with flanged pulley)

$$z_e = \frac{36}{6} \left(3 - \frac{142.60 - 91.67}{415} \right) = 17.26$$

$$z_e = \mathbf{17}$$

$$c_7 = \mathbf{1.0}$$

$$c_1 = \mathbf{1.0}$$

31.09 kW > 29.60 kW Requirement met!

$$P_{\text{Ü}} = 31.09 \cdot 1.0 \cdot 1.0 = \mathbf{31.09 \text{ kW}}$$

$$P_{\text{N}} \text{ for width of 30 mm} = 19.68 \cdot 1.58 = \mathbf{31.09 \text{ kW}}$$

Drive to be fitted with:

1 optibelt OMEGA HP timing belt	1200 8M HP	30
1 optibelt ZRS timing belt pulley	36 8M	30
1 optibelt ZRS timing belt pulley	56 8M	30

DRIVE DESIGN

TIMING BELTS IN optibelt OMEGA PROFILE

BELT TENSION



Belt tension for optibelt OMEGA HP/optibelt OMEGA HL and optibelt OMEGA timing belts

For proper power transmission and for achieving an acceptable belt service life, the correct belt tension is of the utmost importance.

Too low or too high belt tension will lead to the premature failure of the timing belts. Over tensioning often leads to bearing failure on the prime mover or the driven machine. Experience shows that unscientific belt tensioning methods, such as the "thumb pressure method", are not suitable for applying the optimum tension to the drive for maximum efficiency and drive/bearing life. It is therefore recommended that the correct static belt tension should be calculated for each drive. Due to their extremely low-stretch characteristics OPTIBELT timing belts do not require any further tensioning after correct installation, if properly used.

Symbol

F	= test force	[N]
S _α	= static shaft loading	[N]
S _{n3}	= circumferential force to be effectively transmitted	[N]
E _α	= belt deflection for given span length	[mm]
L	= span length	[mm]

Apply test force F in the centre of the span in a right angle to the belt top surface as shown in the illustration below; measure the deflection E_α, correct the tension if necessary.

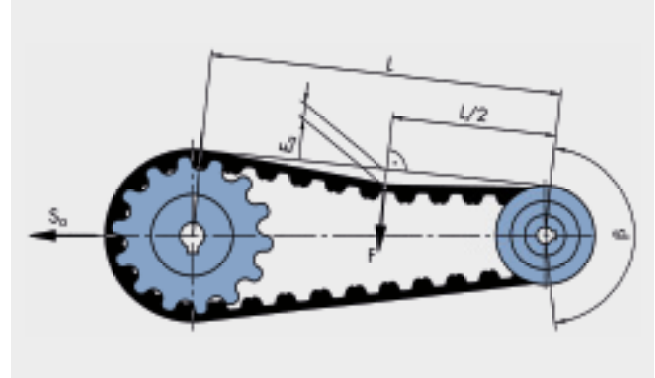

1. Calculation of the test force F

$$F = \frac{S_{n3}}{20}$$

$$S_{n3} = \frac{P \cdot 1000}{v}$$

$$v = \frac{d_{wk} \cdot n_k}{19100}$$

$$F = \frac{1352}{20} = \mathbf{67.60 \text{ N}}$$

$$S_{n3} = \frac{18.5 \cdot 1000}{13.68}$$

$$v = \frac{91.67 \cdot 2850}{19100}$$

$$S_{n3} = 1352 \text{ N}$$

$$v = 13.68 \text{ m/s}$$

2. Calculation of the belt deflection E_α for the existing span length L

$$E_{\alpha} = \frac{L}{50}$$

$$L = \sqrt{\alpha_{nom}^2 - \left(\frac{d_{wg} - d_{wk}}{2}\right)^2}$$

$$E_{\alpha} = \frac{414.44}{50} = \mathbf{8.3 \text{ mm}}$$

$$L = \sqrt{415.22^2 - \left(\frac{142.60 - 91.67}{2}\right)^2} = 414.44 \text{ mm}$$

3. Calculation of the minimum static shaft loading

$$S_{\alpha} = S_{n3} \cdot 1.1$$

$$S_{\alpha} = 1352 \text{ N} \cdot 1.1 = \mathbf{1487.2 \text{ N}}$$

4. Calculation of the frequency for measuring the belt tension using the OPTIBELT frequency tension tester

$$f = \sqrt{\frac{T}{4 \cdot k \cdot L^2}}$$

$$T = 0.5 \cdot S_{\alpha}$$

k belt weight per metre from table 37, page 72

L span length per metre

$$f = \sqrt{\frac{743.6}{4 \cdot 0.174 \cdot 0.414^2}} = \mathbf{78.9 \text{ Hz}}$$

$$T = 0.5 \cdot 1487.2 \text{ N} = 743.6 \text{ N}$$

k = 0.174 kg/m

L = 0.414 m

POWER RATINGS

optibelt **OMEGA HL** TIMING BELTS

PROFILE AND DESIGN 8M HL



Table 12

Nominal power P_N [kW] for profile and design 8M HL and a timing belt width of 20 mm																	
Speed of the small pulley n_k [min ⁻¹]	Number of teeth on the small pulley z_k																
	22	24	26	28	30	32	34	36	38	40	44	48	52	56	64	72	80
	Pitch diameter of the small pulley d_{wk} [mm]																
	56.02	61.12	66.21	71.30	76.39	81.49	86.58	91.67	96.77	101.86	112.05	122.23	132.42	142.60	162.97	183.35	203.72
10	0.07	0.08	0.09	0.09	0.11	0.12	0.13	0.14	0.15	0.15	0.18	0.20	0.22	0.24	0.27	0.31	0.34
20	0.13	0.15	0.18	0.19	0.21	0.22	0.25	0.27	0.28	0.31	0.34	0.38	0.41	0.45	0.53	0.60	0.67
50	0.32	0.35	0.40	0.45	0.49	0.54	0.59	0.64	0.67	0.72	0.81	0.90	0.98	1.07	1.25	1.43	1.59
100	0.59	0.68	0.77	0.86	0.94	1.04	1.12	1.20	1.30	1.38	1.56	1.72	1.89	2.06	2.39	2.73	3.06
200	1.12	1.30	1.46	1.63	1.80	1.97	2.13	2.30	2.47	2.64	2.97	3.30	3.62	3.95	4.59	5.24	5.89
300	1.63	1.87	2.12	2.37	2.62	2.86	3.11	3.36	3.61	3.84	4.34	4.82	5.30	5.77	6.73	7.67	8.61
400	2.11	2.44	2.76	3.09	3.42	3.73	4.06	4.38	4.70	5.02	5.67	6.29	6.92	7.55	8.80	10.05	11.28
500	2.58	2.98	3.39	3.79	4.19	4.59	5.00	5.40	5.78	6.19	6.96	7.75	8.53	9.31	10.85	12.37	13.89
600	3.04	3.52	4.01	4.49	4.96	5.43	5.91	6.39	6.86	7.32	8.26	9.19	10.11	11.03	12.85	14.67	16.47
700	3.58	4.16	4.72	5.30	5.87	6.43	6.99	7.55	8.11	8.67	9.78	10.87	11.97	13.07	15.23	17.39	19.52
800	3.95	4.57	5.21	5.83	6.46	7.08	7.71	8.32	8.94	9.55	10.78	11.99	13.20	14.41	16.80	19.17	21.53
1000	4.82	5.60	6.37	7.15	7.93	8.69	9.46	10.23	10.98	11.75	13.25	14.75	16.24	17.72	20.67	23.58	26.46
1200	5.68	6.60	7.53	8.45	9.37	10.27	11.18	12.09	13.00	13.89	15.68	17.45	19.21	20.97	24.45	27.90	31.30
1450	6.76	7.88	8.99	10.10	11.19	12.29	13.38	14.47	15.55	16.62	18.77	20.90	23.01	25.12	29.28	33.39	37.44
1600	7.34	8.55	9.77	10.97	12.17	13.36	14.55	15.73	16.91	18.08	20.42	22.73	25.02	27.31	31.83	36.29	40.69
1800	8.15	9.51	10.86	12.21	13.54	14.87	16.20	17.52	18.83	20.14	22.74	25.32	27.86	30.41	35.43	40.38	45.24
2000	8.94	10.45	11.93	13.42	14.89	16.36	17.83	19.27	20.72	22.16	25.02	27.86	30.66	33.46	38.97	44.38	49.70
2200	9.73	11.37	13.00	14.62	16.22	17.83	19.42	21.01	22.59	24.15	27.27	30.36	33.40	36.44	42.42	48.27	54.00
2400	10.51	12.29	14.06	15.81	17.55	19.29	21.02	22.74	24.45	26.14	29.51	32.85	36.13	39.42	45.87	52.16	58.31
2800	12.04	14.09	16.13	18.14	20.16	22.15	24.14	26.11	28.08	30.02	33.88	37.70	41.45	45.19	52.50	59.60	66.50
3000	12.49	14.62	16.73	18.84	20.92	23.00	25.06	27.11	29.15	31.16	35.18	39.13	43.01	46.89	54.44	61.77	68.86
3500	14.63	17.14	19.64	22.11	24.56	27.00	29.43	31.83	34.21	36.58	41.26	45.87	50.35	54.83	63.48		
4000	16.42	19.25	22.07	24.86	27.63	30.36	33.08	35.78	38.44	41.09	46.30	51.43	56.38	61.34			
4500	18.17	21.31	24.44	27.53	30.60	33.63	36.63	39.60	42.53	45.44	51.16	56.74	62.31				
5000	19.86	23.32	26.74	30.13	33.48	36.79	40.06	43.30	46.49	49.64	55.81	61.81	68.14				
5500	21.51	25.27	28.98	32.66	36.28	39.86	43.38	46.86	50.28	53.67	60.25						

Power ratings for other belt widths can be calculated by multiplying by the width correction factors.

Width correction factor				
Profile and design 8M HL				
Standard belt width [mm]	20	30	50	85
Factor	1.00	1.58	2.73	4.76

POWER RATINGS

optibelt **OMEGA HL** TIMING BELTS

PROFILE AND DESIGN 14M HL



Table 13

Nominal power P_N [kW] for profile and design 14M HL and a timing belt width of 40 mm																	
Speed of the small pulley n_k [min ⁻¹]	Number of teeth on the small pulley z_k																
	28	29	30	32	34	36	38	40	42	44	46	48	52	56	64	72	80
	Pitch diameter of the small pulley d_{wk} [mm]																
	124.78	129.23	133.69	142.60	151.52	160.43	169.34	178.25	187.17	196.08	204.99	213.90	231.73	249.55	285.21	320.86	356.51
10	0.53	0.56	0.59	0.62	0.67	0.72	0.77	0.80	0.85	0.90	0.94	0.99	1.07	1.15	1.32	1.50	1.66
20	1.01	1.05	1.08	1.18	1.27	1.34	1.44	1.52	1.60	1.68	1.77	1.85	2.01	2.18	2.50	2.83	3.13
40	1.87	1.94	2.02	2.19	2.34	2.50	2.66	2.82	2.97	3.13	3.28	3.43	3.74	4.05	4.65	5.25	5.84
60	2.72	2.84	2.96	3.19	3.42	3.65	3.89	4.11	4.34	4.57	4.80	5.02	5.47	5.91	6.81	7.67	8.54
100	4.29	4.48	4.67	5.04	5.42	5.78	6.14	6.52	6.88	7.25	7.60	7.95	8.67	9.38	10.78	12.17	13.55
200	7.94	8.29	8.65	9.34	10.05	10.73	11.42	12.10	12.78	13.47	14.13	14.80	16.14	17.47	20.09	22.67	25.22
300	11.35	11.85	12.35	13.36	14.37	15.36	16.35	17.34	18.32	19.30	20.26	21.23	23.14	25.05	28.81	32.52	36.18
400	14.59	15.25	15.91	17.20	18.50	19.79	21.08	22.34	23.60	24.87	26.12	27.37	29.84	32.31	37.16	41.94	46.64
500	17.71	18.51	19.31	20.90	22.49	24.06	25.63	27.18	28.71	30.24	31.77	33.30	36.30	39.30	45.21	51.01	56.73
600	20.72	21.67	22.62	24.49	26.34	28.21	30.04	31.86	33.67	35.49	37.27	39.04	42.57	46.10	53.01	59.79	66.47
700	24.25	25.35	26.46	28.66	30.86	33.04	35.19	37.32	39.45	41.58	43.67	45.76	49.88	54.01	62.09	70.00	77.77
800	26.54	27.76	28.98	31.39	33.79	36.17	38.54	40.89	43.22	45.54	47.83	50.13	54.64	59.14	67.98	76.62	85.09
950	32.11	33.59	35.07	38.00	40.92	43.80	46.68	49.52	52.34	55.16	57.93	60.70	66.14	71.59	82.20	92.53	102.61
1000	37.45	39.19	40.93	44.36	47.77	51.16	54.51	57.82	61.11	64.40	67.63	70.86	77.17	83.49	95.74	107.59	119.09
1200	44.15	46.20	48.25	52.32	56.34	60.33	64.27	68.18	72.04	75.90	79.67	83.45	90.80	98.15	112.33	125.91	138.93
1450	47.63	49.85	52.06	56.46	60.79	65.09	69.35	73.57	77.71	81.86	85.91	89.97	97.84	105.72	120.79	135.16	148.83
1600	52.48	54.93	57.38	62.21	67.00	71.72	76.40	81.01	85.55	90.10	94.52	98.95	107.51	116.06	132.29	147.61	
1800	57.19	59.86	62.54	67.79	73.00	78.14	83.20	88.21	93.12	98.02	102.80	107.57	116.72	125.86	143.08		
2000	61.70	64.57	67.45	73.12	78.72	84.23	89.66	95.01	100.24	105.47	110.54	115.60	125.24	134.87			
2200	66.20	69.28	72.36	78.44	84.44	90.32	96.12	101.82	107.37	112.92	118.28	123.64	133.76	143.88			
2400	70.44	73.72	76.99	83.43	89.77	95.98	102.09	108.09	113.90	119.71	125.30	130.88					
2600	74.68	78.15	81.62	88.42	95.10	101.64	108.07	114.35	120.43	126.51	132.31	138.12					
2850	77.12	80.70	84.27	91.28	98.15	104.88	111.47	117.90	124.11	130.33	136.23	142.14					
3000	88.30	92.35	96.39	104.27	111.94	119.38	126.62	133.63									
3500	97.06	101.43	105.80	114.27	122.45												

Power ratings for other belt widths can be calculated by multiplying by the width correction factors.

Width correction factor					
Profile and design 14M HL					
Standard belt width [mm]	40	55	85	115	170
Factor	1.00	1.44	2.50	3.50	5.32

POWER RATINGS

optibelt OMEGA FAN POWER TIMING BELTS

PROFILE AND DESIGN 8M FP



Table 14

Nominal power P_N [kW] for profile and design 8M FP and a timing belt width of 20 mm																	
Speed of the small pulley n_k [min ⁻¹]	Number of teeth on the small pulley z_k																
	22	24	26	28	30	32	34	36	38	40	44	48	52	56	64	72	80
	Pitch diameter of the small pulley d_{wk} [mm]																
	56.02	61.12	66.21	71.30	76.39	81.49	86.58	91.67	96.77	101.86	112.05	122.23	132.42	142.60	162.97	183.35	203.72
10	0.06	0.07	0.08	0.08	0.09	0.10	0.11	0.12	0.13	0.13	0.15	0.17	0.19	0.20	0.24	0.27	0.30
20	0.11	0.13	0.15	0.16	0.18	0.19	0.22	0.24	0.25	0.27	0.30	0.33	0.36	0.39	0.46	0.52	0.58
50	0.28	0.31	0.35	0.39	0.43	0.47	0.51	0.55	0.58	0.62	0.71	0.78	0.86	0.93	1.09	1.24	1.38
100	0.51	0.59	0.67	0.75	0.82	0.90	0.97	1.04	1.13	1.20	1.35	1.50	1.64	1.79	2.08	2.38	2.66
200	0.97	1.13	1.27	1.41	1.57	1.71	1.85	2.00	2.15	2.29	2.58	2.87	3.15	3.43	4.00	4.56	5.12
300	1.41	1.63	1.84	2.06	2.27	2.49	2.70	2.92	3.13	3.34	3.77	4.19	4.61	5.02	5.85	6.67	7.49
400	1.83	2.12	2.40	2.68	2.97	3.25	3.53	3.81	4.09	4.36	4.93	5.47	6.02	6.57	7.65	8.74	9.80
500	2.24	2.59	2.95	3.30	3.65	4.00	4.34	4.69	5.03	5.38	6.05	6.74	7.42	8.09	9.44	10.76	12.08
600	2.64	3.06	3.48	3.90	4.31	4.72	5.14	5.55	5.96	6.36	7.18	7.99	8.79	9.59	11.18	12.76	14.32
700	3.11	3.62	4.11	4.61	5.10	5.59	6.08	6.57	7.05	7.54	8.50	9.46	10.41	11.36	13.25	15.12	16.98
800	3.43	3.98	4.53	5.07	5.61	6.16	6.70	7.23	7.78	8.31	9.37	10.43	11.48	12.53	14.61	16.67	18.72
1000	4.19	4.87	5.54	6.22	6.89	7.56	8.23	8.89	9.55	10.21	11.53	12.83	14.12	15.41	17.97	20.50	23.01
1200	4.94	5.74	6.55	7.35	8.14	8.93	9.72	10.51	11.30	12.08	13.64	15.17	16.70	18.24	21.26	24.26	27.22
1450	5.88	6.85	7.82	8.78	9.73	10.69	11.64	12.58	13.52	14.46	16.32	18.17	20.01	21.84	25.46	29.03	32.56
1600	6.38	7.44	8.49	9.54	10.58	11.62	12.65	13.68	14.70	15.73	17.75	19.76	21.76	23.75	27.68	31.55	35.39
1800	7.09	8.27	9.45	10.61	11.77	12.93	14.09	15.23	16.37	17.51	19.77	22.02	24.23	26.44	30.81	35.11	39.34
2000	7.78	9.09	10.38	11.67	12.95	14.23	15.50	16.76	18.02	19.27	21.76	24.23	26.66	29.10	33.89	38.59	43.21
2200	8.46	9.89	11.30	12.71	14.11	15.50	16.89	18.27	19.64	21.00	23.71	26.40	29.04	31.69	36.89	41.97	46.96
2400	9.14	10.69	12.22	13.75	15.27	16.77	18.28	19.77	21.26	22.73	25.66	28.56	31.42	34.28	39.88	45.35	50.70
2800	10.47	12.25	14.03	15.78	17.53	19.26	20.99	22.70	24.41	26.10	29.46	32.78	36.04	39.30	45.65	51.83	57.82
3000	10.86	12.71	14.55	16.38	18.20	20.00	21.79	23.57	25.35	27.10	30.59	34.02	37.40	40.78	47.34	53.71	59.88
3500	12.72	14.91	17.08	19.23	21.36	23.48	25.59	27.68	29.75	31.81	35.88	39.88	43.78	47.68	55.20		
4000	14.28	16.74	19.19	21.62	24.02	26.40	28.77	31.11	33.43	35.73	40.26	44.72	49.03	53.34			
4500	15.80	18.53	21.25	23.94	26.61	29.24	31.85	34.43	36.98	39.51	44.48	49.34	55.20				
5000	17.27	20.27	23.26	26.20	29.12	32.00	34.83	37.65	40.43	43.16	48.53	53.75					
5500	18.71	21.98	25.20	28.40	31.54	34.66	37.72	40.74	43.73	46.67	52.39	57.92					
6000	20.08	23.66	27.06	30.52	33.86	37.20	40.51	43.69	46.86	50.00	56.05						
6500	21.39	25.32	28.82	32.54	36.06	39.60	43.18	46.46	49.82	53.14	59.47						
7000	22.64	26.97	30.46	34.44	38.14	41.84	45.71	49.05	52.58	56.08							
8000	23.82	28.62	31.96	36.20	40.06	43.92	48.09	51.42	55.12								

Power ratings for other belt widths can be calculated by multiplying by the width correction factors.

Width correction factor				
Profile and design 8M FP				
Standard belt width [mm]	20	30	50	85
Factor	1.00	1.58	2.73	4.76

POWER RATINGS

optibelt **OMEGA FAN POWER** TIMING BELTS

PROFILE AND DESIGN 14M FP



Table 15

Nominal power P_N [kW] for profile and design 14M FP and a timing belt width of 40 mm																	
Speed of the small pulley n_k [min ⁻¹]	Number of teeth on the small pulley z_k																
	28	29	30	32	34	36	38	40	42	44	46	48	52	56	64	72	80
	Pitch diameter of the small pulley d_{wk} [mm]																
	124.78	129.23	133.69	142.60	151.52	160.43	169.34	178.25	187.17	196.08	204.99	213.90	231.73	249.55	285.21	320.86	356.51
10	0.46	0.49	0.51	0.54	0.58	0.62	0.67	0.70	0.74	0.78	0.82	0.86	0.93	1.00	1.15	1.30	1.44
20	0.88	0.91	0.94	1.02	1.11	1.17	1.25	1.32	1.39	1.47	1.54	1.61	1.75	1.90	2.17	2.46	2.73
40	1.62	1.69	1.76	1.90	2.04	2.17	2.32	2.45	2.58	2.72	2.85	2.99	3.25	3.52	4.05	4.56	5.08
60	2.37	2.47	2.57	2.78	2.97	3.18	3.38	3.58	3.78	3.98	4.17	4.36	4.75	5.14	5.92	6.67	7.43
100	3.73	3.89	4.06	4.38	4.71	5.03	5.34	5.67	5.98	6.30	6.61	6.92	7.54	8.16	9.37	10.58	11.78
200	6.91	7.21	7.52	8.12	8.74	9.33	9.93	10.52	11.12	11.71	12.29	12.87	14.03	15.19	17.47	19.71	21.93
300	9.87	10.30	10.74	11.62	12.50	13.36	14.22	15.08	15.93	16.78	17.62	18.46	20.12	21.78	25.05	28.28	31.46
400	12.68	13.26	13.83	14.96	16.08	17.21	18.33	19.42	20.53	21.63	22.71	23.80	25.95	28.09	32.31	36.47	40.56
500	15.40	16.09	16.79	18.17	19.56	20.92	22.28	23.64	24.97	26.30	27.63	28.95	31.56	34.18	39.31	44.36	49.33
600	18.02	18.85	19.67	21.30	22.91	24.53	26.12	27.70	29.28	30.86	32.40	33.95	37.02	40.09	46.09	51.99	57.80
700	21.08	22.05	23.01	24.93	26.83	28.73	30.60	32.46	34.31	36.15	37.97	39.79	43.38	46.96	53.99	60.87	67.63
800	23.08	24.14	25.20	27.29	29.38	31.45	33.51	35.56	37.58	39.60	41.59	43.59	47.51	51.43	59.11	66.62	73.99
1000	27.92	29.21	30.50	33.04	35.58	38.09	40.59	43.06	45.51	47.97	50.37	52.78	57.52	62.25	71.48	80.46	89.22
1200	32.57	34.08	35.59	38.57	41.54	44.48	47.40	50.28	53.14	56.00	58.81	61.61	67.10	72.60	83.25	93.56	103.56
1450	38.39	40.17	41.95	45.50	48.99	52.46	55.89	59.29	62.64	66.00	69.28	72.57	78.96	85.35	97.68	109.49	120.81
1600	41.42	43.35	45.27	49.09	52.86	56.60	60.30	63.97	67.58	71.18	74.71	78.23	85.08	91.93	105.03	117.53	129.41
1800	45.63	47.76	49.89	54.09	58.26	62.36	66.44	70.44	74.39	78.34	82.20	86.05	93.49	100.92	115.03	128.36	
2000	49.73	52.05	54.38	58.95	63.48	67.94	72.35	76.70	80.97	85.24	89.39	93.54	101.49	109.45	124.42		
2200	53.65	56.15	58.65	63.58	68.45	73.24	77.96	82.62	87.17	91.71	96.12	100.52	108.90	117.28			
2400	57.57	60.25	62.92	68.21	73.43	78.54	83.58	88.54	93.36	98.19	102.85	107.51	116.31	125.11			
2600	61.25	64.10	66.95	72.55	78.06	83.46	88.78	93.99	99.04	104.10	108.95	113.81					
2850	64.94	67.96	70.98	76.89	82.70	88.38	93.98	99.44	104.72	110.01	115.06	120.10					
3000	67.06	70.17	73.28	79.38	85.35	91.20	96.93	102.52	107.93	113.33	118.46	123.60					
3500	76.79	80.30	83.81	90.67	97.34	103.81	110.10	116.20	110.88	116.25	121.48						
4000	84.40	88.20	92.00	99.37	106.48	113.77	121.68	127.06	113.44	118.75							
4500	91.28	95.30	99.33	105.43	113.73	121.63	132.00	135.53									
5000	97.36	101.56	105.73	108.83	119.75	127.31											
5500	102.61	106.91	111.16	109.50													
6000	106.99	111.30															

Power ratings for other belt widths can be calculated by multiplying by the width correction factors.

Width correction factor					
Profile and design 14M FP					
Standard belt width [mm]	40	55	85	115	170
Factor	1.00	1.44	2.50	3.50	5.32

POWER RATINGS

optibelt **OMEGA HP** TIMING BELTS

PROFILE AND DESIGN 3M HP



Table 16

Nominal power P_N [W] for profile and design 3M HP and a timing belt width of 9 mm															
Speed of the small pulley n_k [min ⁻¹]	Number of teeth on the small pulley z_k														
	10	12	14	16	18	20	24	28	32	40	48	56	64	72	80
	Pitch diameter of the small pulley d_{wk} (mm)														
	9.55	11.46	13.37	15.28	17.19	19.10	22.92	26.74	30.56	38.20	45.84	53.48	61.12	68.75	76.39
20	2.7	3.4	4.1	4.8	5.6	6.4	8.0	9.8	11.5	14.9	18.4	21.6	24.5	27.3	30.0
40	5.2	6.5	7.8	9.2	10.7	12.1	15.2	18.6	21.8	28.5	35.0	41.2	46.7	52.0	57.3
60	7.6	9.5	11.4	13.4	15.5	17.7	22.2	27.0	31.8	41.4	51.0	60.1	68.0	75.8	83.5
100	12.3	15.3	18.4	21.7	25.1	28.7	36.0	43.5	50.9	66.1	81.6	96.3	109.3	122.2	134.7
200	23.3	28.9	34.8	40.9	47.4	54.1	67.7	81.9	95.5	125.0	154.7	183.0	207.1	231.6	255.9
300	31.6	39.4	47.7	56.3	65.6	74.7	93.8	113.6	133.0	173.9	215.1	253.9	287.6	321.9	354.5
400	39.6	49.4	59.7	70.6	82.0	93.3	116.7	141.0	165.6	216.0	268.0	315.6	358.2	400.2	441.5
500	46.3	58.1	70.6	83.6	97.3	111.3	138.6	167.6	197.0	255.8	317.1	372.8	423.0	473.3	521.3
600	52.3	65.6	80.1	95.3	112.1	128.1	160.0	192.4	226.5	294.0	363.6	426.9	485.0	541.8	597.5
700	58.6	73.9	90.0	106.9	125.6	143.7	180.5	217.4	254.7	330.1	407.7	478.8	544.0	607.6	669.7
800	66.1	82.8	100.2	118.6	138.5	158.5	199.2	240.6	281.3	365.0	451.0	529.0	601.0	671.0	739.0
900	71.5	89.0	109.3	129.7	152.0	173.5	217.4	262.8	307.9	399.0	491.0	577.0	655.0	731.0	807.0
950	74.0	92.7	113.3	135.0	157.8	180.8	226.5	273.4	320.6	415.0	512.0	600.0	682.0	761.0	839.0
1000	76.5	96.3	117.4	140.3	164.5	188.1	235.7	284.1	333.2	432.0	531.0	624.0	708.0	791.0	871.0
1200	86.3	109.3	133.7	160.0	187.7	214.8	270.7	326.5	382.2	496.0	609.0	713.0	809.0	902.0	994.0
1400	96.0	122.0	149.7	179.1	211.0	241.7	303.4	366.0	428.2	554.0	680.0	797.0	903.0	1009.0	1110.0
1450	98.5	124.8	153.7	183.6	216.8	247.8	311.9	375.0	439.1	569.0	698.0	818.0	927.0	1034.0	1139.0
1600	106.4	135.2	164.9	197.4	232.5	266.6	335.1	404.3	473.1	611.0	749.0	877.0	995.0	1110.0	1221.0
1800	117.0	148.0	180.0	215.0	253.0	290.0	365.0	440.0	515.0	667.0	816.0	955.0	1082.0	1207.0	1326.0
2000	125.0	158.0	193.0	231.0	272.0	312.0	395.0	475.0	557.0	718.0	879.0	1029.0	1165.0	1298.0	1427.0
2400	141.0	178.0	219.0	263.0	309.0	356.0	450.0	543.0	635.0	819.0	1000.0	1168.0	1322.0	1471.0	1613.0
2850	155.0	198.0	245.0	296.0	350.0	403.0	509.0	614.0	718.0	923.0	1125.0	1313.0	1484.0	1648.0	1792.0
3200	170.0	216.0	266.0	320.0	379.0	436.0	552.0	665.0	779.0	1001.0	1218.0	1419.0	1601.0	1775.0	1940.0
3600	182.0	233.0	287.0	347.0	411.0	473.0	599.0	722.0	845.0	1084.0	1317.0	1531.0	1724.0	1907.0	2079.0
4000	194.0	248.0	308.0	372.0	441.0	508.0	644.0	776.0	907.0	1163.0	1409.0	1635.0	1837.0	2028.0	2203.0
5000	221.0	284.0	352.0	427.0	507.0	587.0	743.0	896.0	1047.0	1335.0	1608.0	1853.0	2065.0	2257.0	2425.0
6000	246.0	317.0	395.0	479.0	571.0	661.0	838.0	1011.0	1178.0	1495.0	1788.0	2045.0	2257.0	2440.0	2587.0
7000	265.0	344.0	429.0	523.0	625.0	724.0	919.0	1105.0	1286.0	1621.0	1919.0	2169.0	2359.0	2506.0	2598.0
8000	284.0	368.0	462.0	564.0	676.0	784.0	994.0	1194.0	1385.0	1733.0	2030.0	2264.0	2420.0	2517.0	2537.0
10000	320.0	418.0	515.0	632.0	759.0	880.0	1114.0	1334.0	1534.0	1877.0	2128.0	2277.0	2393.0		
12000	349.0	452.0	566.0	690.0	822.0	954.0	1204.0	1428.0	1624.0	1920.0	2064.0				
14000	347.0	458.0	583.0	721.0	869.0	1006.0	1260.0	1476.0	1651.0	1856.0					

Power ratings for other belt widths can be calculated by multiplying by the width correction factors.

Width correction factor							
Profile and design 3M HP							
Belt width [mm]	3	Standard 6	Standard 9	12	Standard 15	20	25
Factor	0.28	0.61	1.00	1.44	1.87	2.63	3.40

POWER RATINGS

optibelt **OMEGA HP** TIMING BELTS

PROFILE AND DESIGN 5M HP



Table 17

Nominal power P_N [kW] for profile and design 5M HP and a timing belt width of 9 mm															
Speed of the small pulley n_k [min ⁻¹]	Number of teeth on the small pulley z_k														
	14	16	18	20	24	28	32	36	40	44	48	56	64	72	80
	Pitch diameter of the small pulley d_{wk} [mm]														
	22.28	25.46	28.65	31.83	38.20	44.56	50.93	57.30	63.66	70.03	76.39	89.13	101.86	114.59	127.32
700	0.36	0.44	0.53	0.61	0.77	0.93	1.09	1.25	1.43	1.59	1.76	2.09	2.43	2.76	3.09
950	0.45	0.56	0.68	0.78	0.99	1.20	1.40	1.62	1.83	2.05	2.25	2.68	3.09	3.52	3.92
1450	0.62	0.79	0.94	1.09	1.39	1.68	1.98	2.27	2.56	2.85	3.14	3.70	4.26	4.80	5.32
2850	1.04	1.32	1.58	1.83	2.32	2.79	3.27	3.71	4.15	4.59	5.00	5.77	6.49	7.12	7.68
20	0.01	0.02	0.02	0.02	0.03	0.03	0.05	0.06	0.06	0.07	0.07	0.09	0.10	0.12	0.14
40	0.03	0.03	0.05	0.05	0.06	0.08	0.09	0.10	0.12	0.13	0.14	0.17	0.20	0.22	0.25
60	0.05	0.06	0.06	0.07	0.09	0.10	0.13	0.15	0.16	0.18	0.21	0.24	0.28	0.32	0.37
100	0.07	0.08	0.10	0.12	0.14	0.17	0.20	0.23	0.26	0.29	0.32	0.38	0.45	0.51	0.58
200	0.13	0.15	0.18	0.21	0.26	0.31	0.37	0.43	0.48	0.54	0.60	0.71	0.83	0.94	1.07
300	0.17	0.22	0.25	0.30	0.37	0.45	0.53	0.61	0.69	0.77	0.85	1.01	1.18	1.36	1.52
400	0.22	0.28	0.32	0.38	0.47	0.58	0.68	0.78	0.89	0.99	1.09	1.30	1.52	1.74	1.94
500	0.26	0.33	0.39	0.46	0.58	0.70	0.82	0.94	1.07	1.20	1.32	1.58	1.83	2.09	2.35
600	0.31	0.39	0.46	0.53	0.68	0.82	0.95	1.10	1.25	1.39	1.54	1.84	2.14	2.44	2.73
800	0.39	0.49	0.59	0.68	0.86	1.04	1.22	1.40	1.59	1.77	1.96	2.33	2.70	3.07	3.44
900	0.44	0.54	0.64	0.75	0.94	1.15	1.35	1.55	1.75	1.96	2.16	2.56	2.97	3.37	3.77
1000	0.47	0.59	0.70	0.82	1.04	1.25	1.47	1.69	1.91	2.13	2.35	2.78	3.22	3.66	4.08
1200	0.54	0.68	0.82	0.94	1.20	1.45	1.70	1.96	2.21	2.46	2.71	3.21	3.70	4.20	4.67
1400	0.61	0.77	0.92	1.07	1.36	1.63	1.92	2.21	2.50	2.77	3.06	3.61	4.15	4.68	5.20
1600	0.68	0.85	1.02	1.18	1.51	1.82	2.14	2.45	2.76	3.07	3.38	3.98	4.57	5.13	5.68
1800	0.74	0.93	1.12	1.30	1.64	1.99	2.33	2.68	3.01	3.35	3.68	4.32	4.95	5.54	6.12
2000	0.79	1.01	1.22	1.40	1.78	2.16	2.53	2.90	3.25	3.61	3.97	4.65	5.30	5.92	6.51
2400	0.91	1.16	1.39	1.61	2.05	2.47	2.89	3.30	3.70	4.11	4.49	5.22	5.92	6.57	7.15
3200	1.12	1.44	1.71	1.99	2.52	3.02	3.53	4.00	4.47	4.92	5.35	6.14	6.84	7.44	7.95
3600	1.21	1.55	1.86	2.16	2.73	3.28	3.81	4.31	4.80	5.26	5.69	6.47	7.15	7.69	8.12
4000	1.30	1.67	2.00	2.32	2.92	3.51	4.06	4.59	5.08	5.55	5.98	6.75	7.37	7.83	8.14
5000	1.50	1.93	2.31	2.68	3.36	4.00	4.60	5.15	5.65	6.10	6.50	7.13	7.53	7.68	7.58
6000	1.67	2.16	2.59	2.99	3.73	4.39	5.00	5.54	6.01	6.41	6.73	7.12	7.16	6.85	6.19
7000	1.82	2.36	2.82	3.24	4.03	4.70	5.30	5.80	6.20	6.49	6.68	6.73	6.30	5.39	
8000	1.94	2.52	3.01	3.46	4.26	4.93	5.47	5.90	6.20	6.36	6.38	5.98			
10000	2.15	2.79	3.32	3.78	4.57	5.14	5.54	5.73	5.72	5.50	5.05				
12000	2.30	2.98	3.52	3.97	4.66	5.08	5.22	5.07	4.62	3.88					
14000	2.39	3.09	3.62	4.04	4.58	4.75	4.55	3.96	2.97						

Power ratings for other belt widths can be calculated by multiplying by the width correction factors.

Width correction factor							
Profile and design 5M HP							
Belt width [mm]	6	Standard 9	12	Standard 15	20	Standard 25	30
Factor	0.61	1.00	1.44	1.87	2.63	3.40	4.15

POWER RATINGS

optibelt **OMEGA HP** TIMING BELTS

PROFILE AND DESIGN 8M HP



Table 18

Nominal power P_N [kW] for profile and design 8M HP and a timing belt width of 20 mm																	
Speed of the small pulley n_k [min ⁻¹]	Number of teeth on the small pulley z_k																
	22	24	26	28	30	32	34	36	38	40	44	48	52	56	64	72	80
	Pitch diameter of the small pulley d_{wk} [mm]																
	56.02	61.12	66.21	71.30	76.39	81.49	86.58	91.67	96.77	101.86	112.05	122.23	132.42	142.60	162.97	183.35	203.72
10	0.06	0.07	0.08	0.08	0.09	0.10	0.11	0.12	0.13	0.13	0.15	0.17	0.19	0.20	0.24	0.27	0.30
20	0.11	0.13	0.15	0.16	0.18	0.19	0.22	0.24	0.25	0.27	0.30	0.33	0.36	0.39	0.46	0.52	0.58
50	0.28	0.31	0.35	0.39	0.43	0.47	0.51	0.55	0.58	0.62	0.71	0.78	0.86	0.93	1.09	1.24	1.38
100	0.51	0.59	0.67	0.75	0.82	0.90	0.97	1.04	1.13	1.20	1.35	1.50	1.64	1.79	2.08	2.38	2.66
200	0.97	1.13	1.27	1.41	1.57	1.71	1.85	2.00	2.15	2.29	2.58	2.87	3.15	3.43	4.00	4.56	5.12
300	1.41	1.63	1.84	2.06	2.27	2.49	2.70	2.92	3.13	3.34	3.77	4.19	4.61	5.02	5.85	6.67	7.49
400	1.83	2.12	2.40	2.68	2.97	3.25	3.53	3.81	4.09	4.36	4.93	5.47	6.02	6.57	7.65	8.74	9.80
500	2.24	2.59	2.95	3.30	3.65	4.00	4.34	4.69	5.03	5.38	6.05	6.74	7.42	8.09	9.44	10.76	12.08
600	2.64	3.06	3.48	3.90	4.31	4.72	5.14	5.55	5.96	6.36	7.18	7.99	8.79	9.59	11.18	12.76	14.32
700	3.11	3.62	4.11	4.61	5.10	5.59	6.08	6.57	7.05	7.54	8.50	9.46	10.41	11.36	13.25	15.12	16.98
800	3.43	3.98	4.53	5.07	5.61	6.16	6.70	7.23	7.78	8.31	9.37	10.43	11.48	12.53	14.61	16.67	18.72
1000	4.19	4.87	5.54	6.22	6.89	7.56	8.23	8.89	9.55	10.21	11.53	12.83	14.12	15.41	17.97	20.50	23.01
1200	4.94	5.74	6.55	7.35	8.14	8.93	9.72	10.51	11.30	12.08	13.64	15.17	16.70	18.24	21.26	24.26	27.22
1450	5.88	6.85	7.82	8.78	9.73	10.69	11.64	12.58	13.52	14.46	16.32	18.17	20.01	21.84	25.46	29.03	32.56
1600	6.38	7.44	8.49	9.54	10.58	11.62	12.65	13.68	14.70	15.73	17.75	19.76	21.76	23.75	27.68	31.55	35.39
1800	7.09	8.27	9.45	10.61	11.77	12.93	14.09	15.23	16.37	17.51	19.77	22.02	24.23	26.44	30.81	35.11	39.34
2000	7.78	9.09	10.38	11.67	12.95	14.23	15.50	16.76	18.02	19.27	21.76	24.23	26.66	29.10	33.89	38.59	43.21
2200	8.46	9.89	11.30	12.71	14.11	15.50	16.89	18.27	19.64	21.00	23.71	26.40	29.04	31.69	36.89	41.97	46.96
2400	9.14	10.69	12.22	13.75	15.27	16.77	18.28	19.77	21.26	22.73	25.66	28.56	31.42	34.28	39.88	45.35	50.70
2800	10.47	12.25	14.03	15.78	17.53	19.26	20.99	22.70	24.41	26.10	29.46	32.78	36.04	39.30	45.65	51.83	57.82
3000	10.86	12.71	14.55	16.38	18.20	20.00	21.79	23.57	25.35	27.10	30.59	34.02	37.40	40.78	47.34	53.71	59.88
3500	12.72	14.91	17.08	19.23	21.36	23.48	25.59	27.68	29.75	31.81	35.88	39.88	43.78	47.68	55.20		
4000	14.28	16.74	19.19	21.62	24.02	26.40	28.77	31.11	33.43	35.73	40.26	44.72	49.03	53.34			
4500	15.80	18.53	21.25	23.94	26.61	29.24	31.85	34.43	36.98	39.51	44.48	49.34	55.20				
5000	17.27	20.27	23.26	26.20	29.12	32.00	34.83	37.65	40.43	43.16	48.53	53.75					
5500	18.71	21.98	25.20	28.40	31.54	34.66	37.72	40.74	43.73	46.67	52.39	57.92					
6000	20.08	23.66	27.06	30.52	33.86	37.20	40.51	43.69	46.86	50.00	56.05						
6500	21.39	25.32	28.82	32.54	36.06	39.60	43.18	46.46	49.82	53.14	59.47						
7000	22.64	26.97	30.46	34.44	38.14	41.84	45.71	49.05	52.58	56.08							
8000	23.82	28.62	31.96	36.20	40.06	43.92	48.09	51.42	55.12								

Power ratings for other belt widths can be calculated by multiplying by the width correction factors.

Width correction factor				
Profile and design 8M HP				
Standard belt width [mm]	20	30	50	85
Factor	1.00	1.58	2.73	4.76

POWER RATINGS

optibelt **OMEGA HP** TIMING BELTS

PROFILE AND DESIGN 14M HP



Table 19

Nominal power P_N [kW] for profile and design 14M HP and a timing belt width of 40 mm																	
Speed of the small pulley n_k [min ⁻¹]	Number of teeth on the small pulley z_k																
	28	29	30	32	34	36	38	40	42	44	46	48	52	56	64	72	80
	Pitch diameter of the small pulley d_{wk} [mm]																
	124.78	129.23	133.69	142.60	151.52	160.43	169.34	178.25	187.17	196.08	204.99	213.90	231.73	249.55	285.21	320.86	356.51
10	0.46	0.49	0.51	0.54	0.58	0.62	0.67	0.70	0.74	0.78	0.82	0.86	0.93	1.00	1.15	1.30	1.44
20	0.88	0.91	0.94	1.02	1.11	1.17	1.25	1.32	1.39	1.47	1.54	1.61	1.75	1.90	2.17	2.46	2.73
40	1.62	1.69	1.76	1.90	2.04	2.17	2.32	2.45	2.58	2.72	2.85	2.99	3.25	3.52	4.05	4.56	5.08
60	2.37	2.47	2.57	2.78	2.97	3.18	3.38	3.58	3.78	3.98	4.17	4.36	4.75	5.14	5.92	6.67	7.43
100	3.73	3.89	4.06	4.38	4.71	5.03	5.34	5.67	5.98	6.30	6.61	6.92	7.54	8.16	9.37	10.58	11.78
200	6.91	7.21	7.52	8.12	8.74	9.33	9.93	10.52	11.12	11.71	12.29	12.87	14.03	15.19	17.47	19.71	21.93
300	9.87	10.30	10.74	11.62	12.50	13.36	14.22	15.08	15.93	16.78	17.62	18.46	20.12	21.78	25.05	28.28	31.46
400	12.68	13.26	13.83	14.96	16.08	17.21	18.33	19.42	20.53	21.63	22.71	23.80	25.95	28.09	32.31	36.47	40.56
500	15.40	16.09	16.79	18.17	19.56	20.92	22.28	23.64	24.97	26.30	27.63	28.95	31.56	34.18	39.31	44.36	49.33
600	18.02	18.85	19.67	21.30	22.91	24.53	26.12	27.70	29.28	30.86	32.40	33.95	37.02	40.09	46.09	51.99	57.80
700	21.08	22.05	23.01	24.93	26.83	28.73	30.60	32.46	34.31	36.15	37.97	39.79	43.38	46.96	53.99	60.87	67.63
800	23.08	24.14	25.20	27.29	29.38	31.45	33.51	35.56	37.58	39.60	41.59	43.59	47.51	51.43	59.11	66.62	73.99
1000	27.92	29.21	30.50	33.04	35.58	38.09	40.59	43.06	45.51	47.97	50.37	52.78	57.52	62.25	71.48	80.46	89.22
1200	32.57	34.08	35.59	38.57	41.54	44.48	47.40	50.28	53.14	56.00	58.81	61.61	67.10	72.60	83.25	93.56	103.56
1450	38.39	40.17	41.95	45.50	48.99	52.46	55.89	59.29	62.64	66.00	69.28	72.57	78.96	85.35	97.68	109.49	120.81
1600	41.42	43.35	45.27	49.09	52.86	56.60	60.30	63.97	67.58	71.18	74.71	78.23	85.08	91.93	105.03	117.53	129.41
1800	45.63	47.76	49.89	54.09	58.26	62.36	66.44	70.44	74.39	78.34	82.20	86.05	93.49	100.92	115.03	128.36	
2000	49.73	52.05	54.38	58.95	63.48	67.94	72.35	76.70	80.97	85.24	89.39	93.54	101.49	109.45	124.42		
2200	53.65	56.15	58.65	63.58	68.45	73.24	77.96	82.62	87.17	91.71	96.12	100.52	108.90	117.28			
2400	57.57	60.25	62.92	68.21	73.43	78.54	83.58	88.54	93.36	98.19	102.85	107.51	116.31	125.11			
2600	61.25	64.10	66.95	72.55	78.06	83.46	88.78	93.99	99.04	104.10	108.95	113.81					
2850	64.94	67.96	70.98	76.89	82.70	88.38	93.98	99.44	104.72	110.01	115.06	120.10					
3000	67.06	70.17	73.28	79.38	85.35	91.20	96.93	102.52	107.93	113.33	118.46	123.60					
3500	76.79	80.30	83.81	90.67	97.34	103.81	110.10	116.20	110.88	116.25	121.48						
4000	84.40	88.20	92.00	99.37	106.48	113.77	121.68	127.06	113.44	118.75							
4500	91.28	95.30	99.33	105.43	113.73	121.63	132.00	135.53									
5000	97.36	101.56	105.73	108.83	119.75	127.31											
5500	102.61	106.91	111.16	109.50													
6000	106.99	111.30															

Power ratings for other belt widths can be calculated by multiplying by the width correction factors.

Width correction factor					
Profile and design 14M HP					
Standard belt width [mm]	40	55	85	115	170
Factor	1.00	1.44	2.50	3.50	5.32

POWER RATINGS

optibelt **OMEGA** TIMING BELTS

PROFILE AND DESIGN 2M



Table 20

Nominal power P_N [W] for profile and design 2M and a timing belt width of 9 mm																
Speed of the small pulley n_k [min ⁻¹]	Number of teeth on the small pulley z_k															
	10	12	14	16	18	20	24	28	32	36	40	48	56	64	72	80
	Pitch diameter of the small pulley d_{wk} [mm]															
	6.37	7.64	8.91	10.19	11.46	12.73	15.28	17.83	20.37	22.92	25.46	30.56	35.65	40.74	45.84	50.93
20	0.39	0.48	0.57	0.66	0.75	0.85	1.03	1.23	1.42	1.62	1.82	2.21	2.62	3.02	3.43	3.84
40	0.79	0.96	1.14	1.33	1.52	1.71	2.08	2.46	2.85	3.24	3.63	4.42	5.22	6.02	6.82	7.64
60	1.18	1.44	1.72	1.99	2.27	2.55	3.10	3.67	4.25	4.82	5.41	6.58	7.76	8.96	10.16	11.37
100	1.97	2.41	2.85	3.30	3.75	4.21	5.13	6.07	7.02	7.97	8.93	10.88	12.86	14.80	16.77	18.72
200	3.90	4.75	5.63	6.52	7.41	8.31	10.11	11.96	13.83	15.70	17.57	21.36	25.22	29.07	32.94	36.94
300	5.78	7.07	8.37	9.68	11.02	12.38	15.09	17.79	20.55	23.35	26.13	31.75	37.47	43.23	48.99	54.83
400	7.67	9.36	11.12	12.79	14.56	16.34	19.93	23.57	27.20	30.83	34.51	42.03	49.60	57.17	64.82	72.61
500	9.53	11.64	13.72	15.91	18.10	20.29	24.71	29.24	33.80	38.37	42.96	52.26	61.62	71.10	80.63	90.16
600	11.42	13.93	16.43	19.04	21.64	24.24	29.55	34.95	40.35	45.79	51.30	62.42	73.63	84.92	96.34	107.70
700	13.24	16.16	19.08	22.10	25.12	28.16	34.32	40.58	46.86	53.45	59.93	72.50	85.53	98.65	111.87	125.12
800	15.10	18.40	21.70	25.20	28.60	32.10	39.10	46.20	53.40	61.10	68.60	82.60	97.40	112.40	127.40	142.50
900	16.90	20.60	24.40	28.20	32.10	36.00	43.80	51.80	59.80	68.20	76.40	92.60	109.20	126.00	142.90	159.80
950	17.80	21.70	25.70	29.70	33.80	37.90	46.20	54.60	63.00	71.70	80.30	97.60	115.10	132.80	150.60	168.50
1000	18.70	22.90	27.00	31.20	35.60	39.90	48.50	57.40	66.30	75.20	84.30	102.60	121.00	139.60	158.30	177.10
1200	22.30	27.20	32.20	37.30	42.40	47.50	57.90	68.40	79.00	89.80	100.60	122.40	144.40	166.60	189.00	211.50
1400	25.90	31.60	37.40	43.30	49.20	55.20	67.30	79.50	91.80	104.30	116.80	142.20	167.80	193.60	219.50	245.60
1450	26.80	32.70	38.70	44.80	50.90	57.10	69.60	82.20	95.00	107.90	120.80	147.10	173.60	200.30	227.10	254.10
1600	29.40	36.00	42.50	49.20	55.90	62.80	76.60	90.50	104.50	118.70	133.00	161.90	190.90	220.40	249.90	279.60
1800	32.90	40.30	47.70	55.20	62.80	70.40	85.70	101.40	117.10	133.00	149.10	181.40	214.00	247.00	280.10	313.50
2000	36.50	44.60	52.80	61.00	69.40	77.90	95.00	112.30	129.70	147.30	165.10	200.90	237.00	273.50	310.20	347.20
2400	43.50	53.20	62.90	72.80	82.80	92.90	113.20	133.80	154.60	175.70	196.80	239.60	282.70	326.30	370.10	414.20
2850	51.30	62.70	74.20	85.90	98.00	109.80	133.60	158.00	182.50	207.40	232.40	282.90	333.80	385.20	436.90	489.00
3200	57.40	70.10	82.90	96.10	112.10	124.00	149.40	176.60	204.10	231.90	259.80	316.30	373.30	430.80	488.70	546.90
3600	64.20	78.50	92.90	107.50	122.20	137.20	167.30	197.80	228.60	259.60	291.00	354.30	418.10	482.60	547.40	612.60
4000	71.00	86.80	102.80	118.90	135.20	151.80	185.10	218.80	252.90	287.30	322.00	392.10	462.70	534.00	605.80	678.10
5000	87.90	107.40	127.20	147.10	167.50	187.90	229.10	270.70	313.00	355.80	398.80	485.70	573.10	661.70	750.50	840.20
6000	104.50	127.70	151.30	175.00	199.20	223.50	272.60	322.40	372.70	423.40	474.60	578.10	682.30	787.70	893.60	1000.40
7000	120.80	147.60	174.90	202.40	230.30	258.50	315.40	373.00	431.20	489.90	549.20	669.00	789.60	911.70	1034.40	1158.10
8000	137.10	167.50	198.50	229.80	261.40	293.50	358.10	423.50	489.70	556.40	623.80	759.90	897.00	1035.70	1175.20	1315.70
10000	169.00	206.00	245.00	283.00	322.00	362.00	442.00	522.00	604.00	687.00	770.00	938.00	1107.00	1279.00	1451.00	1625.00
12000	200.00	245.00	290.00	336.00	382.00	429.00	524.00	619.00	716.00	814.00	913.00	1113.00	1314.00	1517.00	1722.00	1928.00
14000	230.00	282.00	334.00	387.00	440.00	494.00	604.00	714.00	826.00	939.00	1053.00	1284.00	1516.00	1692.00	1751.00	1988.00

Power ratings for other belt widths can be calculated by multiplying by the width correction factors.

Width correction factor				
Profile and design 2M				
Belt width [mm]	Standard 3	Standard 6	Standard 9	12
Factor	0.28	0.61	1.00	1.44

POWER RATINGS

optibelt **OMEGA** TIMING BELTS

PROFILE AND DESIGN 3M



Table 21

Nominal power P_N [W] for profile and design 3M and a timing belt width of 9 mm															
Speed of the small pulley n_k [min ⁻¹]	Number of teeth on the small pulley z_k														
	10	12	14	16	18	20	24	28	32	40	48	56	64	72	80
	Pitch diameter of the small pulley d_{wk} [mm]														
	9.55	11.46	13.37	15.28	17.19	19.10	22.92	26.74	30.56	38.20	45.84	53.48	61.12	68.75	76.39
20	1.6	1.6	1.6	1.6	3.2	3.2	3.2	4.8	4.8	6.4	9.6	11.2	12.8	12.8	14.4
40	3.2	3.2	3.2	4.8	4.8	4.8	6.4	8.0	9.6	14.4	17.6	20.9	24.1	27.3	31.0
60	3.2	4.8	4.8	6.4	8.0	8.0	11.2	12.8	16.0	20.9	27.3	32.6	37.4	40.6	45.5
100	6.4	8.0	9.6	11.2	12.8	14.4	17.6	20.9	25.7	34.2	45.5	53.5	62.0	68.4	76.5
200	12.8	16.0	17.6	20.9	24.1	27.3	35.8	43.9	51.9	70.1	89.8	107.5	122.5	136.9	153.5
300	17.6	20.9	25.7	29.4	34.2	39.0	48.7	58.8	70.1	94.7	120.9	142.2	163.1	182.9	204.3
400	20.9	25.7	31.0	37.4	42.2	48.7	60.4	73.3	86.6	116.0	147.1	174.9	199.5	225.7	249.7
500	25.7	31.0	37.4	43.9	50.3	57.2	71.7	86.6	101.1	135.3	173.3	204.3	233.7	263.1	292.5
600	29.4	35.8	43.9	50.3	57.2	65.2	81.3	97.9	116.0	155.1	196.3	232.1	266.3	298.9	331.6
700	32.6	40.6	48.7	57.2	65.2	73.3	91.4	110.7	130.5	173.3	218.7	259.9	295.7	333.2	371.1
800	37.4	45.5	53.5	63.6	71.7	81.3	101.1	122.5	143.9	190.9	241.7	284.5	325.1	366.3	407.0
900	40.6	48.7	58.8	68.4	78.1	89.8	110.7	133.7	156.7	207.5	261.5	309.1	352.9	397.3	441.2
950	42.2	51.9	62.0	71.7	81.3	93.0	116.0	138.5	163.1	215.5	272.7	321.9	367.9	413.4	459.4
1000	43.9	53.5	63.6	74.9	85.0	96.3	119.3	143.9	170.1	223.5	282.9	333.2	380.7	428.3	475.4
1200	50.3	62.0	73.3	85.0	97.9	110.7	136.9	164.7	194.1	255.1	321.9	379.1	433.2	487.2	539.6
1400	57.2	70.1	82.9	96.3	110.7	124.1	153.5	184.5	217.1	286.1	357.8	421.9	482.4	541.2	601.6
1450	58.8	71.7	85.0	99.5	112.8	127.3	158.3	189.3	223.5	292.5	367.9	431.6	493.6	554.0	616.0
1600	63.6	76.5	91.4	105.9	122.5	136.9	170.1	204.3	240.1	313.9	394.1	462.6	527.8	593.6	658.8
1800	68.4	85.0	101.1	117.6	133.7	150.3	186.1	221.9	261.5	341.7	426.7	501.6	573.8	643.9	714.4
2000	74.9	91.4	109.1	125.7	145.5	163.1	201.1	241.7	282.9	369.5	459.4	541.2	616.0	691.4	766.8
2400	86.0	106.0	126.0	145.0	167.0	188.0	231.0	277.0	323.0	421.0	523.0	614.0	700.0	785.0	869.0
2850	98.0	119.0	141.0	163.0	186.0	211.0	259.0	309.0	362.0	470.0	582.0	682.0	777.0	869.0	961.0
3200	108.0	132.0	157.0	182.0	206.0	232.0	286.0	342.0	398.0	516.0	637.0	746.0	847.0	947.0	1046.0
3600	119.0	144.0	172.0	198.0	226.0	254.0	313.0	372.0	434.0	560.0	690.0	806.0	915.0	1020.0	1123.0
4000	129.0	157.0	185.0	214.0	245.0	275.0	337.0	401.0	467.0	603.0	739.0	862.0	977.0	1087.0	1192.0
5000	154.0	186.0	219.0	254.0	290.0	324.0	398.0	472.0	547.0	700.0	854.0	988.0	1111.0	1228.0	1334.0
6000	177.0	214.0	252.0	291.0	331.0	372.0	454.0	536.0	619.0	788.0	952.0	1093.0	1218.0	1331.0	1428.0
7000	198.0	241.0	283.0	327.0	372.0	416.0	506.0	596.0	687.0	865.0	1034.0	1177.0	1295.0	1393.0	1469.0
8000	219.0	267.0	313.0	362.0	409.0	457.0	555.0	652.0	747.0	933.0	1103.0	1236.0	1338.0	1411.0	1451.0
10000	260.0	314.0	370.0	424.0	480.0	534.0	644.0	749.0	851.0	1034.0	1187.0	1280.0	1318.0	1298.0	1211.0
12000	298.0	360.0	421.0	483.0	544.0	603.0	718.0	828.0	928.0	1092.0	1195.0	1211.0	1133.0		
14000	334.0	401.0	469.0	536.0	600.0	662.0	780.0	887.0	977.0	1098.0	1120.0	1010.0			

Power ratings for other belt widths can be calculated by multiplying by the width correction factors.

Width correction factor							
Profile and design 3M							
Belt width [mm]	3	Standard 6	Standard 9	12	Standard 15	20	25
Factor	0.28	0.61	1.00	1.44	1.87	2.63	3.40

POWER RATINGS

optibelt **OMEGA** TIMING BELTS

PROFILE AND DESIGN 5M



Table 22

Nominal power P_N [W] for profile and design 5M and a timing belt width of 9 mm															
Speed of the small pulley n_k [min ⁻¹]	Number of teeth on the small pulley z_k														
	14	16	18	20	24	28	32	36	40	44	48	56	64	72	80
	Pitch diameter of the small pulley d_{wk} [mm]														
	22.28	25.46	28.65	31.83	38.20	44.56	50.93	57.30	63.66	70.03	76.39	89.13	101.86	114.59	127.32
20	3.7	4.9	5.8	6.9	8.9	11.0	13.0	15.0	17.0	19.9	22.8	26.8	30.8	34.0	38.0
40	8.9	11.0	11.8	13.8	17.9	21.0	25.9	30.0	34.9	40.1	45.0	53.9	61.1	68.9	76.9
60	13.0	15.9	17.9	21.0	25.9	32.0	38.0	45.0	51.9	59.9	68.0	80.1	91.9	103.2	115.0
100	21.9	25.9	30.0	34.9	44.1	53.9	64.0	74.9	87.0	100.0	113.0	134.3	153.3	172.3	192.2
200	45.0	53.0	61.1	68.9	88.2	107.2	128.2	150.1	174.4	199.4	226.2	268.6	306.6	345.5	383.9
300	61.0	72.0	83.0	94.0	119.0	145.0	172.0	202.0	233.0	266.0	300.0	356.0	407.0	458.0	509.0
400	76.0	90.0	103.0	117.0	147.0	179.0	213.0	249.0	286.0	326.0	368.0	436.0	498.0	561.0	623.0
500	91.0	106.0	122.0	139.0	174.0	211.0	251.0	292.0	336.0	382.0	430.0	510.0	583.0	656.0	728.0
600	104.0	122.0	140.0	159.0	199.0	241.0	286.0	334.0	383.0	435.0	489.0	580.0	662.0	745.0	827.0
700	117.0	137.0	158.0	179.0	223.0	271.0	321.0	373.0	428.0	485.0	545.0	646.0	738.0	829.0	921.0
800	130.0	152.0	174.0	198.0	247.0	299.0	353.0	411.0	471.0	533.0	598.0	709.0	809.0	910.0	1010.0
900	142.0	166.0	191.0	216.0	269.0	326.0	385.0	447.0	512.0	580.0	650.0	769.0	879.0	987.0	1096.0
950	148.0	173.0	199.0	225.0	280.0	339.0	401.0	465.0	532.0	603.0	675.0	799.0	912.0	1025.0	1137.0
1000	154.0	180.0	206.0	234.0	291.0	352.0	416.0	483.0	552.0	625.0	699.0	828.0	945.0	1062.0	1178.0
1200	177.0	207.0	237.0	268.0	334.0	403.0	475.0	551.0	629.0	710.0	794.0	939.0	1072.0	1204.0	1334.0
1400	199.0	232.0	266.0	301.0	375.0	451.0	532.0	615.0	702.0	791.0	884.0	1044.0	1191.0	1336.0	1480.0
1450	205.0	239.0	274.0	309.0	384.0	463.0	545.0	631.0	720.0	811.0	905.0	1070.0	1220.0	1368.0	1515.0
1600	221.0	257.0	295.0	333.0	414.0	498.0	586.0	677.0	771.0	869.0	969.0	1144.0	1303.0	1461.0	1617.0
1800	242.0	281.0	322.0	364.0	451.0	543.0	638.0	736.0	838.0	943.0	1050.0	1239.0	1410.0	1578.0	1745.0
2000	262.0	305.0	349.0	394.0	488.0	586.0	688.0	794.0	902.0	1014.0	1128.0	1329.0	1511.0	1689.0	1864.0
2400	301.0	350.0	400.0	451.0	558.0	669.0	784.0	902.0	1024.0	1148.0	1274.0	1497.0	1697.0	1891.0	2079.0
2850	338.0	393.0	449.0	506.0	625.0	748.0	874.0	1004.0	1137.0	1272.0	1408.0	1649.0	1863.0	2067.0	2262.0
3200	374.0	434.0	496.0	559.0	688.0	822.0	960.0	1100.0	1242.0	1386.0	1531.0	1786.0	2008.0	2217.0	2411.0
3600	409.0	474.0	541.0	609.0	749.0	893.0	1040.0	1190.0	1340.0	1492.0	1644.0	1908.0	2134.0	2340.0	2526.0
4000	443.0	513.0	585.0	658.0	808.0	961.0	1116.0	1274.0	1431.0	1589.0	1745.0	2015.0	2238.0	2436.0	2604.0
5000	523.0	605.0	688.0	772.0	943.0	1115.0	1288.0	1459.0	1628.0	1792.0	1951.0	2212.0	2402.0	2541.0	2623.0
6000	598.0	690.0	783.0	877.0	1064.0	1250.0	1433.0	1610.0	1778.0	1937.0	2084.0	2301.0	2411.0	2434.0	2358.0
7000	669.0	769.0	870.0	971.0	1171.0	1365.0	1550.0	1722.0	1880.0	2019.0	2137.0	2268.0	2245.0		
8000	735.0	843.0	950.0	1057.0	1264.0	1459.0	1637.0	1794.0	1927.0	2031.0	2101.0	2100.0			
10000	854.0	972.0	1088.0	1199.0	1403.0	1577.0	1714.0	1804.0	1842.0	1819.0	1729.0				
12000	956.0	1078.0	1193.0	1299.0	1476.0	1594.0	1643.0	1609.0							
14000	1039.0	1158.0	1264.0	1354.0	1473.0	1495.0	1403.0								

Power ratings for other belt widths can be calculated by multiplying by the width correction factors.

Width correction factor							
Profile and design 5M							
Belt width [mm]	6	Standard 9	12	Standard 15	20	Standard 25	30
Factor	0.61	1.00	1.44	1.87	2.63	3.40	4.15

POWER RATINGS

optibelt **OMEGA** TIMING BELTS

PROFILE AND DESIGN 8M



Table 23

Nominal power P_N [kW] for profile and design 8M and a timing belt width of 20 mm																	
Speed of the small pulley n_k [min ⁻¹]	Number of teeth on the small pulley z_k																
	22	24	26	28	30	32	34	36	38	40	44	48	52	56	64	72	80
	Pitch diameter of the small pulley d_{wk} [mm]																
	56.02	61.12	66.21	71.30	76.39	81.49	86.58	91.67	96.77	101.86	112.05	122.23	132.42	142.60	162.97	183.35	203.72
10	0.015	0.018	0.022	0.026	0.029	0.036	0.042	0.046	0.053	0.057	0.061	0.068	0.072	0.078	0.087	0.097	0.106
20	0.033	0.037	0.044	0.051	0.062	0.072	0.082	0.093	0.106	0.114	0.125	0.135	0.144	0.154	0.173	0.194	0.213
50	0.081	0.092	0.110	0.132	0.154	0.179	0.207	0.234	0.262	0.283	0.310	0.336	0.361	0.386	0.435	0.483	0.532
100	0.165	0.183	0.223	0.264	0.311	0.359	0.412	0.466	0.526	0.566	0.621	0.671	0.722	0.770	0.870	0.967	1.064
200	0.326	0.370	0.447	0.531	0.623	0.720	0.823	0.933	1.051	1.131	1.239	1.340	1.442	1.541	1.739	1.933	2.125
300	0.491	0.535	0.645	0.766	0.897	1.040	1.190	1.340	1.510	1.640	1.780	1.930	2.070	2.220	2.500	2.770	3.050
400	0.652	0.711	0.839	0.993	1.165	1.340	1.540	1.740	1.960	2.120	2.310	2.500	2.680	2.870	3.230	3.590	3.940
500	0.810	0.890	1.020	1.220	1.420	1.640	1.880	2.130	2.390	2.590	2.820	3.050	3.270	3.500	3.940	4.370	4.800
600	0.980	1.070	1.210	1.430	1.670	1.930	2.210	2.510	2.820	3.050	3.320	3.590	3.850	4.110	4.630	5.130	5.630
700	1.140	1.240	1.380	1.640	1.920	2.220	2.540	2.880	3.230	3.500	3.810	4.110	4.410	4.710	5.300	5.870	6.440
800	1.300	1.420	1.560	1.850	2.170	2.500	2.860	3.240	3.640	3.940	4.280	4.630	4.970	5.300	5.960	6.600	7.230
950	1.550	1.690	1.830	2.160	2.520	2.910	3.330	3.770	4.240	4.580	4.990	5.380	5.770	6.160	6.910	7.650	8.370
1000	1.630	1.770	1.930	2.260	2.640	3.050	3.480	3.950	4.440	4.800	5.220	5.630	6.040	6.440	7.230	7.990	8.740
1200	1.950	2.130	2.310	2.650	3.100	3.580	4.090	4.630	5.210	5.630	6.120	6.600	7.070	7.540	8.440	9.320	10.170
1450	2.350	2.570	2.790	3.130	3.660	4.230	4.830	5.470	6.140	6.640	7.210	7.770	8.310	8.850	9.890	10.900	11.850
1600	2.590	2.830	3.070	3.420	3.990	4.610	5.260	5.960	6.690	7.230	7.840	8.440	9.030	9.610	10.730	11.790	12.800
1800	2.920	3.180	3.450	3.780	4.420	5.100	5.820	6.590	7.400	7.990	8.670	9.320	9.960	10.590	11.790	12.920	13.990
2000	3.230	3.520	3.820	4.180	4.840	5.580	6.370	7.210	8.090	8.740	9.470	10.170	10.860	11.530	12.800	13.990	15.090
2200	3.550	3.870	4.190	4.590	5.250	6.050	6.910	7.820	8.770	9.470	10.240	11.000	11.730	12.430	13.760	14.980	16.090
2500	4.020	4.380	4.750	5.190	5.840	6.740	7.690	8.690	9.750	10.520	11.360	12.180	12.950	13.700	15.090	16.320	17.400
2850	4.570	4.970	5.380	5.880	6.510	7.510	8.560	9.670	10.850	11.690	12.600	13.470	14.290	15.060	16.460	17.650	18.620
3000	4.800	5.220	5.650	6.170	6.790	7.820	8.920	10.080	11.300	12.180	13.110	13.990	14.820	15.600	16.990	18.140	19.040
3500					7.720	8.840	10.070	11.370	12.730	13.700	14.680	15.600	16.440	17.200	18.470	19.380	19.890
4000						9.780	11.130	12.550	14.040	15.090	16.090	16.990	17.790	18.470			
4500							12.090	13.620	15.230	16.320	17.300	18.140	18.840				
5000								14.580	16.270	17.400	18.310	19.040	19.570				
5500									17.170	18.310	19.100						
6000										17.910	19.040	19.650					

Power ratings for other belt widths can be calculated by multiplying by the width correction factors.

Width correction factor				
Profile and design 8M				
Standard belt width [mm]	20	30	50	85
Factor	1.00	1.58	2.73	4.74

POWER RATINGS

optibelt **OMEGA** TIMING BELTS

PROFILE AND DESIGN 14M



Table 24

Nominal power P_N [kW] for profile and design 14M and a timing belt width of 40 mm																	
Speed of the small pulley n_k [min ⁻¹]	Number of teeth on the small pulley z_k																
	28	29	30	32	34	36	38	40	42	44	46	48	52	56	64	72	80
	Pitch diameter of the small pulley d_{wk} [mm]																
	124.78	129.23	133.69	142.60	151.52	160.43	169.34	178.25	187.17	196.08	204.99	213.90	231.73	249.55	285.21	320.86	356.51
10	0.17	0.20	0.20	0.23	0.29	0.30	0.34	0.36	0.38	0.40	0.42	0.44	0.49	0.53	0.61	0.68	0.74
20	0.35	0.37	0.43	0.49	0.55	0.63	0.68	0.72	0.76	0.80	0.83	0.89	0.97	1.04	1.19	1.34	1.50
40	0.72	0.78	0.84	0.98	1.10	1.25	1.34	1.42	1.52	1.59	1.69	1.76	1.93	2.10	2.39	2.69	2.99
60	1.07	1.15	1.27	1.44	1.64	1.88	2.03	2.14	2.27	2.39	2.52	2.65	2.90	3.14	3.58	4.03	4.49
100	1.79	1.93	2.10	2.42	2.77	3.11	3.37	3.58	3.79	4.00	4.20	4.41	4.85	5.23	5.98	6.72	7.48
200	3.60	3.90	4.20	4.80	5.50	6.20	6.80	7.20	7.60	8.00	8.40	8.90	9.70	10.50	12.00	13.50	15.00
300	4.90	5.30	5.70	6.60	7.50	8.50	9.20	9.70	10.30	10.80	11.40	12.00	13.10	14.20	16.50	18.90	21.30
400	6.10	6.60	7.10	8.20	9.30	10.50	11.40	12.00	12.70	13.30	14.00	14.70	16.10	17.40	20.10	22.90	25.80
500	7.20	7.80	8.40	9.60	11.00	12.30	13.30	14.10	14.80	15.60	16.40	17.20	18.70	20.20	23.30	26.40	29.60
600	8.20	8.90	9.50	11.00	12.50	14.00	15.10	15.90	16.80	17.70	18.50	19.40	21.10	22.70	26.10	29.50	32.90
700	9.10	9.90	10.60	12.20	13.90	15.60	16.80	17.70	18.60	19.50	20.50	21.40	23.20	25.00	28.60	32.20	35.80
800	10.00	10.80	11.60	13.40	15.10	17.00	18.30	19.30	20.30	21.30	22.20	23.20	25.20	27.00	30.80	34.50	38.20
950	11.30	12.10	13.10	14.90	16.90	19.00	20.40	21.40	22.50	23.60	24.60	25.70	27.70	29.70	33.60	37.40	41.10
1000	11.60	12.60	13.50	15.40	17.50	19.60	21.00	22.10	23.20	24.30	25.40	26.50	28.50	30.50	34.40	38.20	41.90
1200	13.10	14.10	15.10	17.30	19.50	21.80	23.40	24.50	25.70	26.80	28.00	29.10	31.20	33.20	37.10	40.70	44.10
1450	14.60	15.70	16.90	19.20	21.70	24.20	25.90	27.10	28.30	29.40	30.60	31.70	33.80	35.70	39.20	42.30	44.80
1600	15.40	16.60	17.80	20.30	22.80	25.50	27.10	28.30	29.50	30.70	31.80	32.90	34.90	36.60	39.80	42.30	44.10
1800	16.40	17.70	18.90	21.50	24.10	26.80	28.50	29.70	30.90	32.00	33.00	34.00	35.80	37.30	39.80	41.30	43.00
2000	17.30	18.60	19.80	22.50	25.20	28.00	29.70	30.80	31.90	32.90	33.80	34.70	36.20	37.40	38.90		
2200	18.60	19.30	20.60	23.30	26.10	28.90	30.50	31.50	32.50	33.40	34.20	35.00	36.10	36.70			
2400	20.10	20.70	21.30	24.00	26.70	29.50	31.10	32.00	32.80	33.50	34.20	34.70	35.30	35.40			
2600	21.50	22.10	22.70	24.40	27.20	29.90	31.40	32.10	32.70	33.20	33.70	33.90	34.00				
2850	23.10	23.80	24.40	25.60	27.40	30.00	31.30	31.80	32.10	32.30	32.40	32.30	31.70				
3000	24.10	24.70	25.30	26.50	27.50	30.10	31.00	31.60	31.50	31.50	31.40	31.60					
3500			28.00	29.10	30.00	30.70	31.20	31.50	31.70								
4000				30.80	31.40												

Power ratings for other belt widths can be calculated by multiplying by the width correction factors.

Width correction factor					
Profile and design 14M					
Standard belt width [mm]	40	55	85	115	170
Factor	1.00	1.50	2.50	3.47	5.28



optibelt **OMEGA HL**



OPTIBELT OMEGA HP



OPTIBELT OMEGA



OPTIBELT OMEGA FAN POWER



OPTIBELT OMEGA LINEAR
OPTIBELT OMEGA HP LINEAR



OPTIBELT OMEGA
double-sided



OPTIBELT ZR



OPTIBELT ZR LINEAR



OPTIBELT STD®

POWER RATINGS

optibelt ZR PROFILE MXL

NOMINAL POWER P_N [W] AT THE BELT WIDTH OF 1" \approx 25,4 MM



Table 25

Number of teeth of the small timing belt pulley	10 MXL	12 MXL	14 MXL	15 MXL	16 MXL	18 MXL	20 MXL	22 MXL	24 MXL	28 MXL
Pitch diameter [mm]	6.47	7.76	9.06	9.70	10.35	11.64	12.94	14.23	15.52	18.11
Rotary frequency of the small timing belt pulley [min ⁻¹]										
10	0.62	0.62	0.74	0.87	0.87	0.99	1.12	1.24	1.36	1.61
40	2.23	2.73	3.10	3.35	3.60	4.09	4.46	4.96	5.33	6.32
60	3.35	4.09	4.71	5.08	5.33	6.08	6.70	7.44	8.06	9.42
100	5.58	6.70	7.81	8.43	8.93	10.04	11.16	12.28	13.39	15.75
200	11.16	13.39	15.75	16.86	17.98	20.21	22.44	24.68	26.91	31.37
400	14.64	26.91	31.37	33.60	35.84	40.30	44.89	49.35	53.82	62.74
600	33.60	40.30	47.12	50.47	54.93	60.51	67.21	74.03	80.72	94.12
800	44.89	53.82	62.74	67.33	71.67	80.72	89.65	98.58	107.63	125.49
1000	56.05	67.21	78.49	84.07	89.65	100.81	112.10	123.26	134.54	156.86
1200	67.21	80.72	94.24	100.94	107.63	121.02	134.54	147.93	161.45	188.23
1400	78.49	94.12	109.86	117.30	125.49	141.24	156.86	172.61	188.23	219.73
1600	89.65	107.63	125.24	135.16	143.47	161.45	172.10	197.28	215.14	251.10
1800	100.81	121.02	141.36	151.28	161.45	181.54	201.75	221.96	242.05	282.47
2000	112.10	134.54	157.48	168.64	179.30	201.75	224.19	246.51	268.96	313.84
2400	134.54	161.45	188.48	202.12	215.14	242.05	268.96	295.86	322.77	376.59
2800	156.86	188.23	219.48	235.60	251.10	282.47	313.84	345.22	376.59	439.33
3200	179.30	215.14	251.72	269.08	286.94	322.77	358.61	394.44	430.40	502.08
3600	201.75	242.05	282.72	302.56	322.77	363.07	403.50	443.80	484.22	564.82
4000	224.19	268.96	313.72	336.04	358.61	403.50	448.26	493.15	537.91	627.56
5000	280.24	336.29	391.84	420.36	448.26	504.31	560.36	616.40	672.45	784.55
6000	336.29	403.50	471.20	504.68	537.91	605.24	672.45	739.66	806.99	941.41
8000	448.26	537.91	627.44	673.32	729.74	806.99	896.64	986.30	1075.95	1255.25
10000	560.36	672.45	784.92	840.72	896.64	1008.74	1120.71	1232.81	1344.90	1569.10
12000	672.45	806.99	942.40	1009.36	1075.95	1210.36	1344.90	1479.44	1613.86	1882.82
14000	784.55	941.41	1098.64	1176.76	1255.25	1412.11	1569.10	1725.96	1882.82	2196.66

Width correction factor

Profile and design MXL

Belt code	012	019	025	031	037	043	0.50	063	075
Belt width [mm]	3.18	4.76	6.35	7.94	9.53	11.11	12.70	15.88	19.05
Factor	0.06	0.12	0.18	0.24	0.30	0.36	0.42	0.57	0.71

POWER RATINGS

optibelt ZR PROFILE MXL



NOMINAL POWER P_N [W] AT THE BELT WIDTH OF 1" \approx 25,4 MM

Table 26

30 MXL	32 MXL	36 MXL	40 MXL	42 MXL	48 MXL	60 MXL	72 MXL	80 MXL	Number of teeth of the small timing belt pulley
19.40	20.70	23.29	25.87	27.17	31.05	38.81	46.57	51.74	Pitch diameter [mm]
1.74	1.74	1.98	2.23	2.36	2.73	3.35	4.09	4.46	10
6.70	7.19	8.06	8.93	9.42	10.79	13.39	16.12	17.98	40
10.04	10.79	12.15	13.39	14.14	16.12	20.21	24.18	26.91	60
16.86	17.98	20.21	22.44	23.56	26.91	33.60	40.30	44.89	100
33.60	35.84	40.30	44.89	47.12	53.82	67.21	80.72	89.65	200
67.21	71.67	80.72	89.65	94.12	107.63	134.54	161.45	179.30	400
100.81	107.63	121.02	134.54	141.24	161.45	201.75	242.05	268.96	600
134.54	143.47	161.45	179.30	188.23	215.14	268.96	322.77	358.61	800
168.14	179.30	201.75	224.19	235.35	268.96	336.29	403.50	448.26	1000
201.75	215.14	242.05	268.96	282.47	322.77	403.50	484.22	537.91	1200
235.35	251.10	282.47	313.84	329.47	376.59	470.70	564.82	627.56	1400
268.96	286.94	322.77	358.61	376.59	430.40	537.91	645.54	717.34	1600
302.56	322.77	363.07	403.50	423.58	484.22	605.24	726.27	806.99	1800
336.29	358.61	403.50	448.26	470.70	537.91	672.45	806.99	896.64	2000
403.50	430.40	484.22	537.91	564.82	645.54	806.99	968.32	1075.95	2400
470.70	502.08	564.82	621.98	659.06	753.18	941.41	1129.76	1255.25	2800
537.91	573.87	645.54	717.34	753.18	860.68	1075.95	1291.09	1434.56	3200
605.24	645.54	726.27	806.99	847.29	968.32	1210.36	1452.54	1613.86	3600
672.45	717.34	806.99	896.64	941.41	1075.95	1344.90	1613.86	1793.16	4000
840.60	896.64	1008.74	1120.71	1176.76	1344.90	1681.19	2017.36	2241.55	5000
1008.74	1075.95	1210.36	1344.90	1412.11	1613.86	2017.36	2420.85	2689.81	6000
1344.90	1434.56	1613.86	1793.16	1882.82	2151.90	2689.81	3227.72	3586.45	8000
1681.19	1793.16	2017.36	2241.55	2353.64	2689.81	3362.26	4034.71	4482.97	10000
2017.36	2151.90	2420.85	2689.81	2824.35	3227.72	4034.71	4841.70	5379.62	12000
2353.64	2510.50	2824.35	3138.07	3295.05	3765.76	4707.16	5648.57	6276.26	14000

Rotary frequency of the small timing belt pulley [min⁻¹]

Width correction factor									
Profile and design MXL									
Belt code	012	019	025	031	037	043	0.50	063	075
Belt width [mm]	3.18	4.76	6.35	7.94	9.53	11.11	12.70	15.88	19.05
Factor	0.06	0.12	0.18	0.24	0.30	0.36	0.42	0.57	0.71

POWER RATINGS

optibelt ZR PROFILE XL

NOMINAL POWER P_N [KW] AT THE BELT WIDTH OF 1" \approx 25,4 MM



Table 27

Number of teeth of the small timing belt pulley	10 XL	11 XL	12 XL	13 XL	14 XL	15 XL	16 XL	17 XL	18 XL	19 XL	20 XL
Pitch diameter [mm]	16.17	17.79	19.40	21.02	22.64	24.26	25.87	27.49	29.11	30.72	32.34
100	0.01	0.01	0.01	0.02	0.02	0.02	0.02	0.03	0.03	0.03	0.03
200	0.03	0.03	0.04	0.04	0.04	0.04	0.05	0.05	0.05	0.06	0.06
300	0.04	0.05	0.05	0.06	0.07	0.07	0.07	0.08	0.08	0.09	0.09
400	0.06	0.07	0.07	0.08	0.08	0.09	0.10	0.10	0.10	0.11	0.12
500	0.07	0.08	0.09	0.10	0.10	0.11	0.12	0.13	0.13	0.14	0.15
600	0.09	0.10	0.10	0.12	0.13	0.13	0.14	0.15	0.16	0.17	0.18
700	0.10	0.11	0.13	0.14	0.15	0.16	0.17	0.18	0.19	0.20	0.21
800	0.12	0.13	0.14	0.16	0.17	0.18	0.19	0.21	0.22	0.24	0.25
900	0.13	0.15	0.16	0.18	0.19	0.20	0.22	0.24	0.25	0.27	0.28
1000	0.15	0.16	0.18	0.20	0.22	0.23	0.25	0.27	0.28	0.30	0.31
1100	0.16	0.19	0.19	0.21	0.23	0.25	0.27	0.29	0.30	0.32	0.34
1200	0.18	0.20	0.22	0.24	0.25	0.28	0.29	0.31	0.33	0.35	0.37
1300	0.19	0.22	0.23	0.26	0.28	0.30	0.31	0.34	0.36	0.38	0.40
1400	0.21	0.23	0.25	0.28	0.30	0.32	0.34	0.37	0.39	0.41	0.43
1500	0.22	0.25	0.27	0.30	0.32	0.34	0.37	0.39	0.41	0.44	0.46
1600	0.25	0.27	0.30	0.32	0.34	0.37	0.40	0.42	0.44	0.46	0.48
1800	0.28	0.30	0.33	0.36	0.38	0.41	0.44	0.47	0.49	0.52	0.55
2000	0.31	0.34	0.37	0.40	0.43	0.46	0.48	0.52	0.55	0.58	0.61
2200	0.34	0.37	0.40	0.44	0.47	0.51	0.54	0.57	0.60	0.64	0.67
2400	0.37	0.40	0.44	0.48	0.51	0.55	0.59	0.63	0.66	0.70	0.73
2600	0.40	0.43	0.48	0.52	0.55	0.60	0.63	0.68	0.72	0.76	0.79
2800	0.43	0.47	0.51	0.56	0.60	0.64	0.69	0.73	0.77	0.82	0.86
3000	0.46	0.50	0.55	0.60	0.64	0.69	0.73	0.78	0.82	0.87	0.92
3200	0.48	0.54	0.59	0.64	0.68	0.73	0.78	0.83	0.88	0.93	0.97
3400	0.51	0.57	0.62	0.67	0.72	0.78	0.83	0.88	0.93	0.98	1.03
3600	0.55	0.60	0.66	0.72	0.77	0.82	0.88	0.93	0.98	1.04	1.09
3800	0.58	0.62	0.69	0.75	0.81	0.87	0.93	0.99	1.04	1.10	1.15
4000	0.61	0.67	0.73	0.80	0.86	0.92	0.97	1.03	1.09	1.16	1.22
4200	0.64	0.70	0.77	0.84	0.90	0.95	1.02	1.08	1.14	1.21	1.28
4400	0.67	0.74	0.81	0.87	0.93	1.00	1.07	1.14	1.20	1.27	1.33
4600	0.70	0.77	0.84	0.91	0.98	1.04	1.12	1.19	1.25	1.32	1.39
4800	0.73	0.80	0.88	0.95	1.02	1.09	1.16	1.24	1.31	1.38	1.45
5000	0.76	0.84	0.92	0.99	1.06	1.13	1.22	1.29	1.36	1.43	1.50
5500	0.86	0.93	1.01	1.09	1.18	1.25	1.33	1.41	1.49	1.57	1.64
6000	0.93	1.01	1.10	1.19	1.29	1.36	1.45	1.53	1.61	1.70	1.78
6500	1.01	1.10	1.20	1.29	1.38	1.46	1.56	1.66	1.75	1.84	1.92
7000	1.08	1.18	1.29	1.39	1.49	1.57	1.67	1.77	1.86	1.96	2.05
7500	1.16	1.27	1.37	1.47	1.58	1.68	1.78	1.88	1.98	2.08	2.18
8000	1.23	1.34	1.46	1.57	1.68	1.78	1.88	1.98	2.10	2.21	2.31
8500	1.30	1.42	1.54	1.65	1.77	1.88	2.00	2.10	2.22	2.33	2.43
9000	1.37	1.50	1.63	1.75	1.87	1.98	2.10	2.21	2.33	2.44	2.54
9500	1.44	1.57	1.71	1.83	1.96	2.08	2.20	2.32	2.45	2.56	2.66
10000	1.52	1.65	1.79	1.92	2.05	2.18	2.30	2.42	2.54	2.66	2.77

When using this timing belt pulley the operational life will be reduced.

Width correction factor										
Profile and design XL										
Belt code	019	025	031	037	043	0.50	063	075	100	
Belt width [mm]	4.76	6.35	7.94	9.53	11.11	12.70	15.88	19.05	25.40	
Factor	0.12	0.18	0.24	0.30	0.36	0.42	0.57	0.71	1.00	

POWER RATINGS

optibelt **ZR** PROFILE XL

NOMINAL POWER P_N [KW] AT THE BELT WIDTH OF 1" \approx 25,4 MM



Table 28

21 XL	22 XL	23 XL	24 XL	25 XL	26 XL	27 XL	28 XL	29 XL	30 XL	Number of teeth of the small timing belt pulley
33.96	35.57	37.19	38.81	40.43	42.04	43.67	45.28	46.89	48.51	Pitch diameter [mm]
0.03	0.03	0.04	0.04	0.04	0.04	0.04	0.04	0.04	0.04	100
0.06	0.07	0.07	0.07	0.07	0.08	0.08	0.08	0.09	0.09	200
0.10	0.10	0.10	0.10	0.11	0.12	0.13	0.13	0.13	0.13	300
0.13	0.13	0.14	0.14	0.15	0.16	0.17	0.17	0.18	0.18	400
0.16	0.16	0.17	0.18	0.19	0.20	0.21	0.22	0.22	0.22	500
0.19	0.20	0.21	0.22	0.23	0.24	0.25	0.25	0.27	0.28	600
0.22	0.23	0.24	0.25	0.27	0.28	0.29	0.30	0.31	0.32	700
0.25	0.27	0.29	0.30	0.31	0.32	0.33	0.34	0.36	0.37	800
0.29	0.30	0.32	0.33	0.35	0.36	0.37	0.38	0.40	0.41	900
0.32	0.34	0.36	0.37	0.39	0.40	0.42	0.43	0.45	0.46	1000
0.35	0.37	0.39	0.40	0.42	0.44	0.46	0.47	0.49	0.51	1100
0.39	0.40	0.42	0.44	0.46	0.48	0.50	0.51	0.53	0.55	1200
0.42	0.43	0.46	0.48	0.50	0.52	0.54	0.55	0.58	0.60	1300
0.45	0.47	0.49	0.51	0.54	0.56	0.58	0.60	0.62	0.64	1400
0.48	0.50	0.53	0.55	0.58	0.60	0.62	0.64	0.67	0.69	1500
0.51	0.54	0.57	0.59	0.62	0.64	0.66	0.68	0.71	0.73	1600
0.57	0.60	0.63	0.66	0.69	0.71	0.74	0.77	0.80	0.82	1800
0.64	0.67	0.70	0.73	0.77	0.80	0.83	0.86	0.89	0.92	2000
0.70	0.74	0.78	0.81	0.84	0.87	0.90	0.93	0.97	1.00	2200
0.77	0.80	0.84	0.88	0.92	0.95	0.99	1.02	1.06	1.09	2400
0.84	0.87	0.90	0.93	0.98	1.02	1.06	1.10	1.14	1.18	2600
0.90	0.94	0.98	1.02	1.07	1.11	1.15	1.19	1.24	1.28	2800
0.95	1.00	1.05	1.09	1.14	1.19	1.24	1.28	1.32	1.36	3000
1.02	1.07	1.12	1.16	1.21	1.26	1.31	1.35	1.40	1.45	3200
1.08	1.13	1.19	1.24	1.29	1.34	1.39	1.43	1.48	1.53	3400
1.15	1.20	1.26	1.31	1.36	1.41	1.46	1.51	1.56	1.61	3600
1.21	1.27	1.32	1.37	1.43	1.48	1.54	1.59	1.64	1.69	3800
1.29	1.33	1.39	1.45	1.51	1.56	1.62	1.67	1.73	1.78	4000
1.33	1.39	1.45	1.51	1.57	1.63	1.69	1.75	1.81	1.86	4200
1.39	1.45	1.52	1.58	1.65	1.71	1.77	1.83	1.89	1.95	4400
1.45	1.52	1.59	1.65	1.72	1.78	1.84	1.90	1.96	2.02	4600
1.51	1.59	1.66	1.72	1.79	1.85	1.92	1.98	2.04	2.10	4800
1.57	1.64	1.71	1.78	1.85	1.92	1.99	2.05	2.12	2.18	5000
1.72	1.80	1.88	1.95	2.02	2.09	2.16	2.23	2.30	2.37	5500
1.86	1.95	2.03	2.10	2.18	2.26	2.34	2.41	2.48	2.54	6000
2.01	2.09	2.18	2.26	2.34	2.41	2.48	2.55	2.64	2.72	6500
2.14	2.23	2.32	2.41	2.49	2.57	2.65	2.72	2.79	2.86	7000
2.28	2.37	2.46	2.54	2.62	2.70	2.78	2.86	2.94	3.01	7500
2.41	2.49	2.59	2.68	2.76	2.84	2.92	3.00	3.07	3.14	8000
2.53	2.63	2.72	2.80	2.89	2.97	3.05	3.13	3.20	3.26	8500
2.65	2.75	2.84	2.92	3.00	3.08	3.16	3.24	3.30	3.36	9000
2.76	2.86	2.95	3.04	3.12	3.19	3.26	3.33	3.39	3.45	9500
2.86	2.96	3.05	3.14	3.21	3.28	3.35	3.42	3.47	3.52	10000

Rotary frequency of the small timing belt pulley [min⁻¹]

Width correction factor										
Profile and design XL										
Belt code	019	025	031	037	043	0.50	063	075	100	
Belt width [mm]	4.76	6.35	7.94	9.53	11.11	12.70	15.88	19.05	25.40	
Factor	0.12	0.18	0.24	0.30	0.36	0.42	0.57	0.71	1.00	

POWER RATINGS

optibelt ZR PROFILE L

NOMINAL POWER P_N [KW] AT THE BELT WIDTH OF 1" \approx 25,4 MM



Table 29

Number of teeth of the small timing belt pulley	10 L	11 L	12 L	13 L	14 L	15 L	16 L	17 L	18 L	19 L	20 L	21 L	22 L	23 L	24 L	25 L	26 L	27 L	28 L	29 L
Pitch diameter [mm]	30.32 33.35 36.38 39.41 42.45 45.48 48.51 51.54 54.57 57.61 60.64 63.67 66.70 69.73 72.77 75.80 78.83 81.86 84.89 87.93																			
100	0.04	0.04	0.04	0.05	0.05	0.06	0.06	0.07	0.07	0.07	0.07	0.08	0.09	0.10	0.10	0.10	0.10	0.11	0.11	0.12
200	0.07	0.09	0.10	0.10	0.11	0.12	0.13	0.13	0.14	0.15	0.16	0.16	0.17	0.18	0.19	0.20	0.20	0.21	0.22	0.23
300	0.12	0.13	0.14	0.15	0.16	0.17	0.19	0.20	0.21	0.22	0.23	0.25	0.25	0.27	0.28	0.30	0.31	0.32	0.33	0.34
400	0.16	0.18	0.19	0.20	0.22	0.23	0.25	0.26	0.28	0.30	0.31	0.33	0.34	0.36	0.37	0.39	0.40	0.42	0.43	0.45
500	0.19	0.21	0.23	0.25	0.28	0.29	0.31	0.33	0.35	0.37	0.39	0.41	0.43	0.45	0.47	0.49	0.51	0.53	0.54	0.56
600	0.23	0.26	0.28	0.31	0.33	0.35	0.37	0.40	0.42	0.44	0.47	0.49	0.51	0.54	0.56	0.58	0.60	0.63	0.65	0.68
700	0.28	0.31	0.33	0.35	0.38	0.41	0.43	0.46	0.49	0.51	0.54	0.57	0.60	0.63	0.65	0.68	0.71	0.74	0.76	0.79
800	0.31	0.34	0.37	0.40	0.43	0.46	0.50	0.53	0.56	0.59	0.62	0.65	0.69	0.72	0.75	0.78	0.81	0.84	0.87	0.90
900	0.35	0.39	0.42	0.46	0.49	0.52	0.56	0.60	0.63	0.66	0.70	0.73	0.77	0.81	0.84	0.87	0.90	0.94	0.97	1.01
1000	0.39	0.43	0.46	0.51	0.54	0.58	0.62	0.66	0.70	0.74	0.78	0.81	0.85	0.89	0.93	0.97	1.00	1.04	1.08	1.12
1100	0.43	0.47	0.51	0.56	0.60	0.64	0.69	0.72	0.77	0.81	0.85	0.90	0.93	0.97	1.01	1.06	1.10	1.15	1.19	1.23
1200	0.47	0.52	0.56	0.60	0.66	0.70	0.75	0.79	0.84	0.88	0.93	0.97	1.01	1.06	1.11	1.16	1.20	1.25	1.29	1.34
1300	0.51	0.56	0.60	0.66	0.71	0.75	0.81	0.86	0.90	0.95	1.00	1.05	1.10	1.15	1.20	1.25	1.30	1.35	1.40	1.45
1400	0.54	0.60	0.65	0.71	0.76	0.81	0.87	0.92	0.97	1.03	1.08	1.13	1.19	1.24	1.29	1.35	1.40	1.45	1.50	1.55
1500	0.58	0.64	0.70	0.76	0.81	0.87	0.93	0.98	1.04	1.10	1.16	1.21	1.27	1.33	1.38	1.44	1.49	1.55	1.60	1.66
1600	0.62	0.69	0.75	0.81	0.87	0.93	0.98	1.05	1.11	1.17	1.23	1.29	1.35	1.41	1.47	1.53	1.59	1.65	1.70	1.76
1700	0.66	0.73	0.79	0.86	0.92	0.98	1.05	1.11	1.18	1.24	1.31	1.37	1.43	1.50	1.56	1.63	1.69	1.75	1.81	1.87
1800	0.70	0.77	0.84	0.90	0.97	1.04	1.11	1.18	1.25	1.31	1.38	1.45	1.51	1.58	1.65	1.72	1.78	1.85	1.91	1.98
1900	0.74	0.81	0.88	0.95	1.03	1.10	1.17	1.24	1.31	1.38	1.45	1.52	1.60	1.68	1.73	1.80	1.87	1.94	2.01	2.08
2000	0.77	0.86	0.93	1.01	1.08	1.16	1.23	1.31	1.38	1.45	1.53	1.60	1.68	1.75	1.82	1.89	1.96	2.03	2.10	2.18
2200	0.86	0.94	1.01	1.10	1.19	1.27	1.35	1.43	1.51	1.60	1.68	1.75	1.84	1.92	1.99	2.07	2.15	2.23	2.30	2.38
2400	0.93	1.01	1.11	1.20	1.29	1.38	1.47	1.56	1.65	1.73	1.82	1.91	1.99	2.08	2.16	2.25	2.33	2.41	2.49	2.58
2500	0.97	1.06	1.16	1.25	1.34	1.43	1.53	1.62	1.72	1.81	1.89	1.98	2.07	2.16	2.25	2.34	2.42	2.51	2.59	2.67
2600	1.00	1.11	1.20	1.30	1.40	1.49	1.59	1.69	1.78	1.87	1.96	2.06	2.15	2.24	2.33	2.42	2.51	2.60	2.68	2.76
2800	1.08	1.18	1.29	1.40	1.50	1.60	1.71	1.81	1.91	2.01	2.10	2.21	2.31	2.40	2.49	2.59	2.68	2.77	2.86	2.95
3000	1.17	1.28	1.38	1.49	1.60	1.71	1.82	1.93	2.04	2.14	2.25	2.35	2.45	2.55	2.65	2.75	2.84	2.94	3.03	3.12
3200	1.24	1.36	1.47	1.59	1.70	1.82	1.94	2.04	2.16	2.27	2.38	2.49	2.60	2.70	2.80	2.91	3.01	3.11	3.20	3.30
3400	1.31	1.44	1.56	1.69	1.81	1.92	2.05	2.17	2.29	2.40	2.51	2.63	2.74	2.85	2.96	3.06	3.16	3.26	3.36	3.46
3600	1.39	1.52	1.65	1.77	1.90	2.04	2.16	2.29	2.41	2.53	2.65	2.77	2.88	2.99	3.10	3.21	3.32	3.42	3.52	3.52
3800	1.46	1.60	1.73	1.87	2.01	2.13	2.26	2.40	2.54	2.66	2.78	2.90	3.02	3.14	3.25	3.36	3.46	3.56	3.66	3.76
4000	1.53	1.67	1.81	1.96	2.11	2.24	2.39	2.51	2.66	2.78	2.90	3.03	3.16	3.28	3.39	3.50	3.60	3.70	3.80	3.89
4200	1.61	1.75	1.90	2.05	2.21	2.35	2.49	2.63	2.78	2.89	3.03	3.16	3.28	3.40	3.52	3.63	3.74	3.84	3.94	4.03
4400	1.67	1.83	1.98	2.14	2.30	2.45	2.60	2.74	2.88	3.01	3.15	3.28	3.41	3.53	3.65	3.76	3.87	3.97	4.06	4.15
4600	1.76	1.92	2.07	2.23	2.40	2.54	2.71	2.85	2.99	3.13	3.27	3.40	3.53	3.65	3.77	3.88	3.98	4.08	4.17	4.26
4800	1.83	1.99	2.15	2.32	2.49	2.64	2.81	2.95	3.11	3.25	3.39	3.52	3.65	3.77	3.88	3.99	4.09	4.18	4.27	4.35
5000	1.91	2.08	2.24	2.41	2.58	2.74	2.92	3.06	3.22	3.36	3.49	3.63	3.76	3.88	3.99	4.10	4.20	4.29	4.37	4.45
5200	1.98	2.16	2.33	2.50	2.67	2.84	3.01	3.16	3.32	3.45	3.60	3.74	3.86	3.98	4.09	4.20	4.30	4.38	4.46	4.53
5400	2.05	2.24	2.41	2.59	2.77	2.93	3.11	3.26	3.42	3.56	3.70	3.83	3.96	4.08	4.19	4.29	4.39	4.46	4.53	4.59
5600	2.13	2.31	2.49	2.67	2.85	3.02	3.20	3.36	3.52	3.66	3.80	3.94	4.06	4.17	4.27	4.37	4.46	4.53	4.60	4.64
5800	2.19	2.38	2.57	2.76	2.93	3.11	3.30	3.45	3.61	3.76	3.89	4.03	4.16	4.26	4.36	4.45	4.53	4.59	4.65	4.68
6000	2.26	2.46	2.65	2.84	3.02	3.20	3.39	3.54	3.71	3.84	3.98	4.12	4.24	4.33	4.42	4.51	4.59	4.64	4.68	4.71

When using this timing belt pulley the operational life will be reduced.

Width correction factor									
Profile and design L									
Belt code	025	031	037	043	0.50	063	075	100	125
Belt width [mm]	6.35	7.94	9.53	11.11	12.70	15.88	19.05	25.40	31.75
Factor	0.18	0.24	0.30	0.36	0.42	0.57	0.71	1.00	1.29

POWER RATINGS

optibelt ZR PROFILE L

NOMINAL POWER P_N [KW] AT THE BELT WIDTH OF 1" \approx 25,4 MM



Table 30

30 L	31 L	32 L	33 L	34 L	35 L	36 L	37 L	38 L	39 L	40 L	41 L	42 L	43 L	44 L	45 L	46 L	47 L	48 L	Number of teeth of the small timing belt pulley
90.96	93.99	97.02	100.05	103.08	106.12	109.15	112.18	115.21	118.24	121.28	124.31	127.34	130.37	133.40	136.44	139.47	142.50	145.53	Pitch diameter [mm]
0.12	0.13	0.13	0.13	0.14	0.14	0.14	0.15	0.15	0.16	0.16	0.16	0.17	0.17	0.17	0.17	0.18	0.19	0.19	100
0.23	0.24	0.25	0.26	0.27	0.28	0.28	0.29	0.30	0.31	0.31	0.32	0.33	0.34	0.34	0.35	0.36	0.37	0.37	200
0.35	0.36	0.37	0.39	0.40	0.41	0.42	0.44	0.45	0.46	0.47	0.48	0.49	0.50	0.51	0.53	0.54	0.55	0.56	300
0.46	0.48	0.50	0.52	0.53	0.55	0.56	0.58	0.59	0.61	0.62	0.64	0.66	0.68	0.69	0.71	0.72	0.74	0.75	400
0.58	0.60	0.62	0.64	0.66	0.68	0.70	0.72	0.74	0.76	0.78	0.80	0.82	0.84	0.85	0.85	0.89	0.91	0.93	500
0.70	0.73	0.75	0.78	0.80	0.82	0.84	0.86	0.89	0.91	0.93	0.95	0.97	0.99	1.01	1.04	1.06	10.9	1.11	600
0.81	0.84	0.87	0.90	0.92	0.95	0.97	1.00	1.03	1.06	1.08	1.11	1.14	1.17	1.19	1.22	1.24	1.27	1.29	700
0.93	0.96	0.98	1.02	1.05	1.08	1.11	1.14	1.17	1.20	1.23	1.26	1.29	1.32	1.35	1.38	1.41	1.44	1.47	800
1.04	1.08	1.11	1.14	1.18	1.22	1.25	1.29	1.32	1.35	1.38	1.42	1.45	1.48	1.51	1.55	1.58	1.62	1.65	900
1.16	1.20	1.23	1.27	1.31	1.35	1.38	1.42	1.46	1.50	1.53	1.57	1.61	1.65	1.68	1.72	1.75	1.79	1.82	1000
1.27	1.31	1.35	1.39	1.43	1.47	1.51	1.56	1.60	1.64	1.68	1.72	1.76	1.80	1.84	1.88	1.92	1.96	1.99	1100
1.38	1.43	1.47	1.42	1.56	1.61	1.65	1.70	1.74	1.78	1.82	1.87	1.91	1.95	1.99	2.04	2.08	2.12	2.16	1200
1.49	1.54	1.59	1.64	1.69	1.74	1.78	1.83	1.87	1.92	1.96	2.01	2.06	2.11	2.15	2.20	2.24	2.29	2.33	1300
1.60	1.66	1.71	1.76	1.81	1.86	1.91	1.96	2.01	2.06	2.10	2.16	2.21	2.26	2.31	2.36	2.40	2.45	2.49	1400
1.72	1.77	1.82	1.88	1.93	1.99	2.04	2.10	2.15	2.20	2.25	2.30	2.35	2.40	2.45	2.50	2.55	2.60	2.65	1500
1.82	1.88	1.94	2.00	2.05	2.11	2.16	2.22	2.28	2.34	2.39	2.45	2.50	2.55	2.60	2.65	2.70	2.75	2.80	1600
1.93	1.99	2.05	2.11	2.17	2.23	2.29	2.35	2.41	2.47	2.52	2.58	2.64	2.70	2.75	2.81	2.86	2.91	2.96	1700
2.04	2.10	2.16	2.23	2.29	2.35	2.41	2.47	2.53	2.59	2.65	2.71	2.77	2.83	2.88	2.94	2.99	3.05	3.10	1800
2.14	2.21	2.28	2.35	2.41	2.47	2.53	2.60	2.66	2.72	2.78	2.84	2.90	2.96	3.02	3.08	3.14	3.20	3.25	1900
2.25	2.32	2.38	2.45	2.52	2.59	2.66	2.72	2.78	2.84	2.90	2.97	3.03	3.10	3.16	3.22	3.28	3.34	3.39	2000
2.45	2.53	2.60	2.67	2.74	2.81	2.88	2.95	3.02	3.09	3.16	3.23	3.29	3.35	3.41	3.47	3.53	3.59	3.65	2200
2.66	2.73	2.80	2.88	2.96	3.04	3.11	3.18	3.25	3.32	3.39	3.46	3.52	3.59	3.65	3.71	3.77	3.83	3.89	2400
2.75	2.83	2.91	2.99	3.06	3.14	3.21	3.29	3.36	3.43	3.50	3.57	3.63	3.70	3.76	3.82	3.88	3.94	3.99	2500
2.84	2.93	3.01	3.09	3.16	3.24	3.31	3.39	3.46	3.53	3.60	3.67	3.73	3.80	3.86	3.92	3.98	4.04	4.09	2600
3.03	3.12	3.20	3.28	3.36	3.44	3.51	3.59	3.66	3.73	3.80	3.87	3.93	4.00	4.06	4.12	4.17	4.22	4.27	2800
3.21	3.30	3.39	3.47	3.55	3.63	3.71	3.78	3.85	3.92	3.99	4.06	4.12	4.18	4.24	4.29	4.34	4.39	4.43	3000
3.39	3.48	3.56	3.64	3.72	3.80	3.88	3.95	4.02	4.09	4.16	4.22	4.28	4.34	4.39	4.44	4.48	4.52	4.56	3200
3.55	3.64	3.72	3.80	3.88	3.96	4.04	4.11	4.18	4.25	4.31	4.36	4.41	4.46	4.51	4.55	4.58	4.65	4.65	3400
3.71	3.80	3.89	3.97	4.04	4.12	4.19	4.26	4.32	4.38	4.44	4.49	4.53	4.57	4.61	4.66	4.69	4.71	4.71	3600
3.85	3.94	4.03	4.11	4.18	4.25	4.32	4.38	4.43	4.49	4.54	4.58	4.61	4.65	4.68	4.72	4.74	4.75	4.72	3800
3.98	4.07	4.16	4.23	4.30	4.37	4.43	4.48	4.53	4.58	4.63	4.66	4.68	4.70	4.72	4.73	4.74	4.73	4.71	4000
4.12	4.20	4.28	4.35	4.41	4.48	4.54	4.58	4.61	4.65	4.68	4.70	4.71	4.73	4.74	4.75	4.74	4.72	4.65	4200
4.24	4.32	4.39	4.45	4.50	4.56	4.61	4.64	4.67	4.70	4.72	4.72	4.72	4.74	4.71	4.71	4.69	4.65	4.54	4400
4.34	4.41	4.48	4.53	4.58	4.63	4.67	4.69	4.71	4.73	4.74	4.74	4.71	4.70	4.65	4.64	4.59	4.53	4.39	4600
4.43	4.50	4.57	4.61	4.64	4.68	4.71	4.71	4.71	4.71	4.71	4.72	4.69	4.65	4.55	4.53	4.46	4.37	4.20	4800
4.52	4.58	4.63	4.66	4.70	4.72	4.73	4.77	4.73	4.71	4.67	4.66	4.62	4.56	4.42	4.38	4.28	4.15	3.95	5000
4.59	4.64	4.68	4.70	4.72	4.74	4.73	4.74	4.72	4.70	4.60	4.57	4.50	4.41	4.24	4.19	4.05	3.90	3.66	5200
4.65	4.68	4.71	4.75	4.75	4.75	4.70	4.72	4.67	4.60	4.48	4.45	4.35	4.23	4.04	3.96	3.80	3.61	3.31	5400
4.68	4.71	4.73	4.77	4.75	4.73	4.66	4.64	4.58	4.49	4.35	4.30	4.16	4.02	3.77	3.67	3.47	3.26	2.90	5600
4.71	4.72	4.73	4.75	4.73	4.68	4.58	4.55	4.46	4.36	4.18	4.10	3.94	3.76	3.48	3.35	3.11	2.85	2.44	5800
4.74	4.73	4.72	4.72	4.67	4.61	4.48	4.44	4.32	4.19	3.97	3.87	3.69	3.46	3.13	2.97	2.69	2.39	1.92	6000

Rotary frequency of the small timing belt pulley [min⁻¹]

Width correction factor									
Profile and design L									
Belt code	025	031	037	043	0.50	063	075	100	125
Belt width [mm]	6.35	7.94	9.53	11.11	12.70	15.88	19.05	25.40	31.75
Factor	0.18	0.24	0.30	0.36	0.42	0.57	0.71	1.00	1.29

POWER RATINGS

optibelt ZR PROFILE H

NOMINAL POWER P_N [KW] AT THE BELT WIDTH OF 1" \approx 25,4 MM



Table 31

Number of teeth of the small timing belt pulley	14 H	15 H	16 H	17 H	18 H	19 H	20 H	21 H	22 H	23 H	24 H	25 H	26 H	27 H	28 H	29 H	30 H	31 H
Pitch diameter [mm]	56.60	60.64	64.68	68.72	72.77	76.81	80.85	84.89	88.94	92.98	97.02	101.06	105.11	109.15	113.19	117.23	121.28	125.32
Rotary frequency of the small timing belt pulley [min ⁻¹]																		
100	0.19	0.20	0.21	0.22	0.24	0.25	0.26	0.28	0.29	0.30	0.31	0.33	0.34	0.36	0.37	0.39	0.40	0.42
200	0.37	0.40	0.43	0.45	0.48	0.50	0.53	0.55	0.58	0.61	0.63	0.66	0.69	0.72	0.74	0.77	0.79	0.82
300	0.55	0.59	0.63	0.67	0.72	0.75	0.79	0.83	0.87	0.91	0.95	0.99	1.03	1.07	1.11	1.15	1.19	1.23
400	0.74	0.79	0.84	0.90	0.95	1.00	1.05	1.11	1.16	1.22	1.27	1.32	1.37	1.43	1.48	1.53	1.58	1.64
500	0.93	0.99	1.05	1.12	1.19	1.25	1.32	1.39	1.45	1.52	1.58	1.65	1.72	1.78	1.84	1.91	1.98	2.04
600	1.11	1.19	1.27	1.34	1.42	1.51	1.58	1.66	1.74	1.82	1.89	1.97	2.05	2.13	2.21	2.29	2.36	2.44
700	1.29	1.39	1.48	1.57	1.66	1.75	1.84	1.93	2.03	2.12	2.21	2.30	2.39	2.48	2.57	2.67	2.76	2.85
800	1.48	1.59	1.69	1.79	1.89	2.00	2.10	2.21	2.31	2.42	2.52	2.63	2.73	2.84	2.94	3.05	3.15	3.26
900	1.66	1.78	1.89	2.01	2.13	2.25	2.36	2.48	2.60	2.72	2.83	2.95	3.07	3.19	3.30	3.42	3.54	3.66
1000	1.84	1.97	2.10	2.24	2.36	2.50	2.63	2.76	2.89	3.02	3.15	3.28	3.41	3.54	3.66	3.79	3.92	4.05
1100	2.03	2.17	2.31	2.46	2.60	2.75	2.89	3.03	3.18	3.32	3.46	3.60	3.74	3.89	4.03	4.17	4.30	4.45
1200	2.21	2.36	2.52	2.68	2.83	2.99	3.15	3.30	3.46	3.62	3.77	3.92	4.07	4.23	4.39	4.54	4.69	4.84
1300	2.40	2.56	2.73	2.90	3.07	3.24	3.41	3.57	3.74	3.91	4.07	4.24	4.41	4.58	4.74	4.91	5.07	5.23
1400	2.58	2.76	2.94	3.13	3.30	3.48	3.66	3.84	4.02	4.20	4.38	4.56	4.74	4.92	5.10	5.28	5.45	5.63
1500	2.77	2.96	3.15	3.34	3.54	3.73	3.92	4.11	4.30	4.48	4.68	4.88	5.07	5.26	5.45	5.64	5.82	6.01
1600	2.96	3.15	3.36	3.57	3.77	3.98	4.18	4.38	4.59	4.79	4.99	5.19	5.39	5.60	5.80	6.00	6.19	6.39
1700	3.14	3.34	3.56	3.78	4.00	4.21	4.43	4.65	4.86	5.08	5.30	5.51	5.72	5.93	6.14	6.35	6.56	6.77
1800	3.34	3.54	3.77	4.00	4.23	4.46	4.68	4.92	5.14	5.37	5.59	5.82	6.04	6.26	6.48	6.70	6.92	7.14
1900	3.52	3.78	4.04	4.22	4.46	4.70	4.94	5.18	5.42	5.66	5.89	6.13	6.36	6.60	6.83	7.06	7.28	7.51
2000	3.70	3.88	4.18	4.44	4.68	4.94	5.19	5.45	5.69	5.94	6.18	6.43	6.68	6.92	7.16	7.40	7.64	7.88
2100	3.89	4.13	4.39	4.55	4.92	5.18	5.44	5.71	5.97	6.23	6.48	6.74	6.99	7.25	7.50	7.75	7.99	8.23
2200	4.08	4.22	4.59	4.86	5.14	5.42	5.69	5.97	6.24	6.51	6.77	7.04	7.30	7.57	7.83	8.09	8.34	8.59
2300	4.26	4.51	4.80	5.09	5.37	5.65	5.94	6.22	6.51	6.79	7.06	7.34	7.62	7.89	8.15	8.42	8.68	8.94
2400	4.44	4.61	5.00	5.30	5.59	5.89	6.18	6.48	6.77	7.06	7.35	7.64	7.92	8.20	8.48	8.75	9.02	9.29
2500	4.61	4.90	5.20	5.51	5.82	6.12	6.43	6.74	7.04	7.34	7.63	7.93	8.22	8.51	8.80	9.08	9.35	9.63
2600	4.50	5.09	5.41	5.72	6.04	6.36	6.68	6.99	7.30	7.61	7.92	8.22	8.52	8.82	9.12	9.35	9.58	9.91
2800	5.15	5.46	5.80	6.14	6.48	6.82	7.15	7.49	7.83	8.15	8.47	8.79	9.11	9.43	9.74	10.03	10.32	10.61
3000	5.50	5.84	6.19	6.55	6.92	7.27	7.63	7.98	8.34	8.68	9.01	9.30	9.58	9.96	10.33	10.61	10.94	11.24
3200	5.86	6.22	6.58	6.97	7.35	7.73	8.09	8.47	8.84	9.19	9.54	9.89	10.24	10.58	10.91	11.22	11.53	11.68
3400	6.20	6.58	6.96	7.27	7.78	8.17	8.56	8.94	9.33	9.70	10.06	10.42	10.78	11.13	11.47	11.79	12.10	12.40
3600	6.55	6.95	7.34	7.78	8.20	8.62	9.00	9.41	9.82	10.19	10.56	10.93	11.30	11.65	12.00	12.32	12.64	12.94
3800	6.96	7.31	7.73	8.17	8.61	9.04	9.45	9.87	10.29	10.67	11.05	11.43	11.80	12.16	12.52	12.84	13.15	13.45
4000	7.23	7.66	8.09	8.57	9.02	9.46	9.88	10.31	10.74	11.13	11.52	11.90	12.28	12.64	13.00	13.32	13.63	13.92
4200	7.58	8.01	8.46	8.94	9.42	9.88	10.30	10.75	11.19	11.58	11.97	12.36	12.74	13.11	13.47	13.78	14.08	14.36
4400	7.92	8.34	8.82	9.33	9.81	10.28	10.71	11.17	11.62	12.02	12.41	12.80	13.18	13.54	13.89	14.19	14.49	14.79
4600	8.25	8.71	9.19	9.70	10.18	10.68	11.12	11.58	12.03	12.43	12.82	13.21	13.59	13.94	14.29	14.57	14.85	15.14
4800	8.56	9.20	9.54	10.06	10.57	11.06	11.50	11.97	12.44	12.83	13.21	13.60	13.98	14.33	14.67	14.94	15.20	15.46
5000	8.90	9.38	9.89	10.42	10.93	11.44	11.88	12.35	12.82	13.21	13.59	13.97	14.35	14.68	15.01	15.26	15.49	15.71
5200	9.21	9.72	10.23	10.77	11.29	11.80	12.24	12.72	13.20	13.57	13.94	14.31	14.68	15.08	15.32	15.54	15.75	15.96
5400	9.53	10.04	10.57	11.12	11.64	12.16	12.60	13.08	13.55	13.91	14.27	14.63	14.99	15.31	15.59	15.80	15.96	16.14
5600	9.83	10.36	10.89	11.45	11.98	12.50	12.94	13.41	13.88	14.27	14.58	14.97	15.27	15.58	15.83	16.00	16.13	16.27
5800	10.15	10.67	11.22	11.78	12.31	12.82	13.26	13.73	14.20	14.59	14.87	15.26	15.52	15.80	16.03	16.16	16.25	16.36
6000	10.45	10.98	11.53	12.09	12.63	13.15	13.57	14.04	14.50	14.88	15.12	15.51	15.74	15.99	16.19	16.28	16.32	16.38

When using this timing belt pulley the operational life will be reduced.

Width correction factor										
Profile and design H										
Belt code	0.50	063	075	100	125	150	175	200	250	300
Belt width [mm]	12.70	15.88	19.05	25.40	31.75	38.10	44.45	50.80	63.50	76.20
Factor	0.42	0.57	0.71	1.00	1.29	1.58	1.84	2.14	2.72	3.36

POWER RATINGS

optibelt ZR PROFILE H

NOMINAL POWER P_N [KW] AT THE BELT WIDTH OF 1" \approx 25,4 MM



Table 32

32 H	33 H	34 H	35 H	36 H	37 H	38 H	39 H	40 H	41 H	42 H	43 H	44 H	45 H	46 H	47 H	48 H	Number of teeth of the small timing belt pulley
129.36	133.40	137.45	141.49	145.53	149.57	153.62	157.66	161.70	165.74	169.79	173.83	177.87	181.91	185.96	190.00	194.04	Pitch diameter [mm]
0.43	0.45	0.46	0.47	0.48	0.50	0.51	0.52	0.53	0.55	0.56	0.57	0.58	0.60	0.61	0.62	0.63	100
0.84	0.87	0.90	0.93	0.95	0.98	1.00	1.03	1.05	1.08	1.11	1.14	1.16	1.19	1.22	1.25	1.27	200
1.27	1.31	1.35	1.39	1.42	1.46	1.50	1.54	1.58	1.62	1.66	1.70	1.74	1.78	1.82	1.86	1.89	300
1.69	1.74	1.79	1.84	1.89	1.95	2.00	2.05	2.10	2.16	2.21	2.26	2.31	2.37	2.42	2.47	2.52	400
2.10	2.17	2.23	2.30	2.36	2.43	2.50	2.57	2.63	2.70	2.76	2.83	2.89	2.96	3.02	3.09	3.15	500
2.52	2.59	2.68	2.76	2.83	2.91	2.99	3.07	3.15	3.23	3.31	3.39	3.46	3.54	3.62	3.70	3.77	600
2.94	3.03	3.12	3.21	3.30	3.39	3.48	3.57	3.66	3.76	3.85	3.94	4.03	4.12	4.21	4.30	4.39	700
3.36	3.47	3.57	3.67	3.77	3.88	3.98	4.08	4.18	4.29	4.39	4.49	4.59	4.69	4.79	4.89	4.99	800
3.77	3.89	4.00	4.12	4.23	4.35	4.46	4.58	4.69	4.81	4.92	5.03	5.14	5.26	5.37	5.48	5.59	900
4.18	4.31	4.44	4.57	4.69	4.82	4.94	5.07	5.19	5.32	5.44	5.57	5.69	5.82	5.94	6.07	6.19	1000
4.59	4.73	4.87	5.01	5.15	5.29	5.42	5.56	5.69	5.83	5.97	6.11	6.24	6.38	6.51	6.64	6.77	1100
4.99	5.14	5.29	5.44	5.59	5.74	5.89	6.04	6.19	6.34	6.48	6.63	6.77	6.92	7.07	7.22	7.36	1200
5.39	5.56	5.72	5.88	6.04	6.20	6.36	6.52	6.68	6.84	6.99	7.15	7.30	7.46	7.61	7.77	7.92	1300
5.80	5.97	6.14	6.31	6.48	6.65	6.82	6.99	7.16	7.33	7.50	7.67	7.83	7.99	8.15	8.31	8.47	1400
6.19	6.38	6.56	6.74	6.92	7.10	7.28	7.46	7.64	7.82	7.99	8.17	8.34	8.51	8.68	8.85	9.02	1500
6.58	6.78	6.97	7.17	7.36	7.55	7.74	7.93	8.11	8.30	8.48	8.66	8.84	9.02	9.20	9.38	9.55	1600
6.97	7.18	7.38	7.58	7.78	7.98	8.18	8.38	8.57	8.76	8.95	9.14	9.33	9.52	9.70	9.89	10.07	1700
7.36	7.57	7.78	7.99	8.20	8.41	8.61	8.82	9.02	9.22	9.42	9.62	9.81	10.01	10.20	10.39	10.58	1800
7.73	7.96	8.18	8.40	8.62	8.84	9.05	9.26	9.47	9.68	9.88	10.08	10.28	10.48	10.67	10.87	11.06	1900
8.11	8.34	8.57	8.80	9.03	9.25	9.47	9.69	9.90	10.11	10.32	10.53	10.74	10.94	11.14	11.34	11.53	2000
8.47	8.71	8.95	9.19	9.42	9.65	9.87	10.10	10.32	10.54	10.75	10.97	11.18	11.39	11.59	11.80	12.00	2100
8.84	9.09	9.33	9.58	9.82	10.05	10.28	10.51	10.74	10.96	11.18	11.40	11.62	11.83	12.03	12.23	12.43	2200
9.20	9.46	9.71	9.96	10.21	10.45	10.68	10.92	11.15	11.37	11.59	11.81	12.03	12.24	12.44	12.65	12.85	2300
9.55	9.81	10.07	10.33	10.58	10.82	11.06	11.30	11.53	11.76	11.98	12.21	12.43	12.64	12.84	13.05	13.25	2400
9.90	10.17	10.43	10.69	10.95	11.20	11.44	11.68	11.92	12.15	12.38	12.61	12.83	13.03	13.23	13.43	13.63	2500
10.24	10.51	10.78	11.05	11.31	11.56	11.80	12.05	12.29	12.52	12.74	12.96	13.18	13.39	13.59	13.79	13.99	2600
10.90	11.18	11.45	11.73	12.00	12.25	12.50	12.75	12.99	13.22	13.44	13.66	13.88	14.07	14.26	14.45	14.64	2800
11.53	11.81	12.09	12.37	12.65	12.90	13.14	13.39	13.63	13.85	14.06	14.28	14.49	14.67	14.85	15.03	15.20	3000
12.14	12.42	12.70	12.98	13.26	13.50	13.74	13.98	14.22	14.42	14.62	14.82	15.02	15.20	15.36	15.53	15.66	3200
12.70	12.98	13.26	13.54	13.82	14.05	14.28	14.51	14.74	14.95	15.14	15.32	15.48	15.62	15.78	15.91	16.01	3400
13.24	13.52	13.79	14.07	14.34	14.56	14.77	14.99	15.20	15.40	15.59	15.77	15.92	16.07	16.21	16.34	16.44	3600
13.74	14.01	14.28	14.55	14.81	15.03	15.22	15.40	15.58	15.72	15.78	15.85	15.90	16.01	16.16	16.23	16.24	3800
14.20	14.49	14.74	14.98	15.22	15.42	15.60	15.76	15.90	15.97	16.03	16.11	16.11	16.20	16.29	16.35	16.35	4000
14.63	14.90	15.15	15.35	15.58	15.85	15.91	16.04	16.13	16.25	16.27	16.29	16.29	16.32	16.38	16.35	16.34	4200
15.01	15.27	15.49	15.67	15.87	16.01	16.13	16.24	16.29	16.33	16.35	16.35	16.36	16.34	16.30	16.25	16.19	4400
15.35	15.58	15.78	15.93	16.10	16.21	16.29	16.35	16.35	16.38	16.38	16.36	16.32	16.28	16.22	16.12	15.90	4600
15.64	15.84	16.01	16.14	16.27	16.33	16.37	16.38	16.33	16.32	16.30	16.27	16.17	16.01	15.81	15.55	15.46	4800
15.88	16.07	16.19	16.29	16.37	16.38	16.38	16.33	16.21	16.15	16.07	15.99	15.89	15.72	15.49	15.23	14.87	5000
16.07	16.23	16.31	16.36	16.40	16.36	16.30	16.19	15.99	15.85	15.70	15.60	15.49	15.28	15.04	14.76		5200
16.21	16.34	16.37	16.37	16.36	16.26	16.13	15.96	15.68	15.52	15.35	15.15	14.96	14.55	14.21			5400
16.30	16.38	16.36	16.32	16.23	16.08	15.88	15.63	15.26	15.07	14.86	14.65						5600
16.33	16.37	16.30	16.19	16.04	15.80	15.53	15.20	14.73	14.30	14.12							5800
16.30	16.29	16.16	15.98	15.76	15.44	15.08	14.67										6000

Rotary frequency of the small timing belt pulley [min⁻¹]

Width correction factor										
Profile and design H										
Belt code	0.50	063	075	100	125	150	175	200	250	300
Belt width [mm]	12.70	15.88	19.05	25.40	31.75	38.10	44.45	50.80	63.50	76.20
Factor	0.42	0.57	0.71	1.00	1.29	1.58	1.84	2.14	2.72	3.36

POWER RATINGS

optibelt **ZR** PROFILE XH

NOMINAL POWER P_N [KW] AT THE BELT WIDTH OF 1" \approx 25,4 MM



Table 33

Number of teeth of the small timing belt pulley	18 XH	19 XH	20 XH	21 XH	22 XH	23 XH	24 XH	25 XH	26 XH	27 XH	28 XH	29 XH	
Pitch diameter [mm]	127.34	134.41	141.49	148.56	155.64	162.71	169.79	176.86	183.94	191.01	198.08	205.16	
Rotary frequency of the small timing belt pulley [min ⁻¹]	100	0.57	0.60	0.63	0.66	0.69	0.73	0.75	0.79	0.83	0.86	0.88	0.91
	200	1.13	1.19	1.25	1.32	1.38	1.45	1.51	1.57	1.63	1.70	1.76	1.82
	300	1.70	1.79	1.88	1.98	2.07	2.17	2.26	2.36	2.45	2.55	2.64	2.73
	400	2.26	2.39	2.51	2.59	2.76	2.89	3.01	3.14	3.26	3.39	3.51	3.63
	500	2.82	2.98	3.13	3.25	3.44	3.59	3.74	3.90	4.06	4.21	4.36	4.52
	600	3.38	3.57	3.74	3.90	4.12	4.30	4.48	4.67	4.85	5.03	5.21	5.39
	700	3.93	4.15	4.36	4.55	4.79	5.00	5.21	5.42	5.62	5.83	6.04	6.25
	800	4.48	4.62	4.97	5.21	5.45	5.69	5.93	6.17	6.41	6.64	6.87	7.10
	900	5.03	5.30	5.57	5.84	6.11	6.37	6.64	6.90	7.15	7.42	7.68	7.93
	1000	5.57	5.87	6.16	6.45	6.75	7.03	7.33	7.62	7.90	8.19	8.47	8.74
	1100	6.11	6.43	6.75	7.07	7.39	7.70	8.02	8.32	8.62	8.93	9.24	9.53
	1200	6.65	6.99	7.33	7.67	8.02	8.35	8.68	9.01	9.33	9.65	9.97	10.32
	1300	7.17	7.54	7.90	8.27	8.63	8.98	9.33	9.68	10.03	10.36	10.68	11.00
	1400	7.68	8.08	8.47	8.84	9.23	9.60	9.97	10.32	10.68	11.03	11.38	11.71
	1500	8.21	8.60	9.01	9.40	9.81	10.19	10.59	10.94	11.32	11.68	12.04	12.37
	1600	8.70	9.12	9.55	9.96	10.38	10.78	11.18	11.54	11.94	12.31	12.67	12.73
	1700	9.18	9.63	10.07	10.49	10.94	11.33	11.76	12.13	12.53	12.90	13.26	13.60
	1800	9.66	10.11	10.58	11.01	11.47	11.88	12.32	12.69	13.10	13.46	13.82	14.16
	1900	10.13	10.60	11.06	11.52	11.99	12.41	12.85	13.36	13.91	14.12	14.35	14.89
	2000	10.57	11.05	11.53	12.00	12.49	12.91	13.35	13.73	14.13	14.47	14.82	15.14
	2100	11.02	11.50	11.99	12.48	12.97	13.40	13.82	14.20	14.59	14.93	15.28	15.57
	2200	11.41	11.92	12.43	12.93	13.43	13.96	14.49	14.76	15.02	15.35	15.67	15.94
	2300	11.87	12.36	12.86	13.38	13.87	14.29	14.70	15.05	15.42	15.71	16.02	16.26
	2400	12.28	12.76	13.26	13.76	14.27	14.68	15.08	15.42	15.77	16.04	16.32	16.53
	2500	12.67	13.15	13.64	14.14	14.66	15.06	15.45	15.76	16.09	16.33	16.58	16.74
	2600	13.05	13.52	14.01	14.51	15.04	15.41	15.77	16.06	16.37	16.57	16.78	16.90
	2800	13.73	14.20	14.66	15.16	15.69	16.02	16.33	16.56	16.78	16.89	17.02	17.03
	3000	14.35	14.77	15.21	15.71	16.22	16.47	16.73	16.87	17.01	17.01	17.02	16.87
3200	14.90	15.28	15.66	16.14	16.63	16.81	16.97	17.01	17.02	16.90	16.76	16.45	
3400	15.36	15.68	15.99	16.45	16.91	16.98	17.04	16.95	16.84	16.54	16.25	15.73	
3600	15.82	16.03	16.23	16.64	17.06	17.01	16.94	16.68	16.43	15.94	15.46	14.72	
3800	16.05	16.19	16.35	16.70	17.06	16.86	16.64	15.96	15.97	15.15	14.34	13.37	
4000	16.26	16.29	16.33	16.62	17.89	16.53	16.15	15.50	14.86	13.91	12.94		
4200	16.35	16.35	16.16	16.37	16.58	16.01	15.45	14.75	13.67	12.60			
4400	16.26	16.22	15.83	15.96	16.08	15.30	14.52	13.24	11.94				

When using this timing belt pulley the operational life will be reduced.

Width correction factor											
Profile and design XH											
Belt code	100	125	150	175	200	250	300	400	500	700	1000
Belt width [mm]	25.40	31.75	38.10	44.45	50.80	63.50	76.20	101.60	127.00	177.80	254.00
Factor	1.00	1.29	1.58	1.84	2.14	2.72	3.36	4.76	6.15	8.89	13.10

POWER RATINGS

optibelt **ZR** PROFILE XH

NOMINAL POWER P_N [KW] AT THE BELT WIDTH OF 1" \approx 25,4 MM



Table 34

30 XH	31 XH	32 XH	33 XH	34 XH	35 XH	36 XH	37 XH	38 XH	39 XH	40 XH	Number of teeth of the small timing belt pulley
212.23	219.31	226.38	233.46	240.53	247.61	254.68	261.75	268.63	275.90	282.98	Pitch diameter [mm]
0.94	0.97	1.00	1.04	1.07	1.10	1.13	1.16	1.19	1.22	1.25	100
1.88	1.95	2.01	2.08	2.14	2.20	2.26	2.33	2.39	2.45	2.51	200
2.82	2.92	3.01	3.11	3.20	3.29	3.38	3.47	3.56	3.65	3.74	300
3.74	3.87	4.00	4.13	4.25	4.37	4.49	4.61	4.73	4.85	4.97	400
4.67	4.84	5.01	5.16	5.30	5.45	5.59	5.74	5.88	6.02	6.16	500
5.57	5.75	5.93	6.11	6.28	6.46	6.63	6.81	6.98	7.16	7.33	600
6.46	6.67	6.87	7.07	7.27	7.47	7.67	7.87	8.07	8.27	8.47	700
7.33	7.56	7.79	8.01	8.23	8.45	8.67	8.89	9.11	9.33	9.55	800
8.18	8.43	8.68	8.92	9.16	9.40	9.63	9.87	10.11	10.35	10.58	900
9.01	9.28	9.55	9.81	10.06	10.31	10.56	10.82	11.07	11.32	11.57	1000
9.81	10.10	10.38	10.65	10.91	11.18	11.44	11.71	11.97	12.23	12.49	1100
10.66	10.92	11.18	11.46	11.73	12.00	12.27	12.54	12.81	13.08	13.35	1200
11.32	11.63	11.94	12.22	12.49	12.77	13.04	13.32	13.59	13.86	14.13	1300
12.04	12.36	12.67	12.94	13.21	13.48	13.75	14.02	14.29	14.56	14.82	1400
12.70	13.03	13.35	13.62	13.88	14.14	14.40	14.67	14.93	15.19	15.45	1500
12.79	13.42	14.04	14.29	14.53	14.77	15.01	15.26	15.50	15.74	15.98	1600
13.94	14.25	14.55	14.79	15.02	15.25	15.48	15.71	15.94	16.17	16.40	1700
14.49	14.79	15.08	15.28	15.48	15.68	15.88	16.08	16.28	16.48	16.67	1800
15.43	15.50	15.56	15.74	15.91	16.08	16.25	16.42	16.59	16.76	16.93	1900
15.45	15.72	15.98	16.12	16.25	16.38	16.51	16.65	16.78	16.91	17.04	2000
15.85	16.09	16.32	16.41	16.53	16.59	16.77	16.88	16.98	17.01	17.02	2100
16.20	16.41	16.61	16.72	16.82	16.84	16.95	17.03	17.01	16.98	16.87	2200
16.49	16.66	16.82	16.88	16.95	16.98	17.02	16.95	16.84	16.74	16.64	2300
16.73	16.85	16.97	17.03	17.04	17.01	16.98	16.83	16.66	16.40	16.15	2400
16.89	16.97	17.04	17.02	16.93	16.87	16.70	16.40	16.22	15.90	15.58	2500
17.01	17.02	17.02	16.95	16.83	16.68	16.55	16.15	15.80	15.31	14.86	2600
17.02	16.88	16.76	16.55	16.25	15.91	15.48	14.97	14.39	13.66	12.94	2800
16.74	16.44	16.15	15.76	15.25	14.69	13.99	13.27				3000
16.15	15.65	15.17	14.56	13.81	12.98						3200
15.23	14.46	13.79	12.94								3400
13.97	13.10										3600
12.41											3800
											4000
											4200
											4400

Width correction factor												
Profile and design XH												
Belt code	100	125	150	175	200	250	300	400	500	700	1000	
Belt width [mm]	25.40	31.75	38.10	44.45	50.80	63.50	76.20	101.60	127.00	177.80	254.00	
Factor	1.00	1.29	1.58	1.84	2.14	2.72	3.36	4.76	6.15	8.89	13.10	

POWER RATINGS

optibelt ZR PROFILE XXH



NOMINAL POWER P_N [KW] AT THE BELT WIDTH OF 1" \approx 25,4 MM

Table 35

Number of teeth of the small timing belt pulley	18 XXH	19 XXH	20 XXH	21 XXH	22 XXH	23 XXH	24 XXH	25 XXH	26 XXH	27 XXH	28 XXH	29 XXH	
Pitch diameter [mm]	181.91	192.02	202.13	212.23	222.34	232.45	242.55	252.66	262.77	272.87	282.98	293.08	
Rotary frequency of the small timing belt pulley [min ⁻¹]	100	0.99	1.05	1.10	1.16	1.22	1.27	1.32	1.38	1.43	1.49	1.54	1.60
	200	1.98	1.09	2.20	2.31	2.42	2.53	2.64	2.75	2.86	2.97	3.08	3.19
	300	2.97	3.14	3.30	3.46	3.62	3.79	3.95	4.11	4.27	4.44	4.60	4.76
	400	3.95	4.17	4.38	4.59	4.80	5.02	5.24	5.46	5.67	5.88	6.09	6.30
	500	4.95	5.21	5.45	5.73	5.98	6.25	6.51	6.77	7.03	7.29	7.55	7.81
	600	5.88	6.20	6.51	6.83	7.14	7.45	7.76	8.07	8.37	8.67	8.97	9.27
	700	6.83	7.19	7.56	7.92	8.27	8.62	8.97	9.32	9.67	10.01	10.35	10.69
	800	7.76	8.18	8.57	8.98	9.37	9.77	10.16	10.54	10.92	11.29	11.66	12.03
	900	8.72	9.18	9.57	10.01	10.44	10.88	11.30	11.71	12.11	12.51	12.91	13.31
	1000	9.57	10.02	10.55	11.02	11.49	11.95	12.13	12.71	13.28	13.70	14.11	14.52
	1100	10.44	10.97	11.49	12.05	12.64	13.04	13.43	13.90	14.37	14.79	15.21	15.63
	1200	11.40	11.85	12.40	12.92	13.45	13.95	14.45	14.91	15.38	15.80	16.22	16.64
	1300	12.12	12.70	13.28	13.81	14.37	14.60	14.83	15.57	16.32	16.73	17.14	17.55
	1400	12.90	13.51	14.12	14.66	15.23	15.73	16.26	16.70	17.18	17.57	17.95	18.34
	1500	13.66	14.28	14.91	15.46	16.04	16.54	17.05	17.71	17.96	18.31	18.66	19.01
	1600	14.39	15.03	15.68	16.23	17.04	17.28	17.78	18.38	18.64	18.95	19.25	19.56
	1700	15.07	15.73	16.40	16.93	17.49	17.95	18.43	18.81	19.21	19.46	19.70	19.95
	1800	15.71	16.37	17.06	17.58	18.12	18.55	19.00	19.33	19.68	19.93	20.12	20.24
	1900	16.31	16.98	17.67	18.16	18.68	19.07	19.48	19.74	20.04	20.13	20.25	20.30
	2000	16.88	17.54	18.23	18.69	19.17	19.51	19.86	20.05	20.28	20.35	20.38	20.28
	2100	17.39	18.05	18.73	19.14	19.58	19.84	20.14	20.25	20.39	20.29	20.18	20.00
	2200	17.84	18.50	19.17	19.54	19.91	20.11	20.32	20.33	20.37	20.22	19.98	19.60
	2300	18.25	18.90	19.55	19.84	20.16	20.28	20.39	20.30	20.21	19.76	19.45	18.94
	2400	18.60	19.22	19.86	20.09	20.32	20.30	20.35	20.12	19.91	19.47	18.91	18.19
	2500	18.90	19.50	22.34	21.37	20.39	20.28	20.19	19.80	19.45	18.75	18.00	17.11
	2600	19.15	19.72	20.28	20.32	20.37	20.12	19.91	19.36	18.84	18.04	17.10	
	2800	19.44	19.92	20.40	20.21	20.02	19.46	18.96	18.04	17.12	15.89		
	3000	19.49	19.85	20.19	19.74	19.24	18.32	17.43	16.06	14.66			

When using this timing belt pulley the operational life will be reduced.

Width correction factor											
Profile and design XXH											
Belt code	100	125	150	175	200	250	300	400	500	700	1000
Belt width [mm]	25.40	31.75	38.10	44.45	50.80	63.50	76.20	101.60	127.00	177.80	254.00
Factor	1.00	1.29	1.58	1.84	2.14	2.72	3.36	4.76	6.15	8.89	13.10

POWER RATINGS

optibelt ZR PROFILE XXH



NOMINAL POWER P_N [KW] AT THE BELT WIDTH OF 1" \approx 25,4 MM

Table 36

30 XXH	31 XXH	32 XXH	33 XXH	34 XXH	35 XXH	36 XXH	37 XXH	38 XXH	39 XXH	40 XXH	Number of teeth of the small timing belt pulley
303.19	313.30	323.40	333.51	343.62	353.72	363.83	373.94	384.04	394.15	404.25	Pitch diameter [mm]
1.65	1.70	1.76	1.81	1.87	1.92	1.98	2.05	2.14	2.20	2.20	100
3.30	3.39	3.50	3.61	3.73	3.82	3.93	4.07	4.20	4.41	4.38	200
4.92	5.08	5.32	5.40	5.56	5.71	5.87	6.05	6.22	6.38	6.51	300
6.51	6.73	6.93	7.14	7.35	7.54	7.75	7.97	8.19	8.39	8.57	400
8.06	8.32	8.57	8.82	9.08	9.31	9.55	9.82	10.08	10.31	10.54	500
9.57	9.86	10.15	10.43	10.73	11.00	11.28	11.56	11.86	12.14	12.40	600
11.02	11.34	11.67	11.98	12.32	12.60	12.91	13.22	13.53	13.83	14.12	700
12.40	12.75	13.10	13.34	13.79	14.12	14.39	14.75	15.06	15.39	15.68	800
13.70	14.08	14.44	14.59	15.15	15.49	15.82	16.12	16.55	16.76	17.05	900
14.93	15.30	15.67	16.02	16.40	16.72	16.98	17.24	17.65	17.94	18.23	1000
16.04	16.42	16.71	17.05	17.49	17.71	18.00	18.29	18.55	18.86	19.17	1100
17.05	17.41	17.76	18.08	18.43	18.71	18.97	19.23	19.45	19.65	19.86	1200
17.96	18.21	18.53	18.81	19.21	19.39	19.55	19.74	19.89	20.08	20.28	1300
18.72	19.01	19.29	19.34	19.80	19.97	20.08	20.20	20.32	20.36	20.39	1400
19.36	19.52	19.74	19.92	20.19	20.20	20.21	20.23	20.21	20.19	20.18	1500
19.86	20.03	20.19	20.29	20.38	20.33	20.28	20.23	20.05	19.86	19.64	1600
20.19	20.21	20.26	20.30	20.34	20.01	19.78	19.66	19.34	19.04	18.73	1700
20.37	20.38	20.33	20.28	20.06	19.73	19.40	19.07	18.59	18.02	17.43	1800
20.37	20.27	19.98	19.74	19.53	18.97	18.41	17.84	17.15	16.33	15.50	1900
20.19	19.95	19.63	19.16	18.73	18.03	17.33	16.62	15.70	14.65	13.58	2000
19.81	19.31	18.80	18.20	17.65	16.66	15.67	14.67				2100
19.24	18.66	17.98	17.17	16.23	15.22						2200
18.46	17.59	16.65									2300
17.43	16.44										2400
											2500
											2600
											2800
											3000

Rotary frequency of the small timing belt pulley [min⁻¹]

When using this timing belt pulley the operational life will be reduced.

Width correction factor											
Profile and design XXH											
Belt code	100	125	150	175	200	250	300	400	500	700	1000
Belt width [mm]	25.40	31.75	38.10	44.45	50.80	63.50	76.20	101.60	127.00	177.80	254.00
Factor	1.00	1.29	1.58	1.84	2.14	2.72	3.36	4.76	6.15	8.89	13.10

DIMENSIONS AND TOLERANCES

TIMING BELTS IN optibelt OMEGA PROFILE



Timing belts with optibelt OMEGA profiles are produced in a wide range of lengths and widths. Many special lengths, widths and designs are available. Please contact our Application Engineering Department for further details. Timing belts with optibelt OMEGA profiles are produced to ground category G2 with a thickness tolerance of ± 0.25 mm as standard. If required, the belts can be ground to category G1 with a thickness tolerance of ± 0.13 mm.

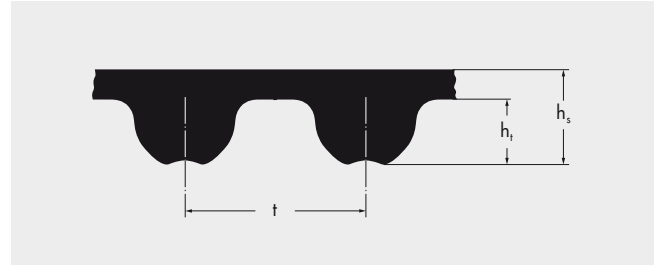

Table 37
Nominal dimensions and weights

Profile	2M	3M	5M	8M	D8M	14M
Tooth height h_t [mm]	0.70	1.10	1.90	3.20	3.20	5.60
Total belt thickness h_s [mm]	1.30	2.30	3.40	5.40	7.73	9.50
Tooth pitch t [mm]	2.00	3.00	5.00	8.00	8.00	14.00
Weight [kg/m] for 10 mm belt width	0.013	0.024	0.035	0.058	0.067	0.100

Length tolerances

Pitch length [mm]	≤ 250	> 250 ≤ 500	> 500 ≤ 750	> 750 ≤ 1000	> 1000 ≤ 1250	> 1250 ≤ 1500	> 1500 ≤ 1750	> 1750 ≤ 2000	> 2000 ≤ 2250	> 2250 ≤ 2500	> 2500 ≤ 2750	> 2750 ≤ 3000	> 3000
Length tolerances given as centre distance deviation	± 0.20	± 0.23	± 0.27	± 0.30	± 0.33	± 0.36	± 0.39	± 0.42	± 0.46	± 0.49	± 0.52	± 0.55	± 0.55 $\pm 0.03^*$

Width tolerance

Standard belt width	Allowed tolerance [mm] of the timing belt			
	Nominal width [mm]	Pitch length up to 838.2 mm	Pitch length 838.3 up to 1676.4 mm	Pitch length over 1676.4 mm
3.0 to 11.0		+ 0.4 - 0.8	+ 0.4 - 0.8	—
11.1 to 38.1		+ 0.8 - 0.8	+ 0.8 - 0.8	+ 0.8 - 1.2
38.2 to 50.8		+ 0.8 - 1.2	+ 1.2 - 1.2	+ 1.2 - 1.6
50.9 to 63.5		+ 1.2 - 1.2	+ 1.2 - 1.6	+ 1.6 - 1.6
63.6 to 76.2		+ 1.2 - 1.6	+ 1.6 - 1.6	+ 1.6 - 2.0
76.3 to 101.6		+ 1.6 - 1.6	+ 1.6 - 2.0	+ 2.0 - 2.0
101.7 to 177.8		+ 2.4 - 2.4	+ 1.6 - 2.0	+ 2.0 - 2.0
177.9 to max.		—	—	+ 4.8 - 6.4

* For greater lengths additional 0.03 mm should be added in length steps of 250 mm.

TIMING BELT PULLEYS

FOR TIMING BELTS IN optibelt OMEGA PROFILE

PROFILE 3M



Number of teeth	Pitch diameter [mm]	Outside diameter [mm]	Number of teeth	Pitch diameter [mm]	Outside diameter [mm]	Number of teeth	Pitch diameter [mm]	Outside diameter [mm]	Number of teeth	Pitch diameter [mm]	Outside diameter [mm]
10	9.55	8.79	50	47.75	46.99	90	85.94	85.18	130	124.14	123.38
11	10.50	9.74	51	48.70	47.94	91	86.90	86.14	131	125.10	124.33
12	11.46	10.70	52	49.66	48.90	92	87.85	87.09	132	126.05	125.29
13	12.41	11.65	53	50.61	49.85	93	88.81	88.05	133	127.01	126.24
14	13.37	12.61	54	51.57	50.81	94	89.76	89.00	134	127.96	127.20
15	14.32	13.56	55	52.52	51.76	95	90.72	89.96	135	128.92	128.15
16	15.28	14.52	56	53.48	52.72	96	91.67	90.91	136	129.87	129.11
17	16.23	15.47	57	54.43	53.67	97	92.63	91.87	137	130.83	130.06
18	17.19	16.43	58	55.39	54.63	98	93.58	92.82	138	131.78	131.02
19	18.14	17.38	59	56.34	55.58	99	94.54	93.78	139	132.74	131.97
20	19.10	18.34	60	57.30	56.54	100	95.49	94.73	140	133.69	132.93
21	20.05	19.29	61	58.25	57.49	101	96.45	95.69	141	134.65	133.88
22	21.01	20.25	62	59.21	58.45	102	97.40	96.64	142	135.60	134.84
23	21.96	21.20	63	60.16	59.40	103	98.36	97.60	143	136.55	135.79
24	22.92	22.16	64	61.12	60.36	104	99.31	98.55	144	137.51	136.75
25	23.87	23.11	65	62.07	61.31	105	100.27	99.51	145	138.46	137.70
26	24.83	24.07	66	63.03	62.27	106	101.22	100.46	146	139.42	138.66
27	25.78	25.02	67	63.98	63.22	107	102.18	101.42	147	140.37	139.61
28	26.74	25.98	68	64.94	64.18	108	103.13	102.37	148	141.33	140.57
29	27.69	26.93	69	65.89	65.13	109	104.09	103.33	149	142.28	141.52
30	28.65	27.89	70	66.85	66.09	110	105.04	104.28	150	143.24	142.48
31	29.60	28.84	71	67.80	67.04	111	106.00	105.24			
32	30.56	29.80	72	68.75	67.99	112	106.95	106.19			
33	31.51	30.75	73	69.71	68.95	113	107.91	107.15			
34	32.47	31.71	74	70.66	69.90	114	108.86	108.10			
35	33.42	32.66	75	71.62	70.86	115	109.82	109.06			
36	34.38	33.62	76	72.57	71.81	116	110.77	110.01			
37	35.33	34.57	77	73.53	72.77	117	111.73	110.97			
38	36.29	35.53	78	74.48	73.72	118	112.68	111.92			
39	37.24	36.48	79	75.44	74.68	119	113.64	112.88			
40	38.20	37.44	80	76.39	75.63	120	114.59	113.83			
41	39.15	38.39	81	77.35	76.59	121	115.55	114.79			
42	40.11	39.35	82	78.30	77.54	122	116.50	115.74			
43	41.06	40.30	83	79.26	78.50	123	117.46	116.70			
44	42.02	41.26	84	80.21	79.45	124	118.41	117.65			
45	42.97	42.21	85	81.17	80.41	125	119.37	118.61			
46	43.93	43.17	86	82.12	81.36	126	120.32	119.56			
47	44.88	44.12	87	83.08	82.32	127	121.28	120.52			
48	45.84	45.08	88	84.03	83.27	128	122.23	121.47			
49	46.79	46.03	89	84.99	84.23	129	123.19	122.43			

TIMING BELT PULLEYS

FOR TIMING BELTS IN **optibelt OMEGA PROFILE**

PROFILE 5M



Number of teeth	Pitch diameter [mm]	Outside diameter [mm]	Number of teeth	Pitch diameter [mm]	Outside diameter [mm]	Number of teeth	Pitch diameter [mm]	Outside diameter [mm]	Number of teeth	Pitch diameter [mm]	Outside diameter [mm]
12	19.10	17.96	52	82.76	81.62	92	146.42	145.28	132	210.08	208.94
13	20.69	19.55	53	84.35	83.21	93	148.01	146.87	133	211.68	210.54
14	22.28	21.14	54	85.94	84.80	94	149.61	148.47	134	213.27	212.13
15	23.87	22.73	55	87.54	86.40	95	151.20	150.06	135	214.86	213.72
16	25.46	24.32	56	89.13	87.98	96	152.79	151.65	136	216.45	215.31
17	27.06	25.92	57	90.72	89.58	97	154.38	153.24	137	218.04	216.90
18	28.65	27.51	58	92.31	91.17	98	155.97	154.83	138	219.63	218.49
19	30.24	29.10	59	93.90	92.76	99	157.56	156.42	139	221.23	220.09
20	31.83	30.69	60	95.49	94.35	100	159.15	158.01	140	222.82	221.68
21	33.42	32.28	61	97.08	95.94	101	160.75	159.61	141	224.41	223.27
22	35.01	33.87	62	98.68	97.54	102	162.34	161.20	142	226.00	224.86
23	36.61	35.47	63	100.27	99.13	103	163.93	162.79	143	227.59	226.45
24	38.20	37.05	64	101.86	100.72	104	165.52	164.38	144	229.18	228.04
25	39.79	38.65	65	103.45	102.31	105	167.11	165.97	145	230.77	229.63
26	41.38	40.24	66	105.04	103.90	106	168.70	167.56	146	232.37	231.23
27	42.97	41.83	67	106.63	105.49	107	170.30	169.16	147	233.96	232.82
28	44.56	43.42	68	108.23	107.09	108	171.89	170.75	148	235.55	234.41
29	46.15	45.01	69	109.82	108.68	109	173.48	172.34	149	237.14	236.00
30	47.75	46.60	70	111.41	110.27	110	175.07	173.93	150	238.73	237.59
31	49.34	48.20	71	113.00	111.86	111	176.66	175.52			
32	50.93	49.79	72	114.59	113.45	112	178.25	177.11			
33	52.52	51.38	73	116.18	115.04	113	179.85	178.71			
34	54.11	52.97	74	117.77	116.63	114	181.44	180.30			
35	55.70	54.56	75	119.37	118.23	115	183.03	181.89			
36	57.30	56.16	76	120.96	119.82	116	184.62	183.48			
37	58.89	57.75	77	122.55	121.41	117	186.21	185.07			
38	60.48	59.34	78	124.14	123.00	118	187.80	186.66			
39	62.07	60.93	79	125.73	124.59	119	189.39	188.25			
40	63.66	62.52	80	127.32	126.18	120	190.99	189.85			
41	65.25	64.11	81	128.92	127.78	121	192.58	191.44			
42	66.85	65.71	82	130.51	129.37	122	194.17	193.03			
43	68.44	67.30	83	132.10	130.96	123	195.76	194.62			
44	70.03	68.89	84	133.69	132.55	124	197.35	196.21			
45	71.62	70.48	85	135.28	134.14	125	198.94	197.80			
46	73.21	72.07	86	136.87	135.73	126	200.54	199.40			
47	74.80	73.66	87	138.46	137.32	127	202.13	200.99			
48	76.39	75.25	88	140.06	138.92	128	203.72	202.58			
49	77.99	76.85	89	141.65	140.51	129	205.31	204.17			
50	79.58	78.43	90	143.24	142.10	130	206.90	205.76			
51	81.17	80.03	91	144.83	143.69	131	208.49	207.35			

TIMING BELT PULLEYS

FOR TIMING BELTS IN **optibelt OMEGA PROFILE**

PROFILE 8M



Number of teeth	Pitch diameter [mm]	Outside diameter [mm]	Number of teeth	Pitch diameter [mm]	Outside diameter [mm]	Number of teeth	Pitch diameter [mm]	Outside diameter [mm]	Number of teeth	Pitch diameter [mm]	Outside diameter [mm]
22	56.02	54.65	67	170.61	169.24	112	285.21	283.83	157	399.80	398.43
23	58.57	57.20	68	173.16	171.79	113	287.75	286.38	158	402.34	400.97
24	61.12	59.75	69	175.71	174.34	114	290.30	288.93	159	404.89	403.52
25	63.66	62.29	70	178.25	176.88	115	292.85	291.47	160	407.44	406.07
26	66.21	64.84	71	180.80	179.43	116	295.39	294.02	161	409.98	408.61
27	68.75	67.38	72	183.35	181.97	117	297.94	296.57	162	412.53	411.16
28	71.30	69.93	73	185.89	184.52	118	300.48	299.11	163	415.08	413.70
29	73.85	72.48	74	188.44	187.07	119	303.03	301.66	164	417.62	416.25
30	76.39	75.13	75	190.99	189.61	120	305.58	304.21	165	420.17	418.80
31	78.94	77.65	76	193.53	192.16	121	308.12	306.75	166	422.72	421.34
32	81.49	80.16	77	196.08	194.71	122	310.67	309.30	167	425.26	423.89
33	84.03	82.68	78	198.62	197.25	123	313.22	311.85	168	427.81	426.44
34	86.58	85.22	79	201.17	199.81	124	315.76	314.39	169	430.35	428.98
35	89.13	87.76	80	203.72	202.35	125	318.31	316.94	170	432.90	431.53
36	91.67	90.30	81	206.26	204.89	126	320.86	319.48	171	435.45	434.08
37	94.22	92.85	82	208.81	207.44	127	323.41	322.03	172	437.99	436.62
38	96.77	95.39	83	211.36	209.99	128	325.95	324.58	173	440.54	439.17
39	99.31	97.94	84	213.90	212.53	129	328.50	327.12	174	443.09	441.72
40	101.86	100.49	85	216.45	215.08	130	331.04	329.67	175	445.63	444.26
41	104.41	103.03	86	219.00	217.63	131	333.59	332.22	176	448.18	446.81
42	106.95	105.58	87	221.54	220.17	132	336.14	334.76	177	450.73	449.36
43	109.50	108.13	88	224.09	222.72	133	338.68	337.31	178	453.27	451.90
44	112.05	110.67	89	226.54	225.27	134	341.23	339.86	179	455.82	454.45
45	114.59	113.22	90	229.18	227.81	135	343.77	342.40	180	458.37	456.99
46	117.14	115.77	91	231.73	230.36	136	346.32	344.95	181	460.91	459.54
47	119.68	118.31	92	234.28	232.90	137	348.87	347.50	182	463.46	462.09
48	122.23	120.86	93	236.82	235.45	138	351.41	350.04	183	466.01	464.63
49	124.78	123.41	94	239.37	238.00	139	353.96	352.59	184	468.55	467.18
50	127.32	125.95	95	241.92	240.54	140	356.51	355.14	185	471.10	469.73
51	129.87	128.50	96	244.46	243.09	141	359.05	357.68	186	473.65	472.27
52	132.42	131.05	97	247.01	245.64	142	361.60	360.23	187	476.19	474.82
53	134.96	133.59	98	249.55	248.18	143	364.15	362.77	188	478.74	477.37
54	137.51	136.14	99	252.10	250.73	144	366.69	365.32	189	481.28	479.91
55	140.06	138.68	100	254.65	253.28	145	369.24	367.87	190	483.83	482.46
56	142.60	141.23	101	257.19	255.82	146	371.79	370.41	191	486.38	485.01
57	145.15	143.78	102	259.74	258.37	147	374.33	372.96	192	488.92	487.55
58	147.70	146.32	103	262.29	260.92	148	376.88	375.51			
59	150.24	148.87	104	264.83	263.46	149	379.43	378.05			
60	152.79	151.42	105	267.38	266.01	150	381.97	380.60			
61	155.34	153.96	106	269.93	268.56	151	384.52	383.15			
62	157.88	156.51	107	272.47	271.10	152	387.06	385.70			
63	160.43	159.06	108	275.02	273.65	153	389.61	388.24			
64	162.97	161.60	109	277.57	276.19	154	392.16	390.79			
65	165.52	164.15	110	280.11	278.74	155	394.70	393.33			
66	168.07	166.70	111	282.66	281.29	156	397.25	395.88			

TIMING BELT PULLEYS

FOR TIMING BELTS IN optibelt OMEGA PROFILE

PROFILE 14M



Number of teeth	Pitch diameter [mm]	Outside diameter [mm]	Number of teeth	Pitch diameter [mm]	Outside diameter [mm]	Number of teeth	Pitch diameter [mm]	Outside diameter [mm]	Number of teeth	Pitch diameter [mm]	Outside diameter [mm]
28	124.78	122.12	73	325.31	322.52	118	525.85	523.05	163	726.38	723.59
29	129.23	126.57	74	329.77	326.97	119	530.30	527.51	164	730.84	728.05
30	133.69	130.99	75	334.22	331.43	120	534.76	531.97	165	735.30	732.50
31	138.15	135.46	76	338.68	335.89	121	539.22	536.42	166	739.75	736.96
32	142.60	139.88	77	343.14	340.34	122	543.67	540.88	167	744.21	741.41
33	147.06	144.35	78	347.59	344.80	123	548.13	545.34	168	748.66	745.87
34	151.51	148.79	79	352.05	349.26	124	552.59	549.79	169	753.12	750.33
35	155.97	153.24	80	356.51	353.71	125	557.04	554.25	170	757.58	754.78
36	160.43	157.68	81	360.96	358.17	126	561.50	558.70	171	762.03	759.24
37	164.88	162.13	82	365.42	362.63	127	565.95	563.16	172	766.49	763.70
38	169.34	166.60	83	369.88	367.08	128	570.41	567.62	173	770.95	768.15
39	173.80	171.02	84	374.33	371.54	129	574.87	572.07	174	775.40	772.61
40	178.25	175.49	85	378.79	375.99	130	579.32	576.53	175	779.86	777.06
41	182.71	179.92	86	383.24	380.45	131	583.78	580.99	176	784.32	781.52
42	187.17	184.37	87	387.70	384.91	132	588.24	585.44	177	788.77	785.98
43	191.62	188.83	88	392.16	389.36	133	592.69	589.90	178	793.23	790.43
44	196.08	193.28	89	396.61	393.82	134	597.15	594.35	179	797.68	794.89
45	200.53	197.74	90	401.07	398.28	135	601.61	598.81	180	802.14	799.35
46	204.99	202.30	91	405.53	402.73	136	606.06	603.27	181	806.60	803.80
47	209.45	206.65	92	409.98	407.19	137	610.52	607.72	182	811.05	808.26
48	213.90	211.11	93	414.44	411.64	138	614.97	612.18	183	815.51	812.72
49	218.36	215.57	94	418.90	416.10	139	619.43	616.64	184	819.97	817.17
50	222.82	220.02	95	423.35	420.56	140	623.89	621.09	185	824.42	821.63
51	227.27	224.48	96	427.81	425.01	141	628.34	625.55	186	828.88	826.08
52	231.73	228.94	97	432.26	429.47	142	632.80	630.01	187	833.33	830.54
53	236.19	233.39	98	436.72	433.93	143	637.26	634.46	188	837.79	835.00
54	240.64	237.85	99	441.18	438.38	144	641.71	638.92	189	842.25	839.45
55	245.10	242.30	100	445.63	442.84	145	646.17	643.37	190	846.70	843.91
56	249.55	246.76	101	450.09	447.30	146	650.63	647.83	191	851.16	848.37
57	254.01	251.22	102	454.55	451.75	147	655.08	652.29	192	855.62	852.82
58	258.47	255.67	103	459.00	456.21	148	659.54	656.74	216	962.57	959.77
59	262.92	260.13	104	463.46	460.66	149	663.99	661.20			
60	267.38	264.59	105	467.92	465.12	150	668.45	665.66			
61	271.84	269.04	106	472.37	469.58	151	672.91	670.11			
62	276.29	273.50	107	476.83	474.03	152	677.36	674.57			
63	280.75	277.95	108	481.28	478.49	153	681.82	679.03			
64	285.21	282.41	109	485.74	482.95	154	686.28	683.48			
65	289.66	286.87	110	490.20	487.40	155	690.73	687.94			
66	294.12	291.32	111	494.65	491.86	156	695.19	692.39			
67	298.57	295.78	112	499.11	496.32	157	699.64	696.85			
68	303.03	300.24	113	503.57	500.77	158	704.10	701.31			
69	307.49	304.69	114	508.02	505.23	159	708.56	705.76			
70	311.94	309.15	115	512.48	509.68	160	713.01	710.22			
71	316.40	313.61	116	516.93	514.14	161	717.47	714.68			
72	320.86	318.06	117	521.39	518.60	162	721.93	719.13			

TIMING BELT PULLEYS

optibelt ZRS HTD® TIMING BELT PULLEYS FOR CYLINDRICAL BORES PROFILE 3M

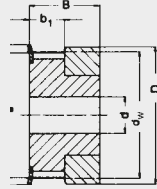

Design 1F

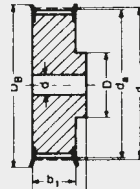

Design 6F

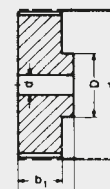

Design 6

Profile 3M – Tooth pitch 3 mm for belt width 6 mm (Not available ex stock)

Designation	Number of teeth	Design	Material	d _w [mm]	d _a [mm]	D _B [mm]	b ₁ [mm]	B [mm]	D [mm]	Pilot bore d [mm]	Finished bore d _{max} [mm]	Weight ≈ [kg]
10-3M-6	10	1F	Al	9.55	8.79	13.0	7.2	14.5	13.0	—	3	
12-3M-6	12	1F	Al	11.46	10.70	15.0	7.2	14.5	15.0	—	5	
14-3M-6	14	1F	Al	13.37	12.61	16.0	7.2	14.5	16.0	—	6	
15-3M-6	15	1F	Al	14.32	13.56	17.5	7.2	14.5	17.5	—	6	
16-3M-6	16	6F	Al	15.28	14.52	18.0	9.8	17.5	10.0	4	7	
18-3M-6	18	6F	Al	17.19	16.43	19.5	9.8	17.5	11.0	6	8	
20-3M-6	20	6F	Al	19.10	18.34	23.0	9.8	17.5	13.0	6	9	
21-3M-6	21	6F	Al	20.05	19.29	25.0	9.8	17.5	14.0	6	9	
22-3M-6	22	6F	Al	21.01	20.25	25.0	9.8	17.5	14.0	6	9	
24-3M-6	24	6F	Al	22.92	22.16	25.0	9.8	17.5	14.0	6	9	
26-3M-6	26	6F	Al	24.83	24.07	28.0	9.8	17.5	16.0	6	11	
28-3M-6	28	6F	Al	26.74	25.98	32.0	9.8	17.5	18.0	6	12	
30-3M-6	30	6F	Al	28.65	27.89	32.0	9.8	17.5	20.0	6	14	
32-3M-6	32	6F	Al	30.56	29.80	36.0	9.8	17.5	22.0	6	15	
36-3M-6	36	6F	Al	34.38	33.62	38.0	10.3	18.0	26.0	6	16	
40-3M-6	40	6F	Al	38.20	37.44	42.0	10.3	18.0	28.0	6	18	
44-3M-6	44	6F	Al	42.02	41.26	48.0	10.3	18.0	33.0	6	20	
48-3M-6	48	6	Al	45.84	45.08	—	10.3	18.6	33.0	8	20	
60-3M-6	60	6	Al	57.30	56.54	—	10.3	18.6	33.0	8	20	
72-3M-6	72	6	Al	68.75	67.99	—	10.3	18.6	33.0	8	20	

Profile 3M – Tooth pitch 3 mm for belt width 9 mm

10-3M-9	10	1F	Al	9.55	8.79	13.0	10.2	17.5	13.0	—	3	0.004
12-3M-9	12	1F	Al	11.46	10.70	15.0	10.2	17.5	15.0	—	5	0.006
14-3M-9	14	1F	Al	13.37	12.61	16.0	10.2	17.5	16.0	—	6	0.007
15-3M-9	15	1F	Al	14.32	13.56	17.5	10.2	17.5	17.5	—	6	0.008
16-3M-9	16	6F	Al	15.28	14.52	18.0	12.8	20.6	10.0	4	7	0.007
18-3M-9	18	6F	Al	17.19	16.43	19.5	12.8	20.6	11.0	6	8	0.008
20-3M-9	20	6F	Al	19.10	18.34	23.0	12.8	20.6	13.0	6	9	0.010
21-3M-9	21	6F	Al	20.05	19.29	25.0	12.8	20.6	14.0	6	9	0.013
22-3M-9	22	6F	Al	21.01	20.25	25.0	12.8	20.6	14.0	6	9	0.014
24-3M-9	24	6F	Al	22.92	22.16	25.0	12.8	20.6	14.0	6	9	0.016
26-3M-9	26	6F	Al	24.83	24.07	28.0	12.8	20.6	16.0	6	11	0.018
28-3M-9	28	6F	Al	26.74	25.98	32.0	12.8	20.6	18.0	6	12	0.024
30-3M-9	30	6F	Al	28.65	27.89	32.0	12.8	20.6	20.0	6	14	0.028
32-3M-9	32	6F	Al	30.56	29.80	36.0	12.8	20.6	22.0	6	15	0.032
36-3M-9	36	6F	Al	34.38	33.62	38.0	13.4	22.2	26.0	6	16	0.045
40-3M-9	40	6F	Al	38.20	37.44	42.0	13.4	22.2	28.0	6	18	0.055
44-3M-9	44	6F	Al	42.02	41.26	48.0	13.4	22.2	33.0	6	20	0.074
48-3M-9	48	6	Al	45.84	45.08	—	13.4	22.2	33.0	8	20	0.074
60-3M-9	60	6	Al	57.30	56.54	—	13.4	22.2	33.0	8	20	0.106
72-3M-9	72	6	Al	68.75	67.99	—	13.4	22.2	33.0	8	20	0.145

Al = Aluminium Subject to changes due to production.

TIMING BELT PULLEYS

optibelt ZRS HTD® TIMING BELT PULLEYS FOR CYLINDRICAL BORES PROFILES 3M AND 5M

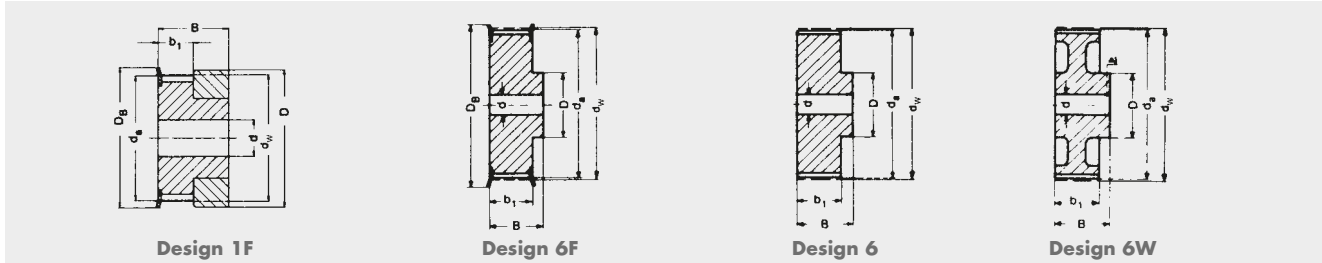

Profile 3M – Tooth pitch 3 mm for belt width 15 mm

Designation	Number of teeth	Design	Material	d _w [mm]	d _o [mm]	D _B [mm]	b ₁ [mm]	B [mm]	D [mm]	Pilot bore d [mm]	Finished bore d _{max} [mm]	Weight ≈ [kg]
10-3M-15	10	1F	Al	9.55	8.79	13.0	17.0	26	13.0	—	3	0.006
12-3M-15	12	1F	Al	11.46	10.70	15.0	17.0	26	15.0	—	5	0.008
14-3M-15	14	1F	Al	13.37	12.61	16.0	17.0	26	16.0	—	6	0.010
15-3M-15	15	1F	Al	14.32	13.56	17.5	17.0	26	17.5	—	6	0.012
16-3M-15	16	6F	Al	15.28	14.52	18.0	19.5	26	10.0	4	7	0.010
18-3M-15	18	6F	Al	17.19	16.43	19.5	19.5	26	11.0	6	8	0.012
20-3M-15	20	6F	Al	19.10	18.34	23.0	19.5	26	13.0	6	9	0.014
21-3M-15	21	6F	Al	20.05	19.29	25.0	19.5	26	14.0	6	9	0.016
22-3M-15	22	6F	Al	21.01	20.25	25.0	19.5	26	14.0	6	9	0.018
24-3M-15	24	6F	Al	22.92	22.16	25.0	19.5	26	14.0	6	9	0.020
26-3M-15	26	6F	Al	24.83	24.07	28.0	19.5	26	16.0	6	11	0.027
28-3M-15	28	6F	Al	26.74	25.98	32.0	19.5	26	18.0	6	12	0.030
30-3M-15	30	6F	Al	28.65	27.89	32.0	19.5	26	20.0	6	14	0.035
32-3M-15	32	6F	Al	30.56	29.80	36.0	19.5	26	22.0	6	15	0.042
36-3M-15	36	6F	Al	34.38	33.62	38.0	20.0	30	26.0	6	16	0.060
40-3M-15	40	6F	Al	38.20	37.44	42.0	20.0	30	28.0	6	18	0.075
44-3M-15	44	6F	Al	42.02	41.26	48.0	20.0	30	33.0	6	20	0.100
48-3M-15	48	6	Al	45.84	45.08	—	20.0	30	33.0	8	20	0.103
60-3M-15	60	6	Al	57.30	56.54	—	20.0	30	33.0	8	20	0.150
72-3M-15	72	6	Al	68.75	67.99	—	20.0	30	33.0	8	20	0.212

Profile 5M – Tooth pitch 5 mm for belt width 9 mm

12-5M-9	12	6F	St	19.10	17.96	23	14.5	20.0	13.0	4	7	0.028
14-5M-9	14	6F	St	22.28	21.14	25	14.5	20.0	14.0	6	8	0.034
15-5M-9	15	6F	St	23.87	22.73	28	14.5	20.0	16.0	6	10	0.042
16-5M-9	16	6F	St	25.46	24.32	28	14.5	20.0	16.5	6	10	0.050
18-5M-9	18	6F	St	28.65	27.51	32	14.5	20.0	20.0	6	12	0.070
20-5M-9	20	6F	St	31.83	30.69	36	14.5	22.5	23.0	6	14	0.094
21-5M-9	21	6F	St	33.42	32.28	38	14.5	22.5	24.0	6	14	0.110
22-5M-9	22	6F	St	35.01	33.87	38	14.5	22.5	25.5	6	14	0.118
24-5M-9	24	6F	St	38.20	37.06	42	14.5	22.5	27.0	6	16	0.145
26-5M-9	26	6F	St	41.38	40.24	44	14.5	22.5	30.0	6	18	0.170
28-5M-9	28	6F	St	44.56	43.42	48	14.5	22.5	30.5	6	18	0.200
30-5M-9	30	6F	St	47.75	46.61	51	14.5	22.5	35.0	6	20	0.236
32-5M-9	32	6F	St	50.93	49.79	54	14.5	22.5	38.0	8	22	0.270
36-5M-9	36	6F	St	57.30	56.16	60	14.5	22.5	38.0	8	22	0.324
40-5M-9	40	6F	St	63.66	62.52	71	14.5	22.5	38.0	8	22	0.400
44-5M-9	44	6W	Al	70.03	68.89	—	14.5	25.5	38.0	8	22	0.170
48-5M-9	48	6W	Al	76.39	75.25	—	14.5	25.5	45.0	8	25	0.182
60-5M-9	60	6W	Al	95.49	94.35	—	14.5	25.5	45.0	8	25	0.230
72-5M-9	72	6W	Al	114.59	113.45	—	14.5	25.5	45.0	8	25	0.270

Al = Aluminium St = Steel Subject to changes due to production.

TIMING BELT PULLEYS

optibelt **ZRS HTD®** TIMING BELT PULLEYS FOR CYLINDRICAL BORES

PROFILE 5M

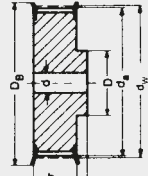

Design 6F

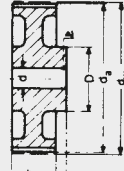

Design 6W

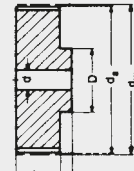

Design 6

Profile 5M – Tooth pitch 5 mm for belt width 15 mm

Designation	Number of teeth	Design	Material	d _w [mm]	d _o [mm]	D _B [mm]	b ₁ [mm]	B [mm]	D [mm]	Pilot bore d [mm]	Finished bore d _{max} [mm]	Weight ≈ [kg]
12-5M-15	12	6F	St	19.10	17.96	25	20.5	26	13.0	4	7	0.034
14-5M-15	14	6F	St	22.28	21.14	25	20.5	26	14.0	6	8	0.046
15-5M-15	15	6F	St	23.87	22.73	28	20.5	26	16.0	6	10	0.056
16-5M-15	16	6F	St	25.46	24.32	28	20.5	26	16.5	6	10	0.064
18-5M-15	18	6F	St	28.65	27.51	32	20.5	26	20.0	6	12	0.086
20-5M-15	20	6F	St	31.83	30.69	36	20.5	26	23.0	6	14	0.112
21-5M-15	21	6F	St	33.42	32.28	38	20.5	26	24.0	6	14	0.130
22-5M-15	22	6F	St	35.01	33.87	38	20.5	26	25.5	6	14	0.140
24-5M-15	24	6F	St	38.20	37.06	42	20.5	28	27.0	6	16	0.180
26-5M-15	26	6F	St	41.38	40.24	44	20.5	28	30.0	6	18	0.220
28-5M-15	28	6F	St	44.56	43.42	48	20.5	28	30.5	6	18	0.250
30-5M-15	30	6F	St	47.75	46.61	51	20.5	28	35.0	6	20	0.300
32-5M-15	32	6F	St	50.93	49.79	54	20.5	28	38.0	8	22	0.350
36-5M-15	36	6F	St	57.30	56.16	60	20.5	28	38.0	8	22	0.426
40-5M-15	40	6F	St	63.66	62.52	71	20.5	28	38.0	8	22	0.520
44-5M-15	44	6W	Al	70.03	68.89	—	20.5	30	38.0	8	22	0.225
48-5M-15	48	6W	Al	76.39	75.25	—	20.5	30	38.0	8	25	0.187
60-5M-15	60	6W	Al	95.49	94.35	—	20.5	30	50.0	8	25	0.305
72-5M-15	72	6W	Al	114.59	113.45	—	20.5	30	50.0	8	25	0.375

Profile 5M – Tooth pitch 5 mm for belt width 25 mm

12-5M-25	12	6F	St	19.10	17.96	25	30	36	13.0	4	7	0.050
14-5M-25	14	6F	St	22.28	21.14	25	30	36	14.0	6	8	0.070
15-5M-25	15	6F	St	23.87	22.73	28	30	36	16.0	6	10	0.080
16-5M-25	16	6F	St	25.46	24.32	28	30	36	16.5	6	10	0.100
18-5M-25	18	6F	St	28.65	27.51	32	30	36	20.0	6	12	0.120
20-5M-25	20	6F	St	31.83	30.69	36	30	36	23.0	6	14	0.160
21-5M-25	21	6F	St	33.42	32.28	38	30	38	24.0	6	14	0.190
22-5M-25	22	6F	St	35.01	33.87	38	30	38	25.5	6	14	0.210
24-5M-25	24	6F	St	38.20	37.06	42	30	38	27.0	6	16	0.250
26-5M-25	26	6F	St	41.38	40.24	44	30	38	30.0	6	18	0.300
28-5M-25	28	6F	St	44.56	43.42	48	30	38	30.5	6	18	0.350
30-5M-25	30	6F	St	47.75	46.61	51	30	38	35.0	6	20	0.420
32-5M-25	32	6F	St	50.93	49.79	54	30	38	38.0	8	22	0.480
36-5M-25	36	6F	St	57.30	56.16	60	30	38	38.0	8	22	0.590
40-5M-25	40	6F	St	63.66	62.52	71	30	38	38.0	8	22	0.740
44-5M-25	44	6W	Al	70.03	68.89	—	30	40	38.0	8	22	0.320
48-5M-25	48	6W	Al	76.39	75.25	—	30	40	38.0	8	25	0.275
60-5M-25	60	6W	Al	95.49	94.35	—	30	40	50.0	8	25	0.435
72-5M-25	72	6W	Al	114.59	113.45	—	30	40	50.0	8	25	0.525

Al = Aluminium St = Steel Subject to changes due to production.

TIMING BELT PULLEYS

optibelt ZRS HTD® TIMING BELT PULLEYS FOR CYLINDRICAL BORES

PROFILE 8M

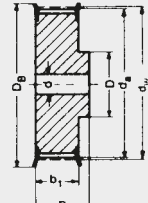

Design 6F

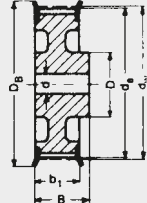

Design 6WF

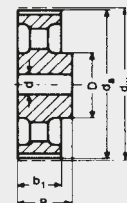

Design 6A

Profile 8M – Tooth pitch 8 mm for belt width 20 mm

Designation	Number of teeth	Design	Material	d_w [mm]	d_o [mm]	D_B [mm]	b_1 [mm]	B [mm]	D [mm]	D_i [mm]	Pilot bore d [mm]	Finished bore d_{max} [mm]	Weight \approx [kg]
22-8M-20	22	6F	St	56.02	54.65	60.0	28	38	43	—	12	30	0.54
24-8M-20	24	6F	St	61.12	59.75	66.0	28	38	45	—	12	30	0.65
26-8M-20	26	6F	St	66.21	64.84	71.0	28	38	50	—	12	35	0.80
28-8M-20	28	6F	St	71.30	69.93	75.0	28	38	50	—	15	35	0.87
30-8M-20	30	6F	St	76.39	75.02	83.0	28	38	55	—	15	35	1.02
32-8M-20	32	6F	St	81.49	80.12	87.0	28	38	60	—	15	40	1.20
34-8M-20	34	6F	St	86.58	85.22	91.0	28	38	70	—	15	45	1.40
36-8M-20	36	6F	St	91.67	90.30	98.5	28	38	70	—	15	45	1.55
38-8M-20	38	6F	St	96.77	95.39	103.0	28	38	75	—	15	45	1.65
40-8M-20	40	6F	GG	101.86	100.49	106.0	28	38	75	—	15	45	1.80
44-8M-20	44	6F	GG	112.05	110.67	119.0	28	38	75	—	15	45	2.10
48-8M-20	48	6F	GG	122.23	120.86	127.0	28	38	75	—	15	45	2.44
56-8M-20	56	6WF	GG	142.60	141.23	148.0	28	38	80	117	15	45	2.60
64-8M-20	64	6WF	GG	162.97	161.60	168.0	28	38	80	137	15	45	2.90
72-8M-20	72	6WF	GG	183.35	181.97	192.0	28	38	80	158	15	45	3.10
80-8M-20	80	6A	GG	203.72	202.35	—	28	38	90	180	15	50	3.80
90-8M-20	90	6A	GG	229.18	227.81	—	28	38	90	204	15	50	4.20
112-8M-20	112	6A	GG	285.21	283.83	—	28	38	90	260	18	50	5.20
144-8M-20	144	6A	GG	366.69	365.32	—	28	38	90	341	20	50	7.50
168-8M-20	168	6A	GG	427.81	426.44	—	28	38	100	402	20	55	10.00
192-8M-20	192	6A	GG	488.92	487.55	—	28	38	100	463	20	55	14.40

Profile 8M – Tooth pitch 8 mm for belt width 30 mm

22-8M-30	22	6F	St	56.02	54.65	60.0	38	48	43	—	12	30	0.69
24-8M-30	24	6F	St	61.12	59.75	66.0	38	48	45	—	12	30	0.84
26-8M-30	26	6F	St	66.21	64.84	71.0	38	48	50	—	12	35	1.00
28-8M-30	28	6F	St	71.30	69.93	75.0	38	48	50	—	15	35	1.12
30-8M-30	30	6F	St	76.39	75.02	83.0	38	48	55	—	15	35	1.32
32-8M-30	32	6F	St	81.49	80.12	87.0	38	48	60	—	15	40	1.50
34-8M-30	34	6F	St	86.58	85.22	91.0	38	48	70	—	15	45	1.80
36-8M-30	36	6F	St	91.67	90.30	98.5	38	48	70	—	15	45	1.99
38-8M-30	38	6F	St	96.77	95.39	103.0	38	48	75	—	15	45	2.27
40-8M-30	40	6F	GG	101.86	100.49	106.0	38	48	75	—	15	45	2.40
44-8M-30	44	6F	GG	112.05	110.67	119.0	38	48	75	—	15	45	2.80
48-8M-30	48	6F	GG	122.23	120.86	127.0	38	48	75	—	15	45	3.20
56-8M-30	56	6WF	GG	142.60	141.23	148.0	38	48	90	117	15	50	3.60
64-8M-30	64	6WF	GG	162.97	161.60	168.0	38	48	90	137	15	50	4.30
72-8M-30	72	6WF	GG	183.35	181.97	192.0	38	48	95	158	15	50	4.80
80-8M-30	80	6A	GG	203.72	202.35	—	38	48	100	180	15	55	5.10
90-8M-30	90	6A	GG	229.18	227.81	—	38	48	100	204	15	55	5.70
112-8M-30	112	6A	GG	285.21	283.83	—	38	48	100	260	18	55	6.80
144-8M-30	144	6A	GG	366.69	365.32	—	38	48	100	341	20	55	9.30
168-8M-30	168	6A	GG	427.81	426.44	—	38	48	100	402	20	55	11.40
192-8M-30	192	6A	GG	488.92	487.55	—	38	48	100	463	20	55	16.00

St = Steel GG = Grey cast iron Subject to changes due to production.

TIMING BELT PULLEYS

optibelt ZRS HTD® TIMING BELT PULLEYS FOR CYLINDRICAL BORES

PROFILE 8M

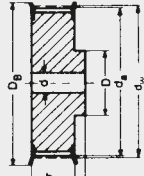

Design 6F

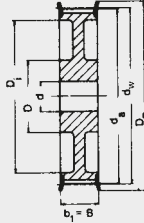

Design 10WF

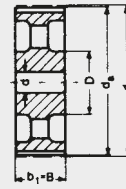

Design 10A

Profile 8M – Tooth pitch 8 mm for belt width 50 mm

Designation	Number of teeth	Design	Material	d_w [mm]	d_o [mm]	D_B [mm]	b_1 [mm]	B [mm]	D [mm]	D_i [mm]	Pilot bore d [mm]	Finished bore d_{max} [mm]	Weight \approx [kg]
22-8M-50	22	6F	St	56.02	54.65	60.0	60	70	43	—	12	30	1.00
24-8M-50	24	6F	St	61.12	59.75	66.0	60	70	45	—	12	30	1.20
26-8M-50	26	6F	St	66.21	64.84	71.0	60	70	50	—	12	35	1.50
28-8M-50	28	6F	St	71.30	70.08	75.0	60	70	50	—	15	35	1.67
30-8M-50	30	6F	St	76.39	75.13	83.0	60	70	55	—	15	35	1.97
32-8M-50	32	6F	St	81.49	80.16	87.0	60	70	60	—	15	40	2.27
34-8M-50	34	6F	St	86.58	85.22	91.0	60	70	70	—	15	45	2.69
36-8M-50	36	6F	St	91.67	90.30	98.5	60	70	70	—	15	45	2.97
38-8M-50	38	6F	St	96.77	95.39	103.0	60	70	75	—	15	45	3.23
40-8M-50	40	6F	GG	101.86	100.49	106.0	60	70	75	—	18	45	3.50
44-8M-50	44	6F	GG	112.05	110.67	119.0	60	70	75	—	18	45	3.90
48-8M-50	48	6F	GG	122.23	120.86	127.0	60	70	80	—	18	45	4.30
56-8M-50	56	10WF	GG	142.60	141.23	148.0	60	60	90	117	18	50	5.00
64-8M-50	64	10WF	GG	162.97	161.60	168.0	60	60	100	137	18	55	5.60
72-8M-50	72	10WF	GG	183.35	181.97	192.0	60	60	100	158	18	55	6.80
80-8M-50	80	10A	GG	203.72	202.35	—	60	60	110	180	18	60	6.90
90-8M-50	90	10A	GG	229.18	227.81	—	60	60	110	204	18	60	8.60
112-8M-50	112	10A	GG	285.21	283.83	—	60	60	110	260	18	60	9.60
144-8M-50	144	10A	GG	366.69	365.32	—	60	60	110	341	20	60	13.80
168-8M-50	168	10A	GG	427.81	426.44	—	60	60	120	402	20	65	16.00
192-8M-50	192	10A	GG	488.92	487.55	—	60	60	130	463	20	70	22.40

Profile 8M – Tooth pitch 8 mm for belt width 85 mm

22-8M-85	22	6F	St	56.02	54.65	60.0	95	105	43	—	12	30	1.55
24-8M-85	24	6F	St	61.12	59.75	66.0	95	105	45	—	12	30	1.90
26-8M-85	26	6F	St	66.21	64.84	71.0	95	105	50	—	12	35	2.25
28-8M-85	28	6F	St	71.30	70.08	75.0	95	105	50	—	15	35	2.55
30-8M-85	30	6F	St	76.39	75.13	83.0	95	105	55	—	15	35	3.00
32-8M-85	32	6F	St	81.49	80.16	87.0	95	105	60	—	15	40	3.57
34-8M-85	34	6F	St	86.58	85.22	91.0	95	105	70	—	15	45	4.00
36-8M-85	36	6F	St	91.67	90.30	98.5	95	105	70	—	15	45	4.50
38-8M-85	38	6F	St	96.77	95.39	103.0	95	105	75	—	15	45	4.90
40-8M-85	40	6F	GG	101.86	100.49	106.0	95	105	75	—	18	45	5.20
44-8M-85	44	6F	GG	112.05	110.67	119.0	95	105	75	—	18	45	6.60
48-8M-85	48	6F	GG	122.23	120.86	127.0	95	105	80	—	18	45	7.60
56-8M-85	56	6F	GG	142.60	141.23	148.0	95	105	80	—	20	50	9.80
64-8M-85	64	10WF	GG	162.97	161.60	168.0	95	95	100	137	20	55	10.40
72-8M-85	72	10WF	GG	183.35	181.97	192.0	95	95	110	158	20	60	11.40
80-8M-85	80	10A	GG	203.72	202.35	—	95	95	110	180	20	60	11.10
90-8M-85	90	10A	GG	229.18	227.81	—	95	95	110	204	20	60	13.20
112-8M-85	112	10A	GG	285.21	283.83	—	95	95	110	260	24	60	16.30
144-8M-85*	144	10A	GG	366.69	365.32	—	95	95	120	341	24	65	21.50
168-8M-85*	168	10A	GG	427.81	426.44	—	95	95	120	402	24	65	26.10
192-8M-85*	192	10A	GG	488.92	487.55	—	95	95	130	463	24	70	30.60

St = Steel GG = Grey cast iron * Not available ex stock Subject to changes due to production.

TIMING BELT PULLEYS

optibelt ZRS HTD® TIMING BELT PULLEYS FOR CYLINDRICAL BORES

PROFILE 14M

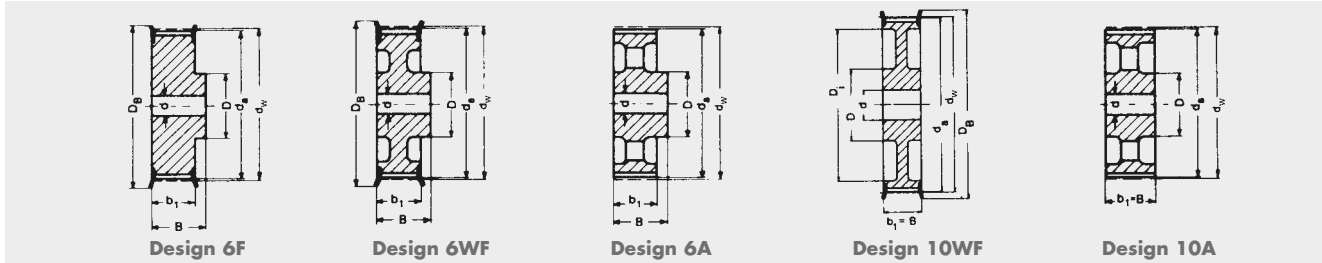

Profile 14M – Tooth pitch 14 mm for belt width 40 mm

Designation	Number of teeth	Design	Material	d_w [mm]	d_o [mm]	D_B [mm]	b_1 [mm]	B [mm]	D [mm]	D_i [mm]	Pilot bore d [mm]	Finished bore d_{max} [mm]	Weight ≈ [kg]
28-14M-40	28	6F	GG	124.78	122.12	127	54	69	100	—	24	60	4.73
29-14M-40	29	6F	GG	129.23	126.57	138	54	69	100	—	24	60	5.09
30-14M-40	30	6F	GG	133.69	130.99	138	54	69	100	—	24	60	5.45
32-14M-40	32	6F	GG	142.60	139.88	154	54	69	100	—	24	70	6.17
34-14M-40	34	6F	GG	151.52	148.79	160	54	69	100	—	24	70	6.88
36-14M-40	36	6F	GG	160.43	157.68	168	54	69	100	—	24	70	7.60
38-14M-40	38	6F	GG	169.34	166.60	183	54	69	120	—	24	70	8.28
40-14M-40	40	6F	GG	178.25	175.49	188	54	69	120	—	24	70	9.26
44-14M-40	44	6F	GG	196.08	193.28	211	54	69	120	—	24	70	10.32
48-14M-40	48	6WF	GG	213.90	211.11	226	54	69	135	172	24	70	11.50
56-14M-40	56	6WF	GG	249.55	246.76	256	54	69	135	207	28	70	13.05
64-14M-40	64	6WF	GG	285.21	282.41	296	54	69	135	242	28	70	14.40
72-14M-40	72	6A	GG	320.86	318.06	—	54	69	135	278	28	70	16.90
80-14M-40	80	6A	GG	356.51	353.71	—	54	69	135	314	28	70	18.50
90-14M-40	90	6A	GG	401.07	398.28	—	54	69	135	358	28	70	20.00
112-14M-40*	112	6A	GG	499.11	496.32	—	54	69	135	456	28	70	26.70
144-14M-40*	144	6A	GG	641.71	638.92	—	54	69	135	600	28	70	35.00
168-14M-40*	168	6A	GG	748.66	745.87	—	54	69	135	706	28	70	44.20
192-14M-40*	192	6A	GG	855.62	852.82	—	54	69	135	813	28	70	52.20
216-14M-40*	216	6A	GG	962.57	959.77	—	54	69	150	920	28	80	60.00

Profile 14M – Tooth pitch 14 mm for belt width 55 mm

28-14M-55	28	6F	GG	124.78	122.12	127	70	85	100	—	24	60	5.60
29-14M-55	29	6F	GG	129.23	126.57	138	70	85	100	—	24	60	6.10
30-14M-55	30	6F	GG	133.69	130.99	138	70	85	100	—	24	60	6.60
32-14M-55	32	6F	GG	142.60	139.88	154	70	85	100	—	24	70	7.60
34-14M-55	34	6F	GG	151.52	148.79	160	70	85	100	—	24	70	8.60
36-14M-55	36	6F	GG	160.43	157.68	168	70	85	100	—	24	70	9.60
38-14M-55	38	6F	GG	169.34	166.60	183	70	85	120	—	24	70	10.80
40-14M-55	40	6F	GG	178.25	175.49	188	70	85	120	—	24	70	11.20
44-14M-55	44	6F	GG	196.08	193.28	211	70	85	120	—	24	70	12.50
48-14M-55	48	10WF	GG	213.90	211.11	226	70	70	135	172	24	70	13.70
56-14M-55	56	10WF	GG	249.55	246.76	256	70	70	135	207	28	70	14.50
64-14M-55	64	10WF	GG	285.21	282.41	296	70	70	135	242	28	70	15.60
72-14M-55	72	10A	GG	320.86	318.06	—	70	70	135	278	28	70	18.50
80-14M-55	80	10A	GG	356.51	353.71	—	70	70	135	314	28	70	20.00
90-14M-55	90	10A	GG	401.07	398.28	—	70	70	135	358	28	70	22.60
112-14M-55*	112	10A	GG	499.11	496.32	—	70	70	135	456	28	70	29.50
144-14M-55*	144	10A	GG	641.71	638.92	—	70	70	135	600	28	70	39.00
168-14M-55*	168	10A	GG	748.66	745.87	—	70	70	135	706	28	70	48.50
192-14M-55*	192	10A	GG	855.62	852.82	—	70	70	135	813	28	70	57.80
216-14M-55*	216	10A	GG	962.57	959.77	—	70	70	150	920	28	80	67.00

GG = Grey cast iron

* Not available ex stock

Subject to changes due to production.

TIMING BELT PULLEYS

optibelt **ZRS HTD®** TIMING BELT PULLEYS FOR CYLINDRICAL BORES

PROFILE 14M

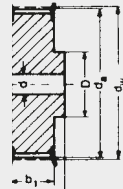

Design 6F

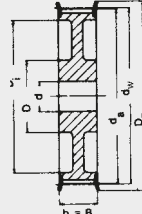

Design 10WF

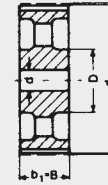

Design 10A

Profile 14M – Tooth pitch 14 mm for belt width 85 mm

Designation	Number of teeth	Design	Material	d_w [mm]	d_o [mm]	D_B [mm]	b_1 [mm]	B [mm]	D [mm]	D_i [mm]	Pilot bore d [mm]	Finished bore d_{max} [mm]	Weight \approx [kg]
28-14M-85	28	6F	GG	124.78	122.12	127	102	117	100	—	24	60	7.70
29-14M-85	29	6F	GG	129.23	126.57	138	102	117	100	—	24	60	8.40
30-14M-85	30	6F	GG	133.69	130.99	138	102	117	100	—	24	60	9.10
32-14M-85	32	6F	GG	142.60	139.88	154	102	117	100	—	24	60	10.50
34-14M-85	34	6F	GG	151.52	148.79	160	102	117	100	—	24	70	11.90
36-14M-85	36	6F	GG	160.43	157.68	168	102	117	100	—	32	70	13.20
38-14M-85	38	6F	GG	169.34	166.60	183	102	117	120	—	32	70	15.15
40-14M-85	40	6F	GG	178.25	175.49	188	102	117	135	—	32	70	17.10
44-14M-85	44	6F	GG	196.08	193.28	211	102	117	135	—	32	70	23.30
48-14M-85	48	6F	GG	213.90	211.11	226	102	117	150	—	32	80	25.00
56-14M-85	56	10WF	GG	249.55	246.76	256	102	102	150	207	32	80	25.00
64-14M-85	64	10WF	GG	285.21	282.41	296	102	102	150	242	32	80	28.20
72-14M-85	72	10A	GG	320.86	318.06	—	102	102	150	278	32	80	28.80
80-14M-85	80	10A	GG	356.51	353.71	—	102	102	150	314	32	80	30.10
90-14M-85	90	10A	GG	401.07	398.28	—	102	102	150	358	32	80	33.00
112-14M-85*	112	10A	GG	499.11	496.32	—	102	102	150	456	32	80	41.80
144-14M-85*	144	10A	GG	641.71	638.92	—	102	102	150	600	32	80	52.40
168-14M-85*	168	10A	GG	748.66	745.87	—	102	102	150	706	32	80	60.30
192-14M-85*	192	10A	GG	855.62	852.82	—	102	102	165	813	32	90	70.20
216-14M-85*	216	10A	GG	962.57	959.77	—	102	102	165	920	32	90	81.00

Profile 14M – Tooth pitch 14 mm for belt width 115 mm

28-14M-115	28	6F	GG	124.78	122.12	127	133	148	100	—	32	60	9.20
29-14M-115	29	6F	GG	129.23	126.57	138	133	148	100	—	32	60	10.20
30-14M-115	30	6F	GG	133.69	130.99	138	133	148	100	—	32	60	11.20
32-14M-115	32	6F	GG	142.60	139.88	154	133	148	100	—	32	60	13.20
34-14M-115	34	6F	GG	151.52	148.79	160	133	148	100	—	32	70	14.80
36-14M-115	36	6F	GG	160.43	157.68	168	133	148	120	—	32	70	16.60
38-14M-115	38	6F	GG	169.34	166.60	183	133	148	120	—	32	70	19.20
40-14M-115	40	6F	GG	178.25	175.49	188	133	148	135	—	32	70	22.10
44-14M-115	44	6F	GG	196.08	193.28	211	133	148	140	—	32	80	28.00
48-14M-115	48	6F	GG	213.90	211.11	226	133	148	150	—	32	80	35.00
56-14M-115	56	6F	GG	249.55	246.76	256	133	148	150	—	32	80	44.20
64-14M-115	64	10WF	GG	285.21	282.41	296	133	133	150	242	32	80	36.80
72-14M-115	72	10A	GG	320.86	318.06	—	133	133	150	278	32	80	36.10
80-14M-115	80	10A	GG	356.51	353.71	—	133	133	150	314	32	80	38.60
90-14M-115	90	10A	GG	401.07	398.28	—	133	133	150	358	32	80	41.00
112-14M-115*	112	10A	GG	499.11	496.32	—	133	133	150	456	32	80	54.40
144-14M-115*	144	10A	GG	641.71	638.92	—	133	133	165	600	32	90	67.80
168-14M-115*	168	10A	GG	748.66	745.87	—	133	133	165	706	32	90	75.80
192-14M-115*	192	10A	GG	855.62	852.82	—	133	133	165	813	32	90	88.30
216-14M-115*	216	10A	GG	962.57	959.77	—	133	133	165	920	32	90	98.00

GG = Grey cast iron

* Not available ex stock

Subject to changes due to production.

TIMING BELT PULLEYS

optibelt ZRS HTD® TIMING BELT PULLEYS FOR CYLINDRICAL BORES PROFILE 14M

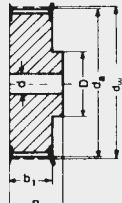

Design 6F

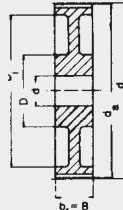

Design 10W

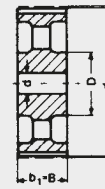

Design 10A

Profile 14M – Tooth pitch 14 mm for belt width 170 mm

Designation	Number of teeth	Design	Material	d_w [mm]	d_o [mm]	D_B [mm]	b_1 [mm]	B [mm]	D [mm]	D_i [mm]	Pilot bore d [mm]	Finished bore d_{max} [mm]	Weight \approx [kg]
28-14M-170*	28	6F	GG	124.78	122.12	127	187	202	100	—	32	60	13.80
29-14M-170*	29	6F	GG	129.23	126.57	138	187	202	100	—	32	60	14.20
30-14M-170*	30	6F	GG	133.69	130.99	138	187	202	100	—	32	60	15.60
32-14M-170*	32	6F	GG	142.60	139.88	154	187	202	100	—	32	60	18.10
34-14M-170*	34	6F	GG	151.52	148.79	160	187	202	100	—	32	60	20.40
36-14M-170*	36	6F	GG	160.43	157.68	168	187	202	120	—	32	70	23.50
38-14M-170*	38	6F	GG	169.34	166.60	183	187	202	135	—	32	70	26.50
40-14M-170*	40	6F	GG	178.25	175.49	188	187	202	140	—	32	85	30.10
44-14M-170*	44	6F	GG	196.08	193.28	211	187	202	160	—	32	85	37.80
48-14M-170*	48	6F	GG	213.90	211.11	226	187	202	160	—	32	85	44.50
56-14M-170*	56	6F	GG	249.55	246.76	256	187	202	160	—	32	85	61.00
64-14M-170*	64	6F	GG	285.21	282.41	296	187	202	180	—	32	100	81.00
72-14M-170*	72	10W	GG	320.86	318.06	—	187	187	180	278	32	100	61.40
80-14M-170*	80	10W	GG	356.51	353.71	—	187	187	180	314	32	100	65.00
90-14M-170*	90	10A	GG	401.07	398.28	—	187	187	180	358	38	100	68.00
112-14M-170*	112	10A	GG	499.11	496.32	—	187	187	200	456	38	110	87.50
144-14M-170*	144	10A	GG	641.71	638.92	—	187	187	220	600	38	120	114.80
168-14M-170*	168	10A	GG	748.66	745.87	—	187	187	220	706	38	120	125.00
192-14M-170*	192	10A	GG	855.62	852.82	—	187	187	220	813	38	120	136.40
216-14M-170*	216	10A	GG	962.57	959.77	—	187	187	220	920	38	120	147.00

GG = Grey cast iron

* Not available ex stock

Subject to changes due to production.

TIMING BELT PULLEYS

optibelt ZRS HTD® TIMING BELT PULLEYS FOR TAPER BUSHES PROFILE 5M

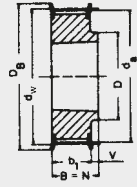

Design 8F

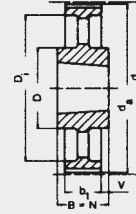

Design 7a

Profile 5M – Tooth pitch 5 mm for belt width 15 mm

Designation	Number of teeth	Design	Material	d_w [mm]	d_a [mm]	D_B [mm]	b_1 [mm]	B [mm]	N [mm]	V [mm]	Z [mm]	D [mm]	D_i [mm]	Taper bush	Weight without bush ≈ [kg]
TB 34-5M-15	34	8F	St	54.11	52.97	57.0	20.5	22	22	1.5	—	43	—	1008	0.190
TB 36-5M-15	36	8F	St	57.30	56.16	60.0	20.5	22	22	1.5	—	44	—	1108	0.200
TB 38-5M-15	38	8F	St	69.48	59.34	66.0	20.5	22	22	1.5	—	48	—	1108	0.250
TB 40-5M-15	40	8F	St	63.66	62.52	71.0	20.5	22	22	1.5	—	52	—	1108	0.310
TB 44-5M-15	44	8F	St	70.03	68.89	75.0	20.5	22	22	1.5	—	54	—	1108	0.400
TB 48-5M-15	48	8F	St	76.39	75.25	83.0	20.5	25	25	4.5	—	64	—	1210	0.450
TB 56-5M-15	56	8F	GG	89.13	87.99	93.0	20.5	25	25	4.5	—	70	—	1210	0.670
TB 64-5M-15	64	8F	GG	101.86	100.72	106.0	20.5	25	25	4.5	—	78	—	1210	0.960
TB 72-5M-15	72	8F	GG	114.59	113.45	119.0	20.5	25	25	4.5	—	90	—	1610	1.190
TB 80-5M-15	80	8F	GG	127.32	126.18	135.0	20.5	25	25	4.5	—	92	—	1610	1.570
TB 90-5M-15	90	7A	GG	143.24	142.10	—	20.5	25	25	2.3	—	92	—	1610	1.147
TB 112-5M-15	112	7A	GG	178.25	177.11	—	20.5	25	25	2.3	—	92	—	1610	1.940
TB 136-5M-15	136	7A	GG	216.45	215.31	—	20.5	32	32	5.8	—	106	—	2012	3.060
TB 150-5M-15	150	7A	GG	238.73	237.59	—	20.5	32	32	5.8	—	106	—	2012	3.900

Taper bush	1008	1108	1210	1610	2012
Bore d_2 [mm] from ... to ...	10-25	10-28	11-32	14-42	14-50

GG = Grey cast iron
St = Steel
Subject to changes due to production.

Bore diameter d_2 see page 91.

TIMING BELT PULLEYS

optibelt **ZRS HTD®** TIMING BELT PULLEYS FOR TAPER BUSHES

PROFILE 8M

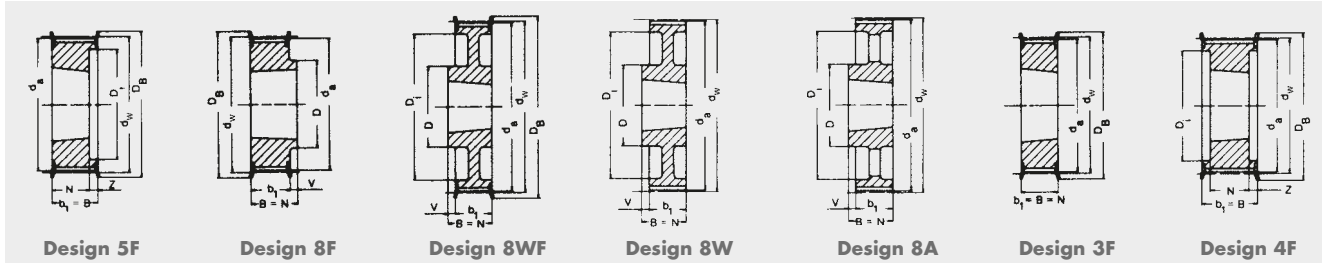

Profile 8M – Tooth pitch 8 mm for belt width 20 mm

Designation	Number of teeth	Design	Material	d_w [mm]	d_a [mm]	D_B [mm]	b_1 [mm]	B [mm]	N [mm]	V [mm]	Z [mm]	D [mm]	D_1 [mm]	Taper bush	Weight without bush ≈ [kg]
TB 22-8M-20	22	5F	GG	56.02	54.65	60.0	28	28	22	—	6	—	41	1008	0.24
TB 24-8M-20	24	5F	GG	61.12	59.75	66.0	28	28	22	—	6	—	42	1108	0.30
TB 26-8M-20	26	5F	GG	66.21	64.84	71.0	28	28	22	—	6	—	46	1108	0.36
TB 28-8M-20	28	5F	GG	71.30	69.93	75.0	28	28	22	—	6	—	50	1108	0.44
TB 30-8M-20	30	5F	GG	76.39	75.02	83.0	28	28	22	—	6	—	58	1108	0.53
TB 32-8M-20	32	5F	GG	81.49	80.12	87.0	28	28	25	—	3	—	62	1610	0.42
TB 34-8M-20	34	5F	GG	86.58	85.22	91.0	28	28	25	—	3	—	65	1610	0.55
TB 36-8M-20	36	5F	GG	91.67	90.30	98.5	28	28	25	—	3	—	68	1610	0.68
TB 38-8M-20	38	5F	GG	96.77	95.39	103.0	28	28	25	—	3	—	72	1610	0.80
TB 40-8M-20	40	5F	GG	101.86	100.49	106.0	28	28	25	—	3	—	76	1610	1.00
TB 44-8M-20	44	8F	GG	112.05	110.67	119.0	28	32	32	4	—	93	—	2012	1.20
TB 48-8M-20	48	8F	GG	122.23	120.86	127.0	28	32	32	4	—	96	—	2012	1.60
TB 56-8M-20	56	8F	GG	142.60	141.23	148.0	28	32	32	4	—	110	—	2012	2.40
TB 64-8M-20	64	8WF	GG	162.97	161.60	168.0	28	32	32	4	—	110	137	2012	2.70
TB 72-8M-20	72	8WF	GG	183.35	181.97	192.0	28	32	32	4	—	110	158	2012	3.30
TB 80-8M-20	80	8W	GG	203.72	202.35	—	28	32	32	4	—	110	180	2012	3.50
TB 90-8M-20	90	8A	GG	229.18	227.81	—	28	32	32	4	—	110	204	2012	3.65

Profile 8M – Tooth pitch 8 mm for belt width 30 mm

TB 22-8M-30	22	5F	GG	56.02	54.65	60.0	38	38	22	—	16	—	41	1008	0.29
TB 24-8M-30	24	5F	GG	61.12	59.75	66.0	38	38	22	—	16	—	42	1108	0.38
TB 26-8M-30	26	5F	GG	66.21	64.84	71.0	38	38	22	—	16	—	46	1108	0.45
TB 28-8M-30	28	5F	St	71.30	69.93	75.0	38	38	25	—	13	—	50	1210	0.50
TB 30-8M-30	30	3F	St	76.39	75.02	83.0	38	38	38	—	—	—	—	1615	0.45
TB 32-8M-30	32	3F	GG	81.49	80.12	87.0	38	38	38	—	—	—	—	1615	0.59
TB 34-8M-30	34	3F	GG	86.58	85.22	91.0	38	38	38	—	—	—	—	1615	0.77
TB 36-8M-30	36	3F	GG	91.67	90.30	98.5	38	38	38	—	—	—	—	1615	0.96
TB 38-8M-30	38	3F	GG	96.77	95.39	103.0	38	38	38	—	—	—	—	1615	1.15
TB 40-8M-30	40	3F	GG	101.86	100.49	106.0	38	38	38	—	—	—	—	1615	1.34
TB 44-8M-30	44	4F	GG	112.05	110.67	119.0	38	38	32	—	3	—	91	2012	1.33
TB 48-8M-30	48	4F	GG	122.23	120.86	127.0	38	38	32	—	3	—	95	2012	1.78
TB 56-8M-30	56	4F	GG	142.60	141.23	148.0	38	38	32	—	3	—	117	2012	3.76
TB 64-8M-30	64	8F	GG	162.97	161.60	168.0	38	45	45	7	—	125	—	2517	4.20
TB 72-8M-30	72	8WF	GG	183.35	181.97	192.0	38	45	45	7	—	125	158	2517	4.30
TB 80-8M-30	80	8W	GG	203.72	202.35	—	38	45	45	7	—	125	180	2517	4.60
TB 90-8M-30	90	8A	GG	229.18	227.81	—	38	45	45	7	—	125	204	2517	5.00
TB 112-8M-30	112	8A	GG	285.21	283.83	—	38	45	45	7	—	125	260	2517	6.20
TB 144-8M-30	144	8A	GG	366.69	365.32	—	38	45	45	7	—	125	341	2517	9.00

Taper bush	1008	1108	1210	1610	1615	2012	2517
Bore d_2 [mm] from ... to ...	10-25	10-28	11-32	14-42	14-42	14-50	16-60

GG = Grey cast iron
St = Steel
Subject to changes due to production.

Bore diameter d_2 see page 91.

TIMING BELT PULLEYS

optibelt ZRS HTD® TIMING BELT PULLEYS FOR TAPER BUSHES

PROFILE 8M

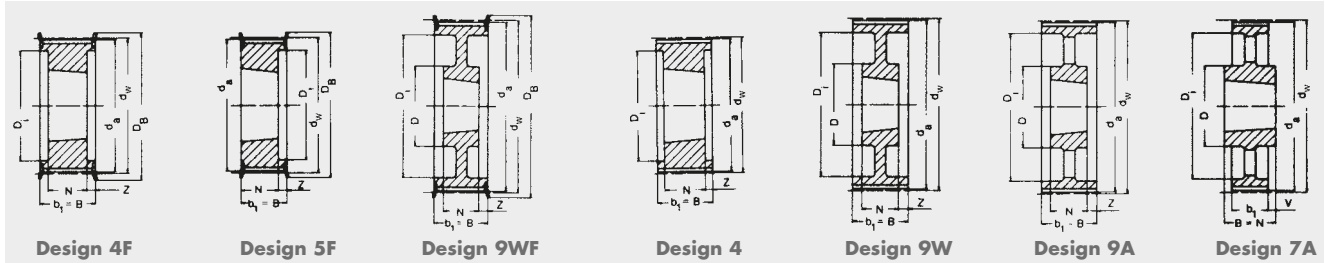

Profile 8M – Tooth pitch 8 mm for belt width 50 mm

Designation	Number of teeth	Design	Material	d_w [mm]	d_a [mm]	D_B [mm]	b_1 [mm]	B [mm]	N [mm]	V [mm]	Z [mm]	D [mm]	D_1 [mm]	Taper bush	Weight without bush ≈ [kg]
TB 28-8M-50	28	5F	St	71.30	69.93	75.0	60	60	25	—	35.0	—	50	1210	0.60
TB 30-8M-50	30	5F	St	76.39	75.02	83.0	60	60	38	—	22.0	—	58	1615	0.65
TB 32-8M-50	32	5F	GG	81.49	80.12	87.0	60	60	38	—	22.0	—	62	1615	0.82
TB 34-8M-50	34	5F	GG	86.58	85.22	91.0	60	60	38	—	22.0	—	65	1615	1.06
TB 36-8M-50	36	5F	GG	91.67	90.30	98.5	60	60	38	—	22.0	—	68	1615	1.30
TB 38-8M-50	38	5F	GG	96.77	95.39	103.0	60	60	38	—	22.0	—	72	1615	1.60
TB 40-8M-50	40	4F	GG	101.86	100.49	106.0	60	60	32	—	14.0	—	82	2012	1.71
TB 44-8M-50	44	4F	GG	112.05	110.67	119.0	60	60	32	—	14.0	—	91	2012	1.78
TB 48-8M-50	48	4F	GG	122.23	120.86	127.0	60	60	32	—	14.0	—	95	2012	2.30
TB 56-8M-50	56	4F	GG	142.60	141.23	148.0	60	60	45	—	7.5	—	116	2517	3.40
TB 64-8M-50	64	4F	GG	162.97	161.60	168.0	60	60	45	—	7.5	—	137	2517	5.00
TB 72-8M-50	72	9WF	GG	183.35	181.97	192.0	60	60	45	—	7.5	125	158	2517	6.70
TB 80-8M-50	80	4	GG	203.72	202.35	—	60	60	51	—	4.5	—	180	3020	8.80
TB 90-8M-50	90	9W	GG	229.18	227.81	—	60	60	51	—	4.5	170	204	3020	10.00
TB 112-8M-50	112	9W	GG	285.21	283.83	—	60	60	51	—	4.5	170	260	3020	12.00
TB 144-8M-50	144	9A	GG	366.69	365.32	—	60	60	51	—	4.5	170	341	3020	15.20
TB 168-8M-50	168	7A	GG	427.81	426.44	—	60	65	65	—	2.5	170	402	3525	16.40
TB 192-8M-50	192	7A	GG	488.92	487.55	—	60	65	65	—	2.5	170	460	3525	21.80

Profile 8M – Tooth pitch 8 mm for belt width 85 mm

TB 34-8M-85	34	4F	GG	86.58	85.22	91.0	95	95	38	—	28.5	—	65	1615	1.43
TB 36-8M-85	36	4F	GG	91.67	90.30	98.5	95	95	38	—	28.5	—	68	1615	1.87
TB 38-8M-85	38	4F	GG	96.77	95.39	103.0	95	95	38	—	28.5	—	72	1615	2.20
TB 40-8M-85	40	4F	GG	101.86	100.49	106.0	95	95	32	—	31.5	—	82	2012	1.78
TB 44-8M-85	44	4F	GG	112.05	110.67	119.0	95	95	32	—	31.5	—	91	2012	2.30
TB 48-8M-85	48	4F	GG	122.23	120.86	127.0	95	95	45	—	25.0	—	100	2517	2.66
TB 56-8M-85	56	4F	GG	142.60	141.23	148.0	95	95	45	—	25.0	—	117	2517	4.45
TB 64-8M-85	64	4F	GG	162.97	161.60	168.0	95	95	45	—	25.0	—	137	2517	6.20
TB 72-8M-85	72	4F	GG	183.35	181.97	192.0	95	95	51	—	22.0	—	158	3020	8.00
TB 80-8M-85	80	4	GG	203.72	202.35	—	95	95	51	—	22.0	—	180	3020	10.00
TB 90-8M-85	90	9W	GG	229.18	227.81	—	95	95	51	—	22.0	170	204	3020	10.80
TB 112-8M-85	112	9W	GG	285.21	283.83	—	95	95	51	—	22.0	170	260	3020	15.00
TB 144-8M-85	144	9A	GG	366.69	365.32	—	95	95	76	—	15.0	170	341	3525	20.00
TB 168-8M-85	168	9A	GG	427.81	426.44	—	95	95	76	—	15.0	170	402	3525	23.00
TB 192-8M-85	192	9A	GG	488.92	487.55	—	95	95	76	—	15.0	170	460	3525	28.50

Taper bush	1210	1615	2012	2517	3020	3525
Bore d_2 [mm] from ... to ...	11-32	14-42	14-50	16-60	25-75	35-90

GG = Grey cast iron
St = Steel
Subject to changes due to production.

Bore diameter d_2 see page 91.

TIMING BELT PULLEYS

optibelt ZRS HTD® TIMING BELT PULLEYS FOR TAPER BUSHES PROFILE 14M

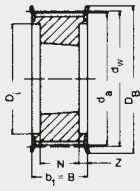

Design 4F

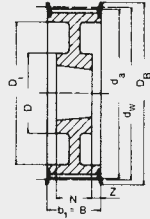

Design 9WF

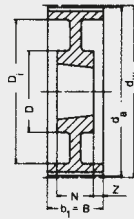

Design 9W

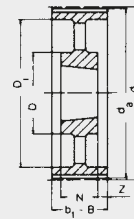

Design 9A

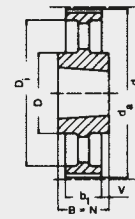

Design 7A

Profile 14M – Tooth pitch 14 mm for belt width 40 mm

Designation	Number of teeth	Design	Material	d_w [mm]	d_a [mm]	D_B [mm]	b_1 [mm]	B [mm]	N [mm]	V [mm]	Z [mm]	D [mm]	D_1 [mm]	Taper bush	Weight without bush ≈ [kg]
TB 28-14M-40	28	4F	GG	124.78	122.12	127	54	54	32	—	11.0	—	98	2012	2.00
TB 29-14M-40	29	4F	GG	129.23	126.57	138	54	54	32	—	11.0	—	100	2012	2.38
TB 30-14M-40	30	4F	GG	133.69	130.99	138	54	54	32	—	11.0	—	100	2012	2.65
TB 32-14M-40	32	4F	GG	142.60	139.88	154	54	54	32	—	11.0	—	104	2012	3.40
TB 34-14M-40	34	4F	GG	151.52	148.79	160	54	54	45	—	4.5	—	110	2517	3.87
TB 36-14M-40	36	4F	GG	160.43	157.68	168	54	54	45	—	4.5	—	120	2517	4.80
TB 38-14M-40	38	4F	GG	169.34	166.60	183	54	54	45	—	4.5	—	130	2517	5.40
TB 40-14M-40	40	4F	GG	178.25	175.49	188	54	54	45	—	4.5	—	138	2517	6.00
TB 44-14M-40	44	4F	GG	196.08	193.28	211	54	54	51	—	1.5	—	155	3020	7.80
TB 48-14M-40	48	4F	GG	213.90	211.11	226	54	54	51	—	1.5	—	170	3020	9.40
TB 56-14M-40	56	9WF	GG	249.55	246.76	256	54	54	51	—	1.5	170	208	3020	10.80
TB 64-14M-40	64	9WF	GG	285.21	282.41	296	54	54	51	—	1.5	170	242	3020	13.40
TB 72-14M-40	72	9W	GG	320.86	318.06	—	54	54	51	—	1.5	170	280	3020	15.20
TB 80-14M-40	80	9A	GG	356.51	353.71	—	54	54	51	—	1.5	170	315	3020	16.00
TB 90-14M-40	90	9A	GG	401.07	398.28	—	54	54	51	—	1.5	170	360	3020	17.80
TB 112-14M-40	112	9A	GG	499.11	496.32	—	54	54	51	—	1.5	170	457	3020	25.60
TB 144-14M-40	144	9A	GG	641.71	638.92	—	54	54	51	—	1.5	170	600	3020	32.00
TB 168-14M-40	168	9A	GG	748.66	745.87	—	54	54	51	—	1.5	170	706	3020	44.00
TB 192-14M-40	192	9A	GG	855.62	852.82	—	54	54	51	—	1.5	170	813	3020	49.00
TB 216-14M-40	216	9A	GG	962.57	959.77	—	54	54	51	—	1.5	170	920	3020	55.00

Profile 14M – Tooth pitch 14 mm for belt width 55 mm

TB 28-14M-55	28	4F	GG	124.78	122.12	127	70	70	32	—	19.0	—	98	2012	2.20
TB 29-14M-55	29	4F	GG	129.23	126.57	138	70	70	32	—	19.0	—	100	2012	2.74
TB 30-14M-55	30	4F	GG	133.69	130.99	138	70	70	45	—	12.5	—	100	2517	2.70
TB 32-14M-55	32	4F	GG	142.60	139.88	154	70	70	45	—	12.5	—	108	2517	3.66
TB 34-14M-55	34	4F	GG	151.52	148.79	160	70	70	45	—	12.5	—	110	2517	4.55
TB 36-14M-55	36	4F	GG	160.43	157.68	168	70	70	45	—	12.5	—	120	2517	5.20
TB 38-14M-55	38	4F	GG	169.34	166.60	183	70	70	45	—	12.5	—	130	2517	6.20
TB 40-14M-55	40	4F	GG	178.25	175.49	188	70	70	45	—	12.5	—	138	2517	7.00
TB 44-14M-55	44	4F	GG	196.08	193.28	211	70	70	51	—	9.5	—	155	3020	8.60
TB 48-14M-55	48	4F	GG	213.90	211.11	226	70	70	51	—	9.5	—	170	3020	10.40
TB 56-14M-55	56	9WF	GG	249.55	246.76	256	70	70	51	—	9.5	170	208	3020	12.00
TB 64-14M-55	64	9WF	GG	285.21	282.41	296	70	70	51	—	9.5	170	242	3020	14.50
TB 72-14M-55	72	9W	GG	320.86	318.06	—	70	70	51	—	9.5	170	280	3020	16.20
TB 80-14M-55	80	9A	GG	356.51	353.71	—	70	70	51	—	9.5	170	315	3020	17.50
TB 90-14M-55	90	9A	GG	401.07	398.28	—	70	70	51	—	9.5	170	360	3020	20.10
TB 112-14M-55	112	9A	GG	499.11	496.32	—	70	70	51	—	9.5	170	457	3020	28.40
TB 144-14M-55	144	9A	GG	641.71	638.92	—	70	70	51	—	9.5	170	600	3020	36.20
TB 168-14M-55	168	9A	GG	748.66	745.87	—	70	70	51	—	9.5	170	706	3020	49.00
TB 192-14M-55	192	9A	GG	855.62	852.82	—	70	70	51	—	9.5	170	813	3020	53.00
TB 216-14M-55	216	7A	GG	962.57	959.77	—	70	89	89	9.5	—	190	920	3535	65.80

Taper bush	2012	2517	3020	3535
Bore d_2 [mm] from ... to ...	14-50	16-60	25-75	35-90

GG = Grey cast iron
Subject to changes due to production.

Bore diameter d_2 see page 91.

TIMING BELT PULLEYS

optibelt **ZRS HTD®** TIMING BELT PULLEYS FOR TAPER BUSHES

PROFILE 14M

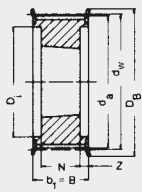

Design 4F

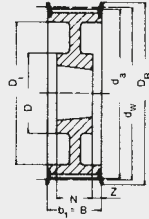

Design 9WF

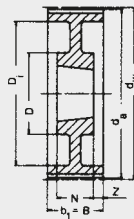

Design 9W

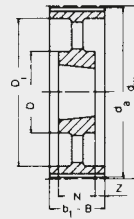

Design 9A

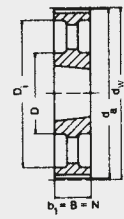

Design 3A

Profile 14M – Tooth pitch 14 mm for belt width 85 mm

Designation	Number of teeth	Design	Material	d_w [mm]	d_a [mm]	D_B [mm]	b_1 [mm]	B [mm]	N [mm]	V [mm]	Z [mm]	D [mm]	D_1 [mm]	Taper bush	Weight without bush ≈ [kg]
TB 28-14M-85	28	4F	GG	124.78	122.12	127	102	102	45	—	28.5	—	98	2517	2.70
TB 29-14M-85	29	4F	GG	129.23	126.57	138	102	102	45	—	28.5	—	100	2517	3.40
TB 30-14M-85	30	4F	GG	133.69	130.99	138	102	102	45	—	28.5	—	100	2517	3.75
TB 32-14M-85	32	4F	GG	142.60	139.88	154	102	102	45	—	28.5	—	108	2517	4.80
TB 34-14M-85	34	4F	GG	151.52	148.79	160	102	102	45	—	28.5	—	110	2517	6.00
TB 36-14M-85	36	4F	GG	160.43	157.68	168	102	102	51	—	25.5	—	120	3020	5.80
TB 38-14M-85	38	4F	GG	169.34	166.60	183	102	102	51	—	25.5	—	130	3020	6.80
TB 40-14M-85	40	4F	GG	178.25	175.49	188	102	102	51	—	25.5	—	138	3020	8.00
TB 44-14M-85	44	4F	GG	196.08	193.28	211	102	102	76	—	13.0	—	155	3030	11.80
TB 48-14M-85	48	4F	GG	213.90	211.11	226	102	102	76	—	13.0	—	170	3030	15.10
TB 56-14M-85	56	4F	GG	249.55	246.76	256	102	102	65	—	18.5	190	210	3525	19.00
TB 64-14M-85	64	9WF	GG	285.21	282.41	296	102	102	65	—	18.5	190	242	3525	23.00
TB 72-14M-85	72	9W	GG	320.86	318.06	—	102	102	65	—	18.5	190	280	3525	25.00
TB 80-14M-85	80	9A	GG	356.51	353.71	—	102	102	65	—	18.5	190	315	3525	26.00
TB 90-14M-85	90	9A	GG	401.07	398.28	—	102	102	65	—	18.5	190	360	3525	27.80
TB 112-14M-85	112	9A	GG	499.11	496.32	—	102	102	65	—	18.5	190	457	3525	36.50
TB 144-14M-85	144	9A	GG	641.71	638.92	—	102	102	65	—	18.5	190	600	3525	48.00
TB 168-14M-85	168	9A	GG	748.66	745.87	—	102	102	65	—	18.5	190	706	3525	60.00
TB 192-14M-85	192	3A	GG	855.62	852.82	—	102	102	102	—	—	230	813	4040	86.00
TB 216-14M-85	216	3A	GG	962.57	959.77	—	102	102	102	—	—	230	920	4040	91.50

Profile 14M – Tooth pitch 14 mm for belt width 115 mm

TB 28-14M-115	28	4F	GG	124.78	122.12	127	133	133	45	—	44.0	—	98	2517	3.77
TB 29-14M-115	29	4F	GG	129.23	126.57	138	133	133	45	—	44.0	—	100	2517	4.00
TB 30-14M-115	30	4F	GG	133.69	130.99	138	133	133	45	—	44.0	—	100	2517	5.00
TB 32-14M-115	32	4F	GG	142.60	139.88	154	133	133	45	—	44.0	—	108	2517	6.80
TB 34-14M-115	34	4F	GG	151.52	148.79	160	133	133	45	—	44.0	—	110	2517	6.80
TB 36-14M-115	36	4F	GG	160.43	157.68	168	133	133	51	—	41.0	—	120	3020	7.00
TB 38-14M-115	38	4F	GG	169.34	166.60	183	133	133	51	—	41.0	—	130	3020	8.40
TB 40-14M-115	40	4F	GG	178.25	175.49	188	133	133	51	—	41.0	—	140	3020	9.20
TB 44-14M-115	44	4F	GG	196.08	193.28	211	133	133	76	—	28.5	—	155	3030	14.00
TB 48-14M-115	48	4F	GG	213.90	211.11	226	133	133	76	—	28.5	—	170	3030	17.10
TB 56-14M-115	56	4F	GG	249.55	246.76	256	133	133	89	—	22.0	—	210	3535	24.80
TB 64-14M-115	64	9WF	GG	285.21	282.41	296	133	133	89	—	22.0	190	242	3535	27.00
TB 72-14M-115	72	9W	GG	320.86	318.06	—	133	133	89	—	22.0	190	280	3535	29.00
TB 80-14M-115	80	9A	GG	356.51	353.71	—	133	133	89	—	22.0	190	315	3535	32.00
TB 90-14M-115	90	9A	GG	401.07	398.28	—	133	133	89	—	22.0	190	360	3535	36.50
TB 112-14M-115	112	9A	GG	499.11	496.32	—	133	133	89	—	22.0	190	457	3535	46.00
TB 144-14M-115	144	9A	GG	641.71	638.92	—	133	133	102	—	15.5	230	600	4040	68.00
TB 168-14M-115	168	9A	GG	748.66	745.87	—	133	133	102	—	15.5	230	706	4040	82.60
TB 192-14M-115	192	9A	GG	855.62	852.82	—	133	133	102	—	15.5	230	813	4040	96.00
TB 216-14M-115	216	9A	GG	962.57	959.77	—	133	133	102	—	15.5	230	920	4040	107.00

Taper bush	2517	3020	3030	3525	3535	4040
Bore d_2 [mm] from ... to ...	16-60	25-75	35-75	35-90	35-90	40-100

GG = Grey cast iron
Subject to changes due to production.

Bore diameter d_2 see page 91.

TIMING BELT PULLEYS

optibelt ZRS HTD® TIMING BELT PULLEYS FOR TAPER BUSHES PROFILE 14M

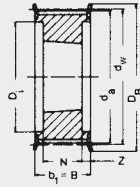

Design 4F

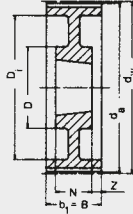

Design 9W

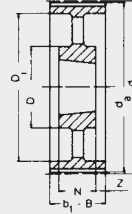

Design 9A

Profile 14M – Tooth pitch 14 mm for belt width 170 mm

Designation	Number of teeth	Design	Material	d _w [mm]	d _a [mm]	D _B [mm]	b ₁ [mm]	B [mm]	N [mm]	V [mm]	Z [mm]	D [mm]	D ₁ [mm]	Taper bush	Weight without bush ≈ [kg]
TB 38-14M-170*	38	4F	GG	169.34	166.60	183	187	187	76	—	55.5	—	130	3030	11.70
TB 40-14M-170*	40	4F	GG	178.25	175.49	188	187	187	76	—	55.5	—	140	3030	13.00
TB 44-14M-170*	44	4F	GG	196.08	193.28	211	187	187	89	—	49.0	—	155	3535	15.00
TB 48-14M-170*	48	4F	GG	213.90	211.11	226	187	187	89	—	49.0	—	175	3535	19.00
TB 56-14M-170*	56	4F	GG	249.55	246.76	256	187	187	89	—	49.0	—	210	3535	28.50
TB 64-14M-170*	64	4F	GG	285.21	282.41	296	187	187	102	—	42.5	—	240	4040	41.00
TB 72-14M-170*	72	9W	GG	320.86	318.06	—	187	187	102	—	42.5	230	280	4040	46.90
TB 80-14M-170*	80	9W	GG	356.51	353.71	—	187	187	102	—	42.5	230	315	4040	48.00
TB 90-14M-170*	90	9A	GG	401.07	398.28	—	187	187	102	—	42.5	230	360	4040	52.50
TB 112-14M-170*	112	9A	GG	499.11	496.32	—	187	187	127	—	30.0	265	457	5050	74.50
TB 144-14M-170*	144	9A	GG	641.71	638.92	—	187	187	127	—	30.0	265	600	5050	91.00
TB 168-14M-170*	168	9A	GG	748.66	745.87	—	187	187	127	—	30.0	265	706	5050	116.00
TB 192-14M-170*	192	9A	GG	855.62	852.82	—	187	187	127	—	30.0	265	813	5050	134.00
TB 216-14M-170*	216	9A	GG	962.57	959.77	—	187	187	127	—	30.0	265	920	5050	146.50

Taper bush	3030	3535	4040	5050
Bore d ₂ [mm] from ... to ...	35-75	35-90	40-100	70-125

GG = Grey cast iron
Subject to changes due to production.
* Not available ex stock

Bore diameter d₂ see page 91.

TIMING BELT PULLEYS

optibelt TB TAPER BUSHES



Taper bushes with metric bore, keyway to DIN 6885 part 1																
	Taper bush										Material: EN-GJL-200 – DIN EN 1561					
	1008	1108	1210	1215	1310	1610	1615	2012	2517	3020	3030	3525	3535	4040	4545	5050
Bore diameter d ₂ [mm]	10	10	11	11	14	14	14	14	16	25	35	35	35	40	55	70
	11	11	12	12	16	16	16	16	18	28	38	38	38	42	60	75
	12	12	14	14	18	18	18	18	19	30	40	40	40	45	65	80
	14	14	16	16	19	19	19	19	20	32	42	42	42	48	70	85
	15	15	18	18	20	20	20	20	22	35	45	45	45	50	75	90
	16	16	19	19	22	22	22	22	24	38	48	48	48	55	80	95
	18	18	20	20	24	24	24	24	25	40	50	50	50	60	85	100
	19	19	22	22	25	25	25	25	28	42	55	55	55	65	90	105
	20	20	24	24	28	28	28	28	30	45	60	60	60	70	95	110
	22	22	25	25	30	30	30	30	32	48	65	65	65	75	100	115
	24▲	24	28	28	32	32	32	32	35	50	70	70	70	80	105	120
	25▲	25	30	30	35	35	35	35	38	55	75	75	75	85	110	125
		28▲	32	32		38	38	38	40	60		80	80	90		
						40	40	40	42	65		85	85	95		
						42▲	42▲	42	45	70		90	90	100		
								45	48	75						
								48	50							
								50	55							
								60								
Hexagon socket screws [inch]	1/4 x 1/2	1/4 x 1/2	3/8 x 5/8	3/8 x 5/8	3/8 x 5/8	3/8 x 5/8	3/8 x 5/8	7/16 x 7/8	1/2 x 1	5/8 x 1 1/4	5/8 x 1 1/4	1/2 x 1 1/2	1/2 x 1 1/2	5/8 x 1 3/4	3/4 x 2	7/8 x 2 1/4
Tightening torque [Nm]	5.7	5.7	20	20	20	20	20	31	49	92	92	115	115	172	195	275
Bush length [mm]	22.3	22.3	25.4	38.1	25.4	25.4	38.1	31.8	44.5	50.8	76.2	63.5	88.9	101.6	114.3	127.0
Weight at d _{2 min} [≈ kg]	0.12	0.16	0.28	0.39	0.32	0.41	0.60	0.75	1.06	2.50	3.75	3.90	5.13	7.68	12.70	15.17

From 3525: Hexagon head screw ▲ These bores have shallow keyways.

Shallow keyways for taper bushes

Bore diameter d ₂ [mm]	Keyway width b [mm]	Keyway depth t ₂ [mm]	Bore diameter d ₂ [mm]	Keyway width b [mm]	Keyway depth t ₂ [mm]
24	8	2.0	28	8	2.0
25	8	1.3	42	12	2.2

Taper bushes with inch bore, keyway to British Standard BS 46 part 1																
	Taper bush										Material: EN-GJL-200 – DIN EN 1561					
	1008	1108	1210	1215	1310	1610	1615	2012	2517	3020	3030	3525	3535	4040	4545	5050
Bore diameter d ₂ [inch]	3/8*	3/8*	1/2	5/8*	1/2*	1/2	1/2	5/8*	3/4	1 1/4	1 1/4	1 1/2	1 1/2	1 3/4*	2 1/4*	3*
	1/2	1/2	5/8	3/4	5/8*	5/8	5/8	3/4	7/8	1 3/8	1 3/8	1 5/8	1 5/8	1 7/8*	2 3/8*	3 1/4*
	5/8	5/8	3/4	7/8	3/4*	3/4	3/4	7/8	1	1 1/2	1 1/2	1 3/4	1 3/4	2*	2 1/2*	3 1/2*
	3/4	3/4	7/8	1	7/8*	7/8	7/8*	1	1 1/8	1 5/8	1 5/8	1 7/8	1 7/8	2 1/8*	2 3/4*	3 3/4*
	7/8	7/8	1	1 1/8	1*	1	1	1 1/8	1 1/4	1 3/4*	1 3/4*	2	2	2 1/4*	2 7/8*	4*
	1▲	1	1 1/8	1 1/4	1 1/8	1 1/8	1 1/8	1 1/4	1 3/8	1 7/8	1 7/8	2 1/8	2 1/8	2 3/8*	3*	4 1/4*
		1 1/8▲*	1 1/4		1 1/4	1 1/4	1 1/4	1 3/8	1 1/2	2	2	2 1/4	2 1/4	2 1/2*	3 1/4*	4 1/2*
					1 3/8	1 3/8	1 1/2	1 5/8	1 5/8	2 1/8*	2 1/8*	2 3/8	2 3/8	2 5/8*	3 3/8*	4 3/4*
					1 1/2	1 1/2	1 5/8	1 3/4	1 7/8	2 1/4	2 1/4	2 1/2	2 1/2	2 3/4*	3 1/2*	5▲*
					1 5/8	1 5/8▲*	1 3/4	1 7/8	2 3/8	2 3/8	2 3/8	2 5/8	2 5/8	2 7/8*	3 3/4*	
							1 7/8	2	2 1/2	2 1/2	2 3/4	2 3/4	2 3/4	3*	4*	
							2	2 1/8	2 5/8	2 5/8*	2 7/8	2 7/8	2 7/8	3 1/8*	4 1/4▲*	
								2 1/4	2 3/4	2 3/4*	3	3	3	3 1/4*	4 1/2▲*	
								2 3/8	2 7/8	2 7/8	3	3	3 1/8	3 3/8*		
								2 1/2	3	3 1/4	3 1/4	3 1/4	3 1/2*	3 1/2*		
												3 3/8	3 3/8	3 3/4▲*		
												3 1/2▲	3 1/2▲	4▲*		
Hexagon socket screws [inch]	1/4 x 1/2	1/4 x 1/2	3/8 x 5/8	3/8 x 5/8	3/8 x 5/8	3/8 x 5/8	3/8 x 5/8	7/16 x 7/8	1/2 x 1	5/8 x 1 1/4	5/8 x 1 1/4	1/2 x 1 1/2	1/2 x 1 1/2	5/8 x 1 3/4	3/4 x 2	7/8 x 2 1/4
Tightening torque [Nm]	5.7	5.7	20	20	20	20	20	31	49	92	92	115	115	172	195	275
Bush length [mm]	22.3	22.3	25.4	38.1	25.4	25.4	38.1	31.8	44.5	50.8	76.2	63.5	88.9	101.6	114.3	127.0
Weight at d _{2 min} [≈ kg]	0.12	0.16	0.28	0.39	0.32	0.41	0.60	0.75	1.06	2.50	3.75	3.90	5.13	7.68	12.70	15.17

From 3525: Hexagon head screw * Not available ex stock ▲ These bores have shallow keyways.

TIMING BELT PULLEYS

RECOMMENDED SPECIAL DESIGNS

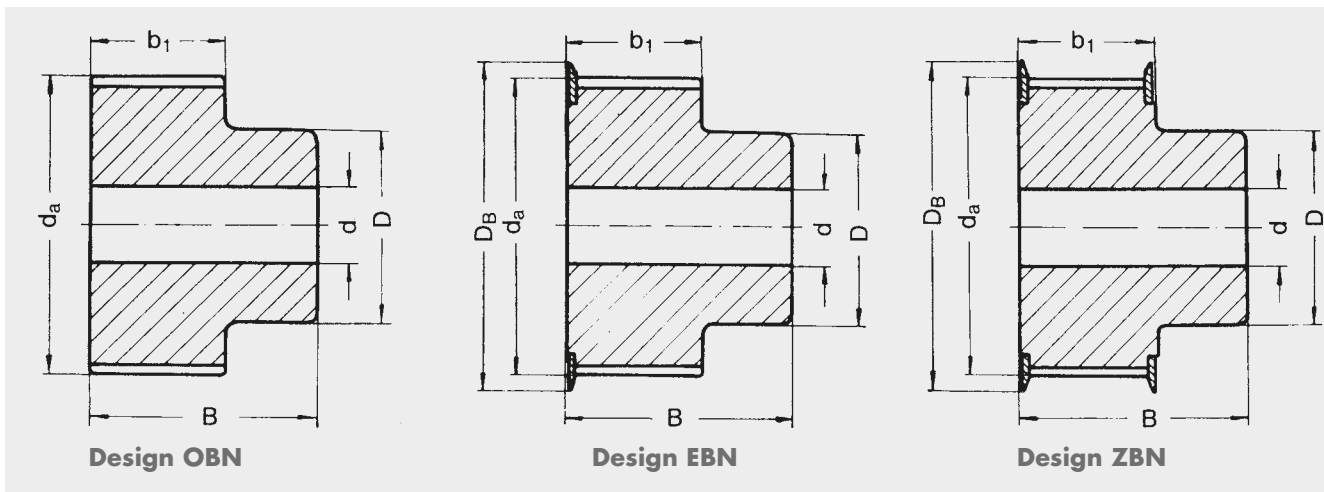
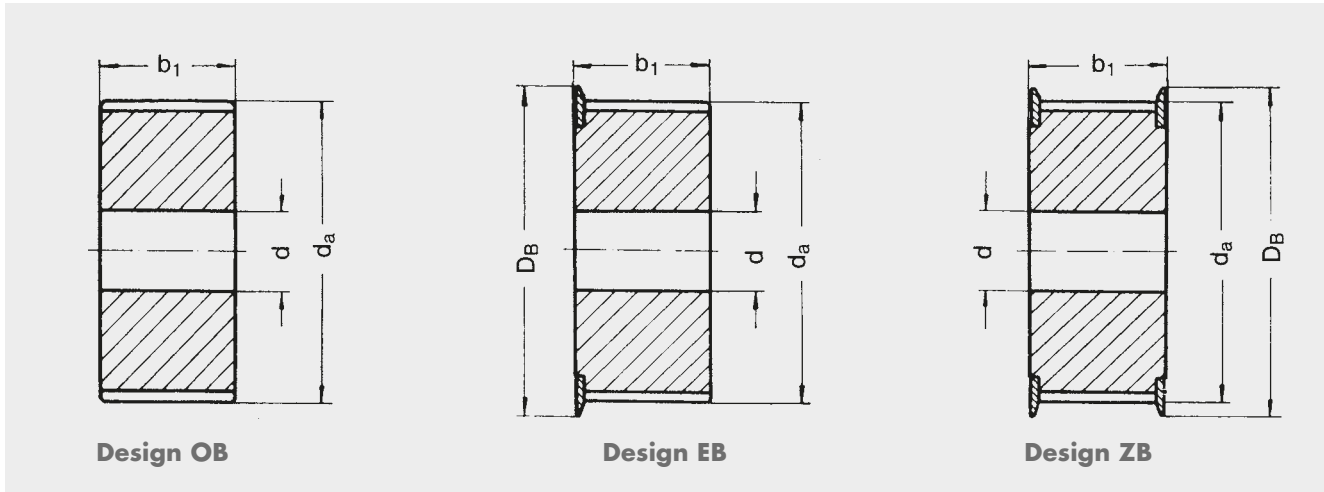

Materials

Steel, grey cast iron, aluminium;
other materials available on request
Do NOT use cast iron for speeds > 30 m/s anymore!

Bores

All timing belt pulleys are pilot bored.
On request they can be finish bored according to DIN H7.

Explanation of the abbreviations

- OB = without flanges
- EB = one flange
- ZB = two flanges
- OBN = without flanges, with hub
- EBN = one flange, with hub
- ZBN = two flanges, with hub

TIMING BELT PULLEYS

DIMENSIONS AND TOLERANCES



Allowed deviation in tooth pitch

The allowed tolerances in the distance between two grooves and the sum of the deviations within a 90° arc on a pulley are given in the following table. These tolerances are the distance between the equivalent points on the right or the left side respectively of two adjacent grooves.

Outside diameter d_a [mm]	Allowed deviation in the tooth pitch [mm]	
	between two consecutive grooves	sum within a 90° arc
≤ 25	0.03	0.06
$> 25 \leq 50$	0.03	0.09
$> 50 \leq 100$	0.03	0.10
$> 100 \leq 175$	0.03	0.13
$> 175 \leq 300$	0.03	0.15
$> 300 \leq 500$	0.03	0.18
> 500	0.03	0.20

Allowed deviation of the outside diameter

Outside diameter d_a [mm]	Allowed deviation [mm]
≤ 25	+ 0.05 0
$> 25 \leq 50$	+ 0.07 0
$> 50 \leq 100$	+ 0.10 0
$> 100 \leq 175$	+ 0.13 0
$> 175 \leq 300$	+ 0.15 0
$> 300 \leq 500$	+ 0.18 0
> 500	+ 0.20 0

Pulley width

Profile	Pulley width designation [mm]	Pulley width [mm]	Smallest allowed pulley width	
			with flanges b_f^* [mm]	without flanges b [mm]
3 M	6	6	7	9
	9	9	10	12
	15	15	17	19
5 M	9	9	10	12
	15	15	17	19
	25	25	27	29
8 M	20	20	22	26
	30	30	34	38
	50	50	54	58
	85	85	90	94
14 M	40	40	47	54
	55	55	63	70
	85	85	95	102
	115	115	126	133
	170	170	180	187

* b_f = pulley width between the flanges

Note

The minimum width b for pulleys without flanges can be reduced, if there is no side wobble or run out; however, it may not fall below the minimum width b_f for pulleys with flanges.

Axial run-out tolerance

Outside diameter range [mm]	Maximum total fluctuation [mm]
≤ 100	0.10
$> 100 \leq 250$	0.01 mm per 10 mm outside diameter
> 250	0.25 mm + 0.0005 mm per mm outside diameter above 250.00 mm

Tolerance of eccentricity

Outside diameter [mm]	Maximum total fluctuation [mm]
≤ 200	0.10
> 200	0.0005 mm per 10 mm outside diameter, but not exceeding the tolerance for the outside diameter

TIMING BELT PULLEYS

DIMENSIONS AND TOLERANCES



Balancing

Processed steel pulleys need no balancing if the rim speed is below 30 m/s. Grey cast iron pulleys for medium speeds should be statically balanced according to the following table:

Profile	Number of teeth	Static balancing [N]
3M	all	0.04
5M	all	0.08
8M	≤ 130	0.08
	> 130	0.16
14M	≤ 72	0.08
	> 72	0.16

Pulleys running at rim speeds exceeding of 30 m/s require dynamic balancing up to $1.8 \cdot 10^{-5}$ Nm.

Parallelism

The teeth should run parallel to the axis of the bore with a tolerance of not more than 0.001 mm per millimetre width.

Conicity

The conicity may not exceed 0.001 mm per millimetre of the width of the driving face and at the same time should not exceed the permitted outside diameter tolerances.

TIMING BELT PULLEYS

optibelt ZRS DIMENSIONS AND TOLERANCES



optibelt ZR standard timing belt pulleys

optibelt ZRS standard timing belt pulleys are manufactured according to the standards of ISO 5294 using a hobbing process. This ensures minimum tooth clearance and a precise tooth engagement. The following figures and tables show the dimensions and tolerances of the optibelt ZRS standard timing belt pulleys.

Hobbing Cutter for Pulleys with Involute Tooth Patterns according to ISO 5294

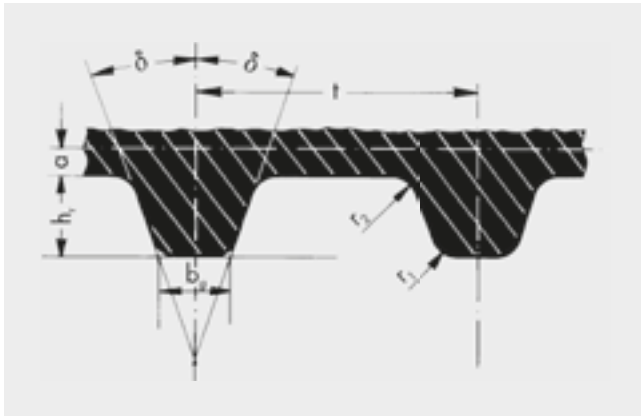

Table 38
Dimensions and permitted deviations of the hobbing cutter for pulleys with involute tooth patterns according to ISO 5294

Profile	Number of teeth	t [mm] ± 0.003	δ [°] ± 0.12	h_r [mm] $+ 0.05$ 0	b_g [mm] $+ 0.05$ 0	r_1 [mm] ± 0.03	r_2 [mm] ± 0.03	2α [mm]
MXL	≥ 10	2.032	20	0.66	0.84	0.25	0.13	0.508
XL	≥ 10	5.080	25	1.40	1.27	0.61	0.61	0.508
L	≥ 10	9.525	20	2.13	3.10	0.86	0.53	0.762
H	14-19	12.700	20	2.59	4.24	1.47	1.04	1.372
	>						1.42	
XH	≥ 18	22.225	20	6.88	7.59	2.01	1.93	2.794
XXH	≥ 18	31.750	20	10.29	11.61	2.69	2.82	3.048

Table 39
Tolerances for the outside diameter of the rough-machined blanks

Outside diameter d_a [mm]	Tolerances [mm]
≤ 100	+ 0.3 + 0.2
$> 100 \leq 200$	+ 0.4 + 0.3
$> 200 \leq 300$	+ 0.5 + 0.4
$> 300 \leq 500$	+ 0.7 + 0.5
> 500	+ 0.9 + 0.7

Allowed tolerances in tooth pitch

The allowed tolerances in the distance between two teeth and the sum of the deviations within a 90° arc on a pulley are given in the following table. These tolerances are the distance between the equivalent points on the right or the left side respectively of two adjacent teeth.

Table 40

Outside diameter d_a [mm]	Allowed deviation of the teeth distance [mm]	
	between two consecutive teeth [mm]	sum within a 90° arc [mm]
≤ 25.40	0.03	0.05
$> 25.40 \leq 50.80$	0.03	0.08
$> 50.80 \leq 101.60$	0.03	0.10
$> 101.60 \leq 177.80$	0.03	0.13
$> 177.80 \leq 304.80$	0.03	0.15
$> 304.80 \leq 508.00$	0.03	0.18
> 508.00	0.03	0.20

Table 41
Pulley widths according to ISO 5294

Profile	Pulley width designation [mm]	Nominal pulley width [mm]	Smallest pulley width	
			with flanges b_f [mm]	without flanges b'_f [mm]
MXL	012	3.2	3.8	5.6
	019	4.8	5.3	7.1
	025	6.4	7.1	8.9
XL	025	6.4	7.1	8.9
	031	7.9	8.6	10.4
	037	9.5	10.4	12.2
L	050	12.7	14.0	17.0
	075	19.1	20.3	23.3
	100	25.4	26.7	29.7
H	075	19.1	20.3	24.6
	100	25.4	26.7	31.2
	150	38.1	39.4	43.9
	200	50.8	52.8	57.3
	300	76.2	79.0	83.5
XH	200	50.8	56.6	62.6
	300	76.2	83.8	89.8
	400	101.6	110.7	116.7
XXH	200	50.8	56.6	64.1
	300	76.2	83.8	91.3
	400	101.6	110.7	118.2
	500	127.0	137.7	145.2

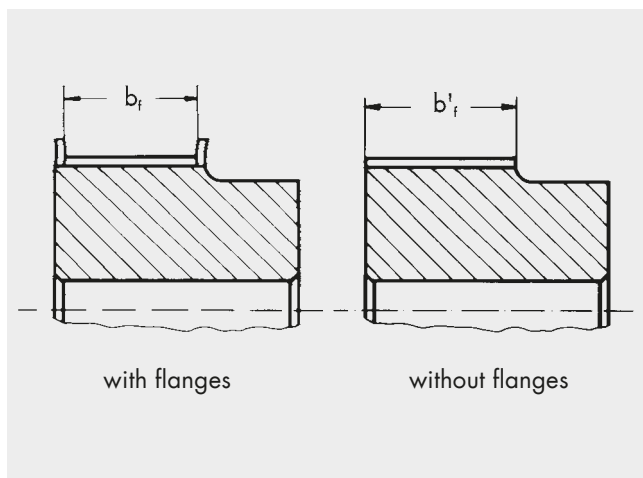

Note
The minimum width for pulleys without flanges b'_f can be reduced if the drive alignment can be guaranteed; however it may not be less than the value b_f given for pulleys with flanges.

Table 42
Permitted tolerances for the outside diameter to ISO 5294

Outside diameter d_o [mm]	Allowed tolerances [mm]
≤ 25.40	+ 0.05 0
$> 25.40 \leq 50.80$	+ 0.08 0
$> 50.80 \leq 101.60$	+ 0.10 0
$> 101.60 \leq 177.80$	+ 0.13 0
$> 177.80 \leq 304.80$	+ 0.15 0
$> 304.80 \leq 508.00$	+ 0.18 0
> 508.00	+ 0.20 0

Table 43
Minimum flange height according to ISO 5294

Profile	Minimum flange height [mm]
MXL	0.5
XL	1.0
L	1.5
H	2.0
XH	4.8
XXH	6.1

Flange dimensions according to ISO 5294

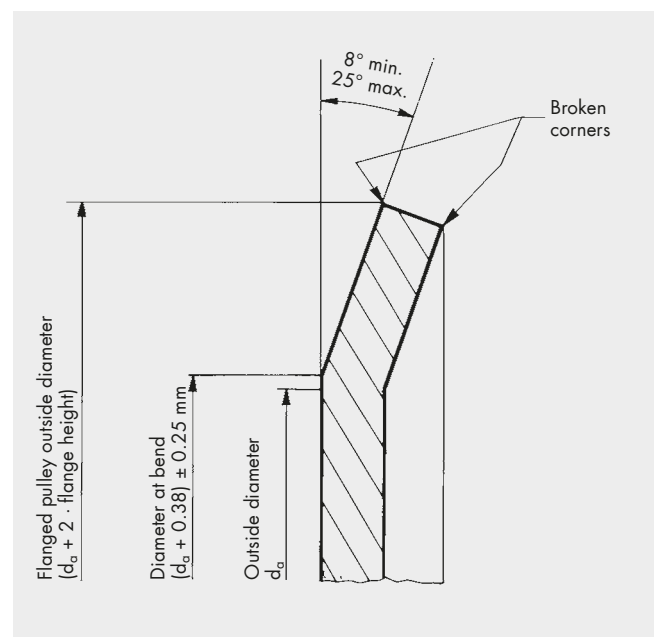

TIMING BELT PULLEYS

optibelt ZRS DIMENSIONS AND TOLERANCES



Table 44
Axial circular run-out according to ISO 5294

Outside diameter d_o [mm]	Maximum total fluctuation [mm]
≤ 101.60	0.10
$> 101.60 \leq 254.00$	0.01 mm per 10 mm outside diameter
> 254.00	0.25 mm + 0.0005 mm per mm outside diameter above 254.00 mm

Please also consult software:
optibelt CAP drive calculation
and data
optibelt CAD 2D/3D
online at: www.optibelt.com

Table 45
Radial circular run-out according to ISO 5294

Outside diameter d_o [mm]	Maximum total fluctuation [mm]
≤ 203.20	0.13
> 203.20	0.13 mm + 0.0005 mm per outside diameter above 203.20 mm

Pulleys running at rim speeds exceeding 30 m/s require dynamic balancing up to $1.8 \cdot 10^{-5}$ Nm.

Parallelism

The teeth should run parallel to the axis of the bore with a tolerance of less than 0.001 mm per millimetre width.

Conicity

The conicity may not exceed 0.001 mm per millimetre of the width of the driving face and at the same time should not exceed the permitted outside diameter tolerances given in table 44.

TIMING BELT PULLEYS

optibelt ZRS PITCH AND OUTSIDE DIAMETER [MM]



Table 46

Number of teeth	Profile MXL		Profile XL		Profile L		Profile H		Profile XH		Profile XXH	
	Pitch	Outside diameter	Pitch	Outside diameter	Pitch	Outside diameter	Pitch	Outside diameter	Pitch	Outside diameter	Pitch	Outside diameter
10	6.47	5.96	16.17	15.66	30.32	29.56						
11	7.11	6.61	17.79	17.28	33.35	32.59						
12	7.76	7.25	19.40	18.89	36.38	35.62						
13	8.41	7.90	21.02	20.51	39.41	38.65						
14	9.06	8.55	22.64	22.13	42.45	41.69	56.60	55.23				
15	9.70	9.19	24.26	23.75	45.48	44.72	60.64	59.27				
16	10.35	9.84	25.87	25.36	48.51	47.75	64.68	63.31				
17	11.00	10.49	27.49	26.98	51.54	50.78	68.72	67.35				
18	11.64	11.14	29.11	28.60	54.57	53.81	72.77	71.40	127.34	124.55	181.91	178.87
19	12.29	11.78	30.72	30.21	57.61	56.85	76.81	75.44	134.41	131.62	192.02	188.98
20	12.94	12.43	32.34	31.83	60.64	59.88	80.85	79.48	141.49	138.70	202.13	199.09
21	13.58	13.08	33.96	33.45	63.67	62.91	84.89	83.52	148.56	145.77	212.23	209.18
22	14.23	13.72	35.57	35.06	66.70	65.94	88.94	87.57	155.64	152.83	222.34	219.29
23	14.88	14.37	37.19	36.68	69.73	68.97	92.98	91.61	162.71	159.92	232.45	229.40
24	15.52	15.02	38.81	38.30	72.77	72.01	97.02	95.65	169.79	167.00	242.55	239.50
25	16.17	15.66	40.43	39.92	75.80	75.04	101.06	99.69	176.86	174.07	252.66	249.61
26	16.82	16.31	42.04	41.53	78.83	78.07	105.11	103.74	183.94	181.13	262.77	259.72
27	17.46	16.96	43.67	43.16	81.86	81.10	109.15	107.78	191.01	188.22	272.87	269.82
28	18.11	17.60	45.28	44.77	84.89	84.13	113.19	111.82	198.08	195.29	282.98	279.93
29	18.75	18.24	46.89	46.38	87.93	87.17	117.23	115.86	205.16	202.37	293.08	290.03
30	19.40	18.90	48.51	48.00	90.96	90.20	121.28	119.91	212.23	209.44	303.19	300.14
31	20.04	19.53	50.13	49.62	93.99	93.23	125.32	123.95	219.31	216.52	313.30	310.25
32	20.70	20.19	51.74	51.23	97.02	96.26	129.36	127.99	226.38	223.59	323.40	320.35
33	21.34	20.83	53.36	52.85	100.05	99.29	133.40	132.03	233.46	230.67	333.51	330.46
34	21.99	21.49	54.98	54.47	103.08	102.32	137.45	136.08	240.53	237.74	343.62	340.57
35	22.63	22.12	56.60	56.09	106.12	105.36	141.49	140.12	247.61	244.82	353.72	350.67
36	23.29	22.78	58.21	57.70	109.15	108.39	145.53	144.16	254.68	251.89	363.83	360.78
37	23.93	23.42	59.83	59.32	112.18	111.42	149.57	148.20	261.75	258.95	373.94	370.89
38	24.59	24.08	61.45	60.94	115.21	114.45	153.62	152.25	268.83	266.04	384.04	380.99
39	25.22	24.71	63.06	62.55	118.24	117.48	157.66	156.29	275.90	273.11	394.15	391.10
40	25.87	25.36	64.68	64.17	121.28	120.52	161.70	160.33	282.98	280.19	404.25	401.21
41	26.52	26.00	66.30	65.79	124.31	123.55	165.74	164.37	290.05	287.26	414.36	411.31
42	27.18	26.67	67.91	67.40	127.34	126.58	169.79	168.42	297.13	294.34	424.47	421.42
43	27.81	27.30	69.53	69.02	130.37	129.61	173.83	172.46	304.20	301.41	434.57	431.52
44	28.45	27.94	71.15	70.64	133.40	132.64	177.87	176.50	311.28	308.48	444.68	441.63
45	29.11	28.60	72.77	72.26	136.44	135.68	181.91	180.54	318.35	315.54	454.79	451.74
46	29.74	29.23	74.38	73.87	139.47	138.71	185.96	184.59	325.42	322.63	464.89	461.84
47	30.40	29.89	76.00	75.49	142.50	141.74	190.00	188.63	332.50	329.69	474.95	471.95
48	31.05	30.54	77.62	77.11	145.53	144.76	194.04	192.67	339.57	336.78	485.11	482.07
49	31.70	31.19	79.23	78.72	148.56	147.80	198.08	196.71	346.65	343.86	495.21	492.16
50	32.33	31.83	80.85	80.34	151.60	150.84	202.13	200.76	353.72	350.93	505.32	502.27
51	33.00	32.50	82.47	81.96	154.63	153.87	206.17	204.80	360.80	358.01	515.42	512.37
52	33.63	33.12	84.08	83.57	157.66	156.90	210.21	208.84	367.87	365.07	525.53	522.48
53	34.29	33.79	85.70	85.19	160.69	159.93	214.25	212.88	374.95	372.16	535.64	532.59
54	34.94	34.43	87.32	86.81	163.72	162.96	218.30	216.93	382.02	379.22	545.74	542.70
55	35.60	35.09	88.94	88.43	166.75	165.99	222.34	220.97	389.09	386.30	555.85	552.81
56	36.22	35.72	90.55	90.04	169.79	169.03	226.38	225.01	396.17	393.38	565.96	562.91
57	36.86	36.36	92.17	91.66	172.82	172.06	230.42	229.14	403.24	400.45	576.06	573.01
58	37.52	37.02	93.79	93.28	175.85	175.09	234.47	233.10	410.32	407.53	586.17	583.12
59	38.16	37.65	95.40	94.89	178.88	178.12	238.51	237.14	417.39	414.60	596.27	593.22
60	38.81	38.30	97.02	96.51	181.91	181.15	242.55	241.18	424.47	421.67	606.38	603.33
61	39.46	38.95	98.64	98.13	184.95	184.19	246.59	245.22	431.54	428.75	616.49	613.44
62	40.10	39.59	100.25	99.74	187.98	187.22	250.64	249.27	438.62	435.83	626.59	623.54
63	40.73	40.22	101.87	101.36	191.01	190.25	254.68	253.31	445.69	442.90	636.70	633.65
64	41.39	40.89	103.49	102.98	194.04	193.28	258.72	257.35	452.76	449.96	646.81	643.76
65	42.04	41.53	105.11	104.60	197.07	196.31	262.77	261.40	459.84	457.05	656.91	653.86
66	42.69	42.18	106.72	106.21	200.11	199.35	266.81	265.44	466.91	464.12	667.02	663.97
67	43.32	42.82	108.34	107.83	203.14	202.38	270.85	269.48	473.99	471.20	677.13	674.08
68	43.97	43.46	109.96	109.45	206.17	205.41	274.89	273.52	481.06	478.27	687.23	684.18
69	44.62	44.11	111.57	111.06	209.20	208.44	278.94	277.57	488.14	485.34	697.34	694.29
70	45.29	44.78	113.19	112.68	212.23	211.47	282.98	281.61	495.21	492.42	707.44	704.39
71	45.92	45.41	114.81	114.30	215.27	214.51	287.02	285.65	502.29	499.49	717.55	714.50
72	46.57	46.06	116.43	115.92	218.30	217.54	291.06	289.69	509.36	506.57	727.66	724.61
73	47.22	46.71	118.04	117.53	221.33	220.57	295.11	293.74	516.43	513.64	737.76	734.71
74	47.85	47.39	119.66	119.15	224.36	223.60	299.15	297.78	523.51	520.72	747.87	744.82

TIMING BELT PULLEYS

optibelt ZRS PITCH AND OUTSIDE DIAMETER [MM]



Table 47

Number of teeth	Profile MXL		Profile XL		Profile L		Profile H		Profile XH		Profile XXH	
	Pitch diameter	Outside diameter	Pitch diameter	Outside diameter	Pitch diameter	Outside diameter	Pitch diameter	Outside diameter	Pitch diameter	Outside diameter	Pitch diameter	Outside diameter
75	48.51	48.00	121.28	120.77	227.39	226.63	303.19	301.82	530.58	527.79	757.98	754.93
76	49.15	48.64	122.89	122.38	230.42	229.66	307.23	305.86	537.66	534.87	768.08	765.03
77	49.81	49.30	124.51	124.00	233.46	232.70	311.28	309.91	544.73	541.93	778.19	775.14
78	50.43	49.93	126.13	125.62	236.49	235.73	315.32	313.95	551.81	549.02	788.30	785.25
79	51.10	50.60	127.74	127.23	239.52	238.76	319.36	317.99	558.88	556.08	798.40	795.35
80	51.73	51.22	129.36	128.85	242.55	241.79	323.40	322.03	565.96	563.17	808.51	805.46
81	52.39	51.88	130.98	130.47	245.58	244.82	327.45	326.08	573.03	570.24	818.61	815.56
82	53.04	52.54	132.60	132.09	248.62	247.86	331.49	330.12	580.10	577.31	828.72	825.67
83	53.68	53.18	134.21	133.70	251.65	250.89	335.53	334.16	587.18	584.39	838.83	835.78
84	54.32	53.81	135.83	135.32	254.68	253.92	339.57	338.20	594.25	591.46	848.93	845.88
85	55.00	54.49	137.45	136.94	257.71	256.95	343.62	342.25	601.33	598.54	859.04	855.99
86	55.62	55.11	139.06	138.55	260.74	259.98	347.66	346.29	608.40	605.61	869.15	866.10
87	56.25	55.73	140.68	140.17	263.78	263.02	351.70	350.33	615.48	612.69	879.25	876.20
88	56.93	56.41	142.30	141.79	266.81	266.05	355.74	354.37	622.55	619.76	889.36	886.31
89	57.55	57.04	143.91	143.40	269.84	269.08	359.79	358.42	629.63	626.84	899.46	896.42
90	58.20	57.69	145.53	145.02	272.87	272.11	363.83	362.46	636.70	633.91	909.57	906.53
91	58.85	58.34	147.15	146.64	275.90	275.14	367.87	366.50	643.71	640.98	919.68	916.64
92	59.51	59.00	148.77	148.26	278.94	278.18	371.91	370.54	650.85	648.06	929.78	926.73
93	60.14	59.62	150.38	149.87	281.97	281.21	375.96	374.59	657.92	655.13	939.89	935.54
94	60.81	60.30	152.00	151.49	285.00	284.24	380.00	378.63	665.00	662.20	949.99	946.94
95	61.44	60.93	153.62	153.11	288.03	287.27	384.04	382.67	672.07	669.28	960.10	957.05
96	62.08	61.57	155.23	154.72	291.06	290.30	388.08	386.71	679.15	676.35	970.21	967.16
97	62.74	62.23	156.85	156.34	294.09	293.33	392.13	390.76	686.22	683.43	980.32	977.27
98	63.40	62.88	158.47	157.96	297.13	296.37	396.17	394.80	693.30	690.51	990.42	987.37
99	64.01	63.50	160.08	159.57	300.16	299.40	400.21	398.84	700.37	697.58	1000.53	997.48
100	64.67	64.16	161.70	161.19	303.19	302.43	404.25	402.88	707.44	704.65	1010.63	1007.58
101	65.32	64.81	163.32	162.81	306.22	305.46	408.30	406.93	714.52	711.73	1020.74	1017.69
102	65.95	65.44	164.94	164.43	309.25	308.49	412.34	410.97	721.59	718.80	1030.85	1027.80
103	66.62	66.12	166.55	166.04	312.29	311.53	416.38	415.01	728.67	725.88	1040.95	1037.90
104	67.25	66.74	168.17	167.66	315.32	314.56	420.42	419.05	735.74	732.94	1051.06	1048.01
105	67.91	67.39	169.79	169.28	318.35	317.59	424.47	423.10	742.82	740.03	1061.17	1058.12
106	68.55	68.04	171.40	170.89	321.38	320.62	428.51	427.14	749.89	747.10	1071.27	1068.22
107	69.20	68.70	173.02	172.51	324.41	323.65	432.55	431.18	756.97	754.18	1081.38	1078.33
108	69.86	69.34	174.64	174.13	327.45	326.69	436.59	435.22	764.04	761.25	1091.49	1088.44
109	70.51	69.99	176.25	175.74	330.48	329.72	440.64	439.27	771.11	768.32	1101.59	1098.54
110	71.13	70.63	177.87	177.36	333.50	332.74	444.68	443.31	778.19	775.40	1111.70	1108.65
111	71.81	71.31	179.49	178.98	336.54	335.78	448.72	447.35	785.26	782.47	1121.80	1118.75
112	72.44	71.93	181.11	180.60	339.57	338.81	452.76	451.39	792.34	789.53	1131.91	1128.86
113	73.09	72.58	182.72	182.21	342.61	341.85	456.81	455.44	799.41	796.62	1142.02	1138.97
114	73.75	73.34	184.34	183.83	345.64	344.88	460.85	459.48	806.49	803.70	1152.12	1149.07
115	74.37	73.86	185.96	185.45	348.67	347.91	464.89	463.52	813.56	810.77	1162.23	1159.18
116	75.02	74.51	187.57	187.06	351.70	350.94	468.93	467.56	820.64	817.83	1172.34	1169.29
117	75.68	75.17	189.19	188.68	354.73	353.97	472.98	471.61	827.71	824.92	1182.44	1179.39
118	76.33	75.82	190.81	190.30	357.76	357.00	477.02	475.65	834.78	831.99	1192.55	1189.50
119	76.95	76.43	192.42	191.91	360.80	360.04	481.06	479.69	841.86	839.06	1202.66	1199.62
120	77.63	77.11	194.04	193.53	363.83	363.07	485.10	483.73	848.93	846.14	1212.76	1209.71

TIMING BELT PULLEYS

optibelt **ZRS** PROFILE XL, L FOR CYLINDRICAL BORES

STANDARD TIMING BELT PULLEYS

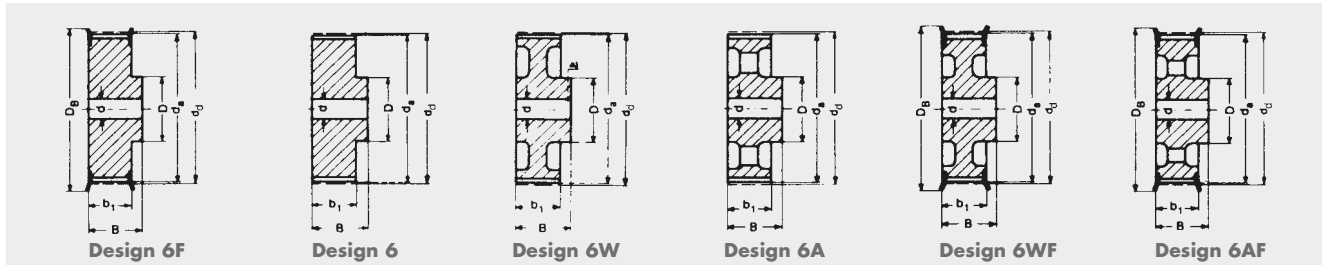

Profile XL – tooth pitch 5.08 mm and width code 025, 031, 037 – belt width 6.4 mm, 7.9 mm, 9.5 mm

Belt designation	Number of teeth	Design	Material	d _w [mm]	d _o [mm]	D _B [mm]	b ₁ [mm]	B [mm]	D [mm]	Pilot bore d [mm]	Finished bore d _{max} [mm]	Setscrew	Weight approx. [kg]
10 XL 037	10	6F	St	16.17	15.66	23	14.3	19.8	9.5	5	6.4	M3	0.02
11 XL 037	11	6F	St	17.79	17.28	23	14.3	19.8	9.5	5	6.4	M3	0.02
12 XL 037	12	6F	St	19.40	18.89	25	14.3	19.8	12.7	5	7.9	M3	0.03
14 XL 037	14	6F	St	22.64	22.13	28	14.3	19.8	14.3	6	9.5	M4	0.04
15 XL 037	15	6F	St	24.26	23.75	28	14.3	19.8	15.9	6	11.1	M4	0.04
16 XL 037	16	6F	St	25.87	25.36	32	14.3	19.8	17.5	6	12.7	M4	0.05
18 XL 037	18	6F	St	29.11	28.60	36	14.3	19.8	19.0	6	14.3	M4	0.06
20 XL 037	20	6F	St	32.34	31.83	38	14.3	22.2	23.8	6	17.5	M4	0.08
21 XL 037	21	6F	St	33.96	33.45	38	14.3	22.2	23.8	6	17.5	M4	0.09
22 XL 037	22	6F	St	35.57	35.06	42	14.3	22.2	25.4	6	19.1	M4	0.10
24 XL 037	24	6F	St	38.81	38.30	44	14.3	22.2	27.0	6	20.6	M4	0.12
26 XL 037	26	6F	St	42.04	41.53	48	14.3	22.2	30.0	6	23.0	M4	0.14
28 XL 037	28	6F	St	45.28	44.77	51	14.3	22.2	30.2	6	23.0	M4	0.16
30 XL 037	30	6F	St	48.51	48.00	54	14.3	22.2	34.9	6	23.0	M4	0.19
32 XL 037	32	6	Al	51.74	51.23	—	14.3	25.4	38.0	8	23.0	M4	0.11
36 XL 037	36	6	Al	58.21	57.70	—	14.3	25.4	38.0	8	23.0	M4	0.13
40 XL 037	40	6	Al	64.68	64.17	—	14.3	25.4	38.0	8	23.0	M4	0.17
42 XL 037	42	6W	Al	67.91	67.40	—	14.3	25.4	38.0	8	23.0	M4	0.13
44 XL 037	44	6W	Al	71.15	70.64	—	14.3	25.4	38.0	8	23.0	M4	0.15
48 XL 037	48	6W	Al	77.62	77.11	—	14.3	25.4	38.0	8	23.0	M4	0.16
60 XL 037	60	6A	Al	97.02	96.51	—	14.3	25.4	38.0	8	23.0	M4	0.18
72 XL 037	72	6A	Al	116.43	115.92	—	14.3	25.4	38.0	8	23.0	M4	0.23

Profile L – tooth pitch 9.525 mm and width code 050 – belt width 12.7 mm

10 L 050	10	6F	St	30.32	29.56	36	19	26	22	6	13	—	0.11
12 L 050	12	6F	St	36.38	35.62	42	19	26	28	6	17	—	0.19
13 L 050	13	6F	St	39.41	38.65	44	19	26	30	6	19	—	0.21
14 L 050	14	6F	St	42.45	41.68	48	19	26	33	8	20	—	0.25
15 L 050	15	6F	St	45.48	44.72	51	19	26	36	8	23	—	0.30
16 L 050	16	6F	St	48.51	47.75	54	19	26	38	8	23	—	0.33
17 L 050	17	6F	St	51.54	50.78	57	19	26	40	10	24	—	0.36
18 L 050	18	6F	St	54.57	53.81	60	19	26	40	10	24	—	0.41
19 L 050	19	6F	St	57.61	56.84	60	19	26	40	10	24	—	0.45
20 L 050	20	6F	St	60.64	59.88	66	19	26	46	10	28	—	0.50
21 L 050	21	6F	St	63.67	62.91	71	19	26	46	10	28	—	0.55
22 L 050	22	6F	St	66.70	65.94	75	19	26	50	10	30	—	0.62
24 L 050	24	6F	St	72.77	72.00	79	19	26	50	12	30	—	0.68
26 L 050	26	6F	St	78.83	78.07	87	19	26	50	12	30	—	0.82
28 L 050	28	6F	St	84.89	84.13	91	19	26	50	12	30	—	0.92
30 L 050	30	6F	St	90.96	90.20	97	19	26	50	12	30	—	1.10
32 L 050	32	6F	St	97.02	96.26	103	19	26	50	12	30	—	1.20
36 L 050	36	6WF	GG	109.15	108.24	115	19	26	50	12	30	—	1.00
40 L 050	40	6WF	GG	121.28	120.51	127	19	26	50	12	30	—	1.10
44 L 050	44	6AF	GG	133.40	132.64	140	19	26	50	12	30	—	1.20
48 L 050	48	6AF	GG	145.53	144.77	152	19	26	50	12	30	—	1.30
60 L 050	60	6A	GG	181.91	181.15	—	19	28	50	15	30	—	1.30
72 L 050	72	6A	GG	218.30	217.53	—	19	28	50	15	30	—	1.70
84 L 050	84	6A	GG	254.68	253.92	—	19	28	50	15	30	—	1.90

Al = Aluminium St = Steel GG = Grey cast iron Subject to changes due to production.

TIMING BELT PULLEYS

optibelt ZRS PROFILE L FOR CYLINDRICAL BORES

STANDARD TIMING BELT PULLEYS

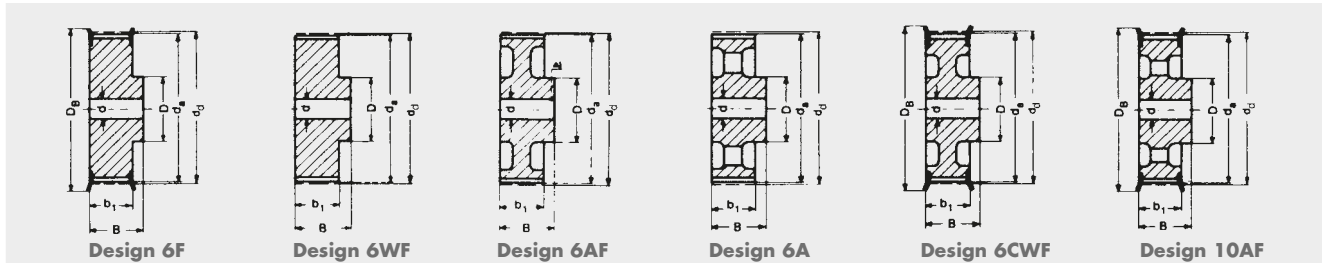

Profile L – tooth pitch 9.525 mm and width code 075 – belt width 19.1 mm

Belt designation	Number of teeth	Design	Material	d _w [mm]	d _a [mm]	D _B [mm]	b ₁ [mm]	B [mm]	D [mm]	Pilot bore d [mm]	Finished bore d _{max} [mm]	Weight approx. [kg]
10 L 075	10	6F	St	30.32	29.56	36	25	32	22	6	13	0.15
12 L 075	12	6F	St	36.38	35.62	42	25	32	28	8	17	0.23
13 L 075	13	6F	St	39.41	38.65	44	25	32	30	8	19	0.26
14 L 075	14	6F	St	42.45	41.68	48	25	32	33	8	20	0.32
15 L 075	15	6F	St	45.48	44.72	51	25	32	36	8	23	0.35
16 L 075	16	6F	St	48.51	47.75	54	25	32	38	8	23	0.42
17 L 075	17	6F	St	51.54	50.78	57	25	32	40	10	24	0.45
18 L 075	18	6F	St	54.57	53.81	60	25	32	40	10	24	0.51
19 L 075	19	6F	St	57.61	56.84	60	25	32	40	10	24	0.57
20 L 075	20	6F	St	60.64	59.88	66	25	32	46	10	28	0.63
21 L 075	21	6F	St	63.67	62.91	71	25	32	46	10	28	0.70
22 L 075	22	6F	St	66.70	65.94	75	25	32	50	10	30	0.75
24 L 075	24	6F	St	72.77	72.00	79	25	32	50	12	30	0.85
26 L 075	26	6F	St	78.83	78.07	87	25	32	50	12	30	1.00
28 L 075	28	6F	St	84.89	84.13	91	25	32	50	12	30	1.20
30 L 075	30	6F	St	90.96	90.20	97	25	32	50	12	30	1.40
32 L 075	32	6F	St	97.02	96.26	103	25	32	50	12	30	1.50
36 L 075	36	6WF	GG	109.15	108.38	115	25	32	55	12	32	1.30
40 L 075	40	6WF	GG	121.28	120.51	127	25	32	60	12	35	1.60
44 L 075	44	6AF	GG	133.40	132.64	140	25	32	60	12	35	1.70
48 L 075	48	6AF	GG	145.53	144.77	152	25	32	60	12	35	1.90
60 L 075	60	6A	GG	181.91	181.15	—	26	35	60	15	35	1.80
72 L 075	72	6A	GG	218.30	217.53	—	26	35	60	15	35	2.30
84 L 075	84	6A	GG	254.68	253.92	—	26	35	60	15	35	2.50

Profile L – tooth pitch 9.525 mm and width code 100 – belt width 25.4 mm

10 L 100	10	6F	St	30.32	29.56	36	31	38	22	6	13	0.81
12 L 100	12	6F	St	36.38	35.62	42	31	38	28	8	17	0.29
13 L 100	13	6F	St	39.41	38.65	44	31	38	30	8	19	0.30
14 L 100	14	6F	St	42.45	41.68	48	31	38	33	8	20	0.38
15 L 100	15	6F	St	45.48	44.72	51	31	38	36	8	23	0.40
16 L 100	16	6F	St	48.51	47.75	54	31	38	38	8	23	0.51
17 L 100	17	6F	St	51.54	50.78	57	31	38	40	10	24	0.54
18 L 100	18	6F	St	54.57	53.81	60	31	38	40	10	24	0.62
19 L 100	19	6F	St	57.61	56.84	60	31	38	40	10	24	0.69
20 L 100	20	6F	St	60.64	59.88	66	31	38	46	10	28	0.76
21 L 100	21	6F	St	63.67	62.91	71	31	38	46	10	28	0.82
22 L 100	22	6F	St	66.70	65.94	75	31	38	50	10	30	0.92
24 L 100	24	6F	St	72.77	72.00	79	31	38	50	12	30	1.10
26 L 100	26	6F	St	78.83	78.07	87	31	38	50	12	30	1.30
28 L 100	28	6F	St	84.89	84.13	91	31	38	50	12	30	1.40
30 L 100	30	6F	St	90.96	90.20	97	31	38	50	12	30	1.70
32 L 100	32	6F	St	97.02	96.26	103	31	38	50	12	30	1.80
36 L 100	36	6CWF	GG	109.15	108.38	115	32	32	55	12	32	1.50
40 L 100	40	6CWF	GG	121.28	120.51	127	32	32	60	12	35	1.80
44 L 100	44	10AF	GG	133.40	132.64	140	32	32	60	12	35	1.90
48 L 100	48	10AF	GG	145.53	144.77	152	32	32	60	12	35	2.10
60 L 100	60	6A	GG	181.91	181.15	—	32	35	60	15	35	2.00
72 L 100	72	6A	GG	218.30	217.53	—	32	35	60	15	35	2.50
84 L 100	84	6A	GG	254.68	253.92	—	32	35	60	15	35	2.70

St = Steel GG = Grey cast iron Subject to changes due to production.

TIMING BELT PULLEYS

optibelt ZRS PROFILE H FOR CYLINDRICAL BORES

STANDARD TIMING BELT PULLEYS

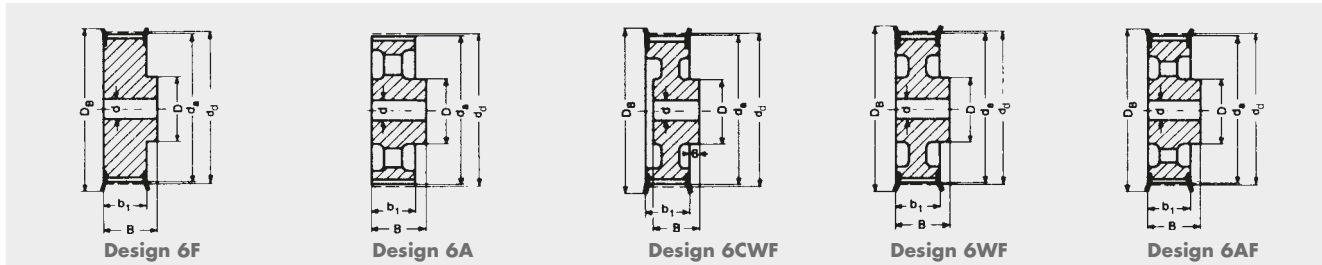

Profile H – tooth pitch 12.7 mm and width code 075 – belt width 19.1 mm

Belt designation	Number of teeth	Design	Material	d_w [mm]	d_a [mm]	D_B [mm]	b_1 [mm]	B [mm]	D [mm]	Pilot bore d [mm]	Finished bore d_{max} [mm]	Weight approx. [kg]
14 H 075	14	6F	St	56.59	55.22	64.0	26.4	40	40	10	24	0.50
16 H 075	16	6F	St	64.67	63.31	70.0	26.4	40	46	10	26	0.60
18 H 075	18	6F	St	72.77	71.39	79.0	26.4	40	54	12	32	0.80
19 H 075	19	6F	St	76.81	75.44	82.5	26.4	40	58	12	35	1.00
20 H 075	20	6F	St	80.85	79.48	86.0	26.4	40	62	12	35	1.10
21 H 075	21	6F	St	84.89	83.52	91.0	26.4	40	67	12	38	1.20
22 H 075	22	6F	St	88.93	87.56	94.0	26.4	40	70	12	38	1.40
24 H 075	24	6F	St	97.03	95.65	102.0	26.4	40	75	12	42	1.60
26 H 075	26	6F	St	105.11	103.73	112.0	26.4	40	80	15	45	1.80
28 H 075	28	6F	St	113.18	111.82	120.0	26.4	40	80	15	45	2.00
30 H 075	30	6F	St	121.29	119.90	128.0	26.4	40	80	15	45	2.10
32 H 075	32	6F	St	129.30	127.99	135.0	26.4	40	70	15	45	2.20
36 H 075	36	6F	St	145.54	144.16	152.0	26.4	40	80	15	45	2.40
40 H 075	40	6F	St	161.70	160.33	168.0	26.4	40	80	20	45	2.80
44 H 075	44	6A	GG	177.88	176.50	184.0	26.4	40	80	20	45	2.70
48 H 075	48	6A	GG	194.03	192.67	200.0	26.4	40	90	20	50	3.00

Profile H – tooth pitch 12.7 mm and width code 100 – belt width 25.4 mm

14 H 100	14	6F	St	56.60	55.22	63	31	41	40	10	24	0.65
16 H 100	16	6F	St	64.68	63.31	71	31	41	46	10	28	0.85
18 H 100	18	6F	St	72.77	71.39	79	31	41	54	12	32	1.10
19 H 100	19	6F	St	76.81	75.44	83	31	41	58	12	34	1.20
20 H 100	20	6F	St	80.85	79.48	87	31	41	62	12	35	1.40
21 H 100	21	6F	St	84.89	83.52	91	31	41	67	12	38	1.60
22 H 100	22	6F	St	88.94	87.56	93	31	41	70	12	41	1.70
24 H 100	24	6F	St	97.02	95.65	103	31	41	75	12	45	2.00
26 H 100	26	6CWF	GG	105.11	103.73	111	32	32	55	15	32	1.40
28 H 100	28	6CWF	GG	113.19	111.82	119	32	32	60	15	35	1.60
30 H 100	30	6CWF	GG	121.28	119.90	127	32	32	60	15	35	1.70
32 H 100	32	6WF	GG	129.36	127.99	135	32	40	70	20	40	2.20
36 H 100	36	6WF	GG	145.53	144.16	152	32	40	80	20	45	3.00
40 H 100	40	6AF	GG	161.70	160.33	168	32	40	80	20	45	2.80
44 H 100	44	6AF	GG	177.87	176.50	184	32	40	80	20	45	3.10
48 H 100	48	6AF	GG	194.04	192.67	200	32	40	80	20	45	3.30
60 H 100	60	6A	GG	242.55	241.18	—	34	45	80	20	45	5.50
72 H 100	72	6A	GG	291.06	289.69	—	34	45	80	20	45	7.10
84 H 100*	84	6A	GG	339.57	338.20	—	34	45	80	20	45	8.20
96 H 100*	96	6A	GG	388.08	386.71	—	34	45	80	20	45	9.90
120 H 100*	120	6A	GG	485.10	483.73	—	34	50	90	20	50	13.10

* Not available ex stock St = Steel GG = Grey cast iron Subject to changes due to production.

TIMING BELT PULLEYS

optibelt ZRS PROFILE H FOR CYLINDRICAL BORES

STANDARD TIMING BELT PULLEYS

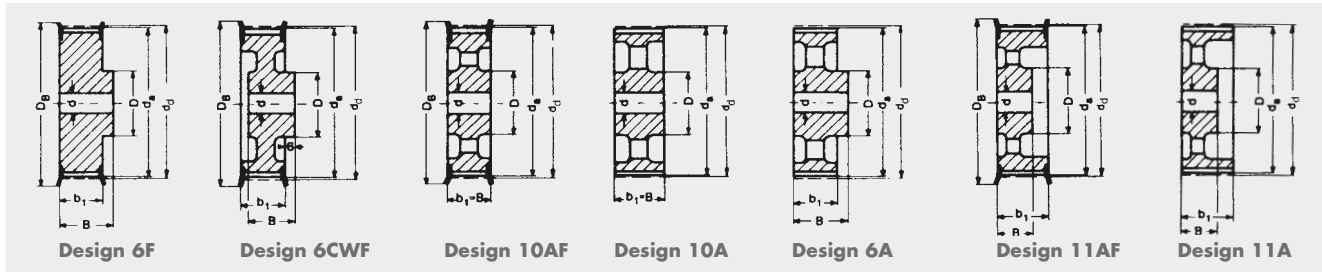

Profile H – tooth pitch 12.7 mm and width code 150 – belt width 38.1 mm

Belt designation	Number of teeth	Design	Material	d _w [mm]	d _a [mm]	D _B [mm]	b ₁ [mm]	B [mm]	D [mm]	Pilot bore d [mm]	Finished bore d _{max} [mm]	Weight approx. [kg]
14 H 150	14	6F	St	56.60	55.22	63	44	54	40	12	24	0.82
16 H 150	16	6F	St	64.68	63.31	71	44	54	46	12	28	1.10
18 H 150	18	6F	St	72.77	71.39	79	44	54	54	12	32	1.50
19 H 150	19	6F	St	76.81	75.44	83	44	54	58	12	34	1.70
20 H 150	20	6F	St	80.85	79.48	87	44	54	62	12	35	1.80
21 H 150	21	6F	St	84.89	83.52	91	44	54	67	12	38	2.20
22 H 150	22	6F	St	88.94	87.56	93	44	54	70	12	41	2.30
24 H 150	24	6F	St	97.02	95.65	103	44	54	75	12	45	2.60
26 H 150	26	6CWF	GG	105.11	103.73	111	45	35	55	15	32	1.70
28 H 150	28	6CWF	GG	113.19	111.82	119	45	35	60	15	35	1.90
30 H 150	30	6CWF	GG	121.28	119.90	127	45	35	60	15	35	2.10
32 H 150	32	6CWF	GG	129.36	127.99	135	45	45	70	20	40	2.60
36 H 150	36	6CWF	GG	145.53	144.16	152	45	45	80	20	45	3.20
40 H 150	40	10AF	GG	161.70	160.33	168	45	45	80	20	45	3.80
44 H 150	44	10AF	GG	177.87	176.50	184	45	45	80	20	45	3.70
48 H 150	48	10AF	GG	194.04	192.67	200	45	45	80	20	45	4.00
60 H 150	60	10A	GG	242.55	241.18	—	46	46	85	20	48	5.10
72 H 150	72	10A	GG	291.06	289.69	—	46	46	85	20	48	7.90
84 H 150*	84	10A	GG	339.57	338.20	—	46	46	85	20	48	8.90
96 H 150*	96	10A	GG	388.08	386.71	—	46	46	85	20	48	10.10
120 H 150*	120	6A	GG	485.10	483.73	—	46	55	95	24	55	17.20

Profile H – tooth pitch 12.7 mm and width code 200 – belt width 50.8 mm

14 H 200	14	6F	St	56.60	55.22	63	58	68	40	12	24	1.10
16 H 200	16	6F	St	64.68	63.31	71	58	68	46	15	28	1.40
18 H 200	18	6F	St	72.77	71.39	79	58	68	54	15	32	1.80
19 H 200	19	6F	St	76.81	75.44	83	58	68	58	15	34	2.10
20 H 200	20	6F	St	80.85	79.48	87	58	68	62	15	35	2.30
21 H 200	21	6F	St	84.89	83.52	91	58	68	67	15	38	2.60
22 H 200	22	6F	St	88.94	87.56	93	58	68	70	15	41	2.80
24 H 200	24	6F	St	97.02	95.65	103	58	68	75	15	45	3.40
26 H 200	26	6CWF	GG	105.11	103.73	111	58	42	60	15	35	2.30
28 H 200	28	6CWF	GG	113.19	111.82	119	58	42	60	15	35	2.50
30 H 200	30	6CWF	GG	121.28	119.90	127	58	42	70	15	40	2.90
32 H 200	32	6CWF	GG	129.36	127.99	135	58	47	70	20	40	3.20
36 H 200	36	6CWF	GG	145.53	144.16	152	58	47	80	20	45	3.80
40 H 200	40	11AF	GG	161.70	160.33	168	58	45	80	20	45	4.10
44 H 200	44	11AF	GG	177.87	176.50	184	58	45	80	20	45	4.40
48 H 200	48	11AF	GG	194.04	192.67	200	58	45	85	20	48	5.10
60 H 200	60	11A	GG	242.55	241.18	—	60	50	90	20	50	7.10
72 H 200	72	11A	GG	291.06	289.69	—	60	50	90	20	50	8.00
84 H 200*	84	11A	GG	339.57	338.20	—	60	50	90	20	50	12.00
96 H 200*	96	11A	GG	388.08	386.71	—	60	50	90	20	50	13.60
120 H 200*	120	10A	GG	485.10	483.73	—	60	60	100	24	57	16.60

* Not available ex stock St = Steel GG = Grey cast iron Subject to changes due to production.

TIMING BELT PULLEYS

optibelt **ZRS** PROFILE H, XH FOR CYLINDRICAL BORES

STANDARD TIMING BELT PULLEYS

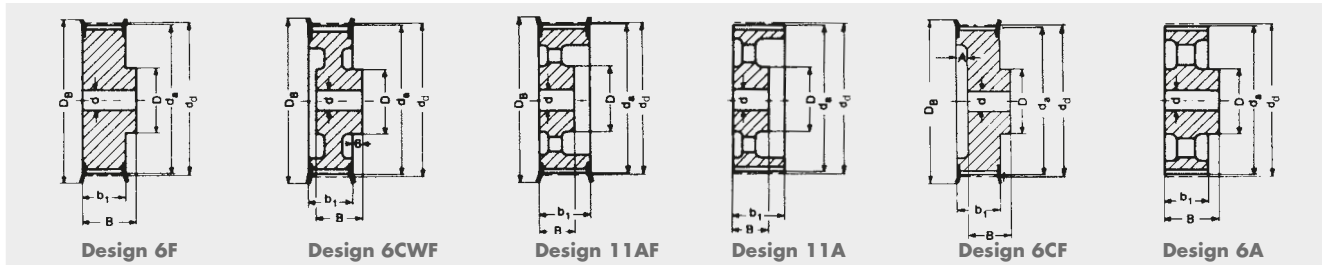

Profile H – tooth pitch 12.7 mm and width code 300 – belt width 76.2 mm

Belt designation	Number of teeth	Design	Material	d _w [mm]	d _g [mm]	D _B [mm]	b ₁ [mm]	B [mm]	D [mm]	A [mm]	Pilot bore d [mm]	Finished bore d _{max} [mm]	Weight approx. [kg]
16 H 300	16	6F	St	64.68	63.31	71	84	94	46	—	15	28	2.0
18 H 300	18	6F	St	72.77	71.39	79	84	94	54	—	15	32	2.6
19 H 300	19	6F	St	76.81	75.44	83	84	94	58	—	15	34	2.9
20 H 300	20	6F	St	80.85	79.48	87	84	94	62	—	15	35	3.2
21 H 300	21	6F	St	84.89	83.52	91	84	94	67	—	15	38	3.6
22 H 300	22	6F	St	88.94	87.56	93	84	94	70	—	15	41	4.0
24 H 300	24	6F	St	97.02	95.65	103	84	94	75	—	15	45	4.7
26 H 300	26	6CWF	GG	105.11	103.73	111	84	57	60	—	15	35	3.3
28 H 300	28	6CWF	GG	113.19	111.82	119	84	57	60	—	15	35	3.6
30 H 300	30	6CWF	GG	121.28	119.90	127	84	57	70	—	15	40	4.2
32 H 300	32	6CWF	GG	129.36	127.99	135	84	57	70	—	20	40	4.3
36 H 300	36	6CWF	GG	145.53	144.16	152	84	57	80	—	20	45	5.2
40 H 300	40	11AF	GG	161.70	160.33	168	84	55	80	—	20	45	5.6
44 H 300	44	11AF	GG	177.87	176.50	184	84	55	80	—	20	45	5.9
48 H 300	48	11AF	GG	194.04	192.67	200	84	55	85	—	20	48	6.6
60 H 300	60	11A	GG	242.55	241.18	—	86	55	100	—	20	57	9.9
72 H 300	72	11A	GG	291.06	289.69	—	86	55	100	—	20	57	13.0
84 H 300*	84	11A	GG	339.57	338.20	—	86	55	100	—	20	57	15.1
96 H 300*	96	11A	GG	388.08	386.71	—	86	55	100	—	20	57	18.2
120 H 300*	120	11A	GG	485.10	483.73	—	86	65	110	—	24	62	26.0

Profile XH – tooth pitch 22.225 mm and width code 200 – belt width 50.8 mm

18 XH 200*	18	6CF	GG	127.34	124.55	142	64.4	60	85	18	20	50	5.0
20 XH 200*	20	6CF	GG	141.49	138.69	155	64.4	60	95	18	20	55	6.0
22 XH 200*	22	6CF	GG	155.64	152.84	170	64.4	60	110	18	20	65	7.2
24 XH 200*	24	6CF	GG	169.79	166.69	184	64.4	60	125	18	25	70	8.6
26 XH 200*	26	6CF	GG	183.94	181.14	198	64.4	60	140	18	25	80	10.1
28 XH 200*	28	6CWF	GG	198.08	195.29	212	64.4	60	120	18	25	70	9.6
30 XH 200*	30	6CWF	GG	212.23	209.44	227	64.4	60	120	18	25	70	10.4
32 XH 200*	32	6CWF	GG	226.38	223.59	240	64.4	60	130	18	25	75	11.2
40 XH 200*	40	6CWF	GG	282.98	280.18	297	64.4	60	140	18	25	80	16.0
48 XH 200*	48	6A	GG	339.57	336.78	—	65.0	80	150	—	30	85	18.4
60 XH 200*	60	6A	GG	424.47	421.67	—	65.0	80	150	—	30	85	24.3
72 XH 200*	72	6A	GG	509.36	506.57	—	65.0	80	150	—	40	85	28.1
84 XH 200*	84	6A	GG	594.25	591.46	—	65.0	80	160	—	40	90	31.9
96 XH 200*	96	6A	GG	679.15	676.35	—	65.0	80	160	—	40	90	37.0

* Not available ex stock St = Steel GG = Grey cast iron Subject to changes due to production.

TIMING BELT PULLEYS

optibelt ZRS PROFILE XH FOR CYLINDRICAL BORES STANDARD TIMING BELT PULLEYS

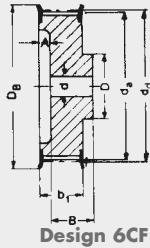

Design 6CF

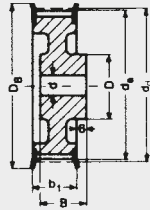

Design 6CWF

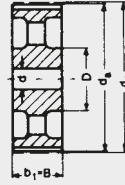

Design 10A

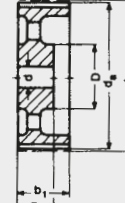

Design 11A

Profile XH – tooth pitch 22.225 mm and width code 300 – belt width 76.2 mm

Belt designation	Number of teeth	Design	Material	d_w [mm]	d_o [mm]	D_B [mm]	b_1 [mm]	B [mm]	D [mm]	A [mm]	Pilot bore d [mm]	Finished bore d_{max} [mm]	Weight approx. [kg]
18 XH 300*	18	6CF	GG	127.34	124.55	142	91.4	70	85	35	20	50	6.8
20 XH 300*	20	6CF	GG	141.49	138.69	155	91.4	70	95	35	20	55	7.4
22 XH 300*	22	6CF	GG	155.64	152.84	170	91.4	70	110	35	20	65	9.0
24 XH 300*	24	6CF	GG	169.79	166.69	184	91.4	70	125	35	25	70	10.6
26 XH 300*	26	6CF	GG	183.94	181.14	198	91.4	70	140	35	25	80	13.0
28 XH 300*	28	6CWF	GG	198.08	195.29	212	91.4	70	120	35	25	70	12.0
30 XH 300*	30	6CWF	GG	212.23	209.44	227	91.4	70	120	35	25	70	13.0
32 XH 300*	32	6CWF	GG	226.38	223.59	240	91.4	70	130	35	25	75	14.7
40 XH 300*	40	6CWF	GG	282.98	280.18	297	91.4	70	140	35	25	80	19.9
48 XH 300*	48	10A	GG	339.57	336.78	—	92.0	92	150	—	30	85	22.5
60 XH 300*	60	10A	GG	424.47	421.67	—	92.0	92	150	—	30	85	31.5
72 XH 300*	72	10A	GG	509.36	506.57	—	92.0	92	150	—	40	85	36.4
84 XH 300*	84	10A	GG	594.25	591.46	—	92.0	92	160	—	40	90	43.4
96 XH 300*	96	10A	GG	679.15	676.35	—	92.0	92	160	—	40	90	48.5

Profile XH – tooth pitch 22.225 mm and width code 400 – belt width 101.6 mm

18 XH 400*	18	6CF	GG	127.34	124.55	142	118.4	85	85	47	20	50	8.5
20 XH 400*	20	6CF	GG	141.49	138.69	155	118.4	85	95	47	20	55	9.4
22 XH 400*	22	6CF	GG	155.64	152.84	170	118.4	85	110	47	20	65	11.5
24 XH 400*	24	6CF	GG	169.79	166.69	184	118.4	85	125	47	25	70	13.4
26 XH 400*	26	6CF	GG	183.94	181.14	198	118.4	85	140	47	25	80	15.6
28 XH 400*	28	6CWF	GG	198.08	195.29	212	118.4	85	120	47	25	70	14.5
30 XH 400*	30	6CWF	GG	212.23	209.44	227	118.4	85	120	47	25	70	16.0
32 XH 400*	32	6CWF	GG	226.38	223.59	240	118.4	85	130	47	25	75	18.0
40 XH 400*	40	6CWF	GG	282.98	280.18	297	118.4	85	140	47	25	80	24.0
48 XH 400*	48	11A	GG	339.57	336.78	—	119.0	92	150	—	30	85	30.8
60 XH 400*	60	11A	GG	424.47	421.67	—	119.0	92	150	—	30	85	36.2
72 XH 400*	72	11A	GG	509.36	506.57	—	119.0	92	150	—	40	85	42.7
84 XH 400*	84	11A	GG	594.25	591.46	—	119.0	92	160	—	40	90	49.7
96 XH 400*	96	11A	GG	679.15	676.35	—	119.0	92	160	—	40	90	59.9

* Not available ex stock GG = Grey cast iron Subject to changes due to production.

TIMING BELT PULLEYS

optibelt **ZRS** PROFILE L FOR optibelt **TB** TAPER BUSHES

STANDARD TIMING BELT PULLEYS

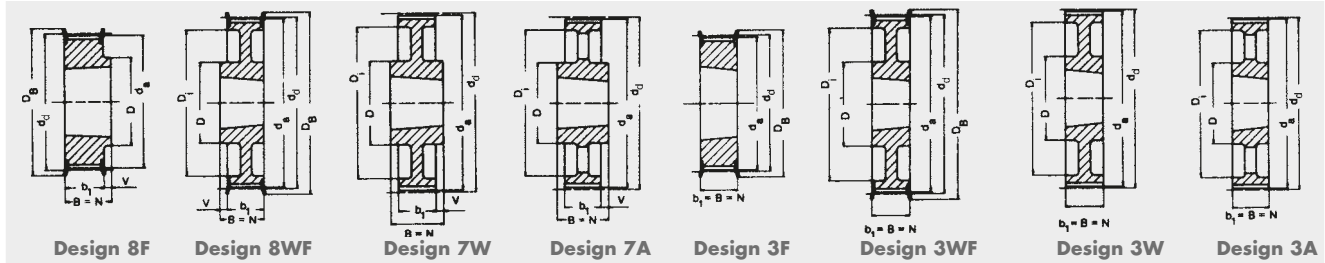

Profile L – tooth pitch 9.525 mm and width code 050 – belt width 12.7 mm

Belt designation	Number of teeth	Design	Material	d_w [mm]	d_o [mm]	D_B [mm]	b_1 [mm]	B [mm]	N [mm]	V [mm]	Z [mm]	D [mm]	D_i [mm]	Taper bush	Weight without bush approx. [kg]
TB 18 L 050	18	8F	St	54.57	53.81	60	19	22	22	3.0	—	44	—	1108	0.2
TB 19 L 050	19	8F	St	57.61	56.84	60	19	22	22	3.0	—	44	—	1108	0.2
TB 20 L 050	20	8F	St	60.64	59.88	66	19	22	22	3.0	—	48	—	1108	0.2
TB 21 L 050	21	8F	St	63.67	62.91	71	19	22	22	3.0	—	48	—	1108	0.3
TB 22 L 050	22	8F	St	66.70	65.94	75	19	22	22	3.0	—	51	—	1108	0.3
TB 23 L 050	23	8F	St	69.73	68.97	79	19	22	22	3.0	—	54	—	1108	0.4
TB 24 L 050	24	8F	St	72.77	72.00	79	19	22	22	3.0	—	54	—	1108	0.4
TB 25 L 050	25	8F	St	75.80	75.04	83	19	22	22	3.0	—	56	—	1108	0.5
TB 26 L 050	26	8F	St	78.83	78.07	87	19	22	22	3.0	—	60	—	1108	0.5
TB 27 L 050	27	8F	St	81.86	81.10	87	19	22	22	3.0	—	65	—	1108	0.6
TB 28 L 050	28	8F	St	84.89	84.13	91	19	22	22	3.0	—	65	—	1108	0.6
TB 30 L 050	30	8F	St	90.96	90.20	97	19	22	22	3.0	—	70	—	1108	0.8
TB 32 L 050	32	8F	St	97.02	96.26	103	19	22	22	3.0	—	74	—	1108	0.9
TB 36 L 050	36	8F	GG	109.15	108.39	115	19	22	22	3.0	—	87	—	1108	1.2
TB 40 L 050	40	8F	GG	121.28	120.51	127	19	25	25	6.0	—	97	—	1610	1.5
TB 48 L 050	48	8WF	GG	145.53	144.77	152	19	25	25	6.0	—	88	124	1610	2.3
TB 60 L 050	60	7W	GG	181.91	181.15	—	19	25	25	3.0	—	92	166	1610	2.0
TB 72 L 050	72	7A	GG	218.30	217.53	—	19	25	25	3.0	—	92	202	1610	3.0
TB 84 L 050	84	7A	GG	254.68	253.90	—	19	25	25	3.0	—	92	236	1610	4.0
TB 96 L 050	96	7A	GG	291.06	290.30	—	19	32	32	6.5	—	106	270	2012	5.5
TB 120 L 050	120	7A	GG	363.83	363.07	—	19	32	32	6.5	—	106	343	2012	6.8

Profile L – tooth pitch 9.525 mm and width code 075 – belt width 19.1 mm

TB 18 L 075	18	3F	St	54.57	53.81	60	25	25	25	—	—	—	—	1108	0.2
TB 19 L 075	19	3F	St	57.61	56.84	60	25	25	25	—	—	—	—	1108	0.3
TB 20 L 075	20	3F	St	60.64	59.88	66	25	25	25	—	—	—	—	1108	0.3
TB 21 L 075	21	3F	St	63.67	62.91	71	25	25	25	—	—	—	—	1108	0.4
TB 22 L 075	22	3F	St	66.70	65.94	75	25	25	25	—	—	—	—	1108	0.4
TB 23 L 075	23	3F	St	69.73	68.97	79	25	25	25	—	—	—	—	1108	0.4
TB 24 L 075	24	3F	St	72.77	72.00	79	25	25	25	—	—	—	—	1108	0.5
TB 25 L 075	25	3F	St	75.80	75.04	83	25	25	25	—	—	—	—	1108	0.6
TB 26 L 075	26	3F	St	78.83	78.07	87	25	25	25	—	—	—	—	1108	0.6
TB 27 L 075	27	3F	St	81.86	81.10	87	25	25	25	—	—	—	—	1108	0.7
TB 28 L 075	28	3F	St	84.89	84.13	91	25	25	25	—	—	—	—	1108	0.7
TB 30 L 075	30	3F	St	90.96	90.20	97	25	25	25	—	—	—	—	1108	0.9
TB 32 L 075	32	3F	St	97.02	96.26	103	25	25	25	—	—	—	—	1108	1.0
TB 36 L 075	36	3F	GG	109.15	108.39	115	25	25	25	—	—	—	—	1610	1.2
TB 40 L 075	40	3F	GG	121.28	120.51	127	25	25	25	—	—	—	—	1610	1.7
TB 48 L 075	48	3WF	GG	145.53	144.77	152	25	25	25	—	—	92	124	1610	2.5
TB 60 L 075	60	3W	GG	181.91	181.15	—	25	25	25	—	—	92	166	1610	3.0
TB 72 L 075	72	3A	GG	218.30	217.53	—	25	25	25	—	—	92	202	1610	4.0
TB 84 L 075	84	7A	GG	254.68	253.90	—	25	32	32	3.5	—	106	236	2012	5.2
TB 96 L 075	96	7A	GG	291.06	290.30	—	25	32	32	3.5	—	106	270	2012	6.5
TB 120 L 075	120	7A	GG	363.83	363.07	—	25	32	32	3.5	—	106	343	2012	7.6

Taper bush	1108	1610	2012
Bore d_2 [mm] from ... to ...	10-28	14-42	14-50

St = Steel
GG = Grey cast iron
Subject to changes due to production.
Bore diameter d_2 see page 91.

TIMING BELT PULLEYS

optibelt **ZRS** PROFILE L FOR optibelt **TB** TAPER BUSHES
STANDARD TIMING BELT PULLEYS

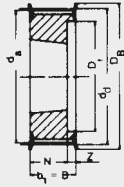

Design 5F

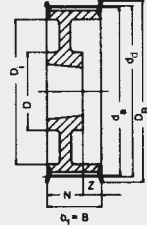

Design 5WF

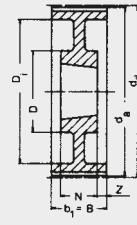

Design 9W

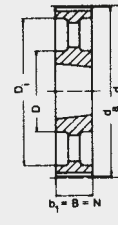

Design 3A

Profile L – tooth pitch 9.525 mm and width code 100 – belt width 25.4 mm

Belt designation	Number of teeth	Design	Material	d_w [mm]	d_o [mm]	D_B [mm]	b_1 [mm]	B [mm]	N [mm]	V [mm]	Z [mm]	D [mm]	D_i [mm]	Taper bush	Weight without bush approx. [kg]
TB 18 L 100	18	5F	St	54.57	53.81	60	31	31	22	—	9.0	—	38	1108	0.2
TB 19 L 100	19	5F	St	57.61	56.84	60	31	31	22	—	9.0	—	38	1108	0.3
TB 20 L 100	20	5F	St	60.64	59.88	66	31	31	22	—	9.0	—	45	1108	0.4
TB 21 L 100	21	5F	St	63.67	62.91	71	31	31	22	—	9.0	—	47	1108	0.4
TB 22 L 100	22	5F	St	66.70	65.94	75	31	31	22	—	9.0	—	51	1108	0.4
TB 23 L 100	23	5F	St	69.73	68.97	79	32	32	22	—	10.0	—	54	1108	0.5
TB 24 L 100	24	5F	St	72.77	72.00	79	32	32	22	—	10.0	—	54	1108	0.6
TB 25 L 100	25	5F	St	75.80	75.04	83	32	32	22	—	10.0	—	56	1108	0.6
TB 26 L 100	26	5F	St	78.83	78.07	87	32	32	22	—	10.0	—	60	1108	0.7
TB 27 L 100	27	5F	St	81.86	81.10	87	32	32	22	—	10.0	—	62	1108	0.8
TB 28 L 100	28	5F	St	84.89	84.13	91	32	32	22	—	10.0	—	65	1108	0.8
TB 30 L 100	30	5F	St	90.96	90.20	97	32	32	25	—	7.0	—	71	1210	0.9
TB 32 L 100	32	5F	St	97.02	96.26	103	32	32	25	—	7.0	—	75	1210	1.0
TB 36 L 100	36	5F	GG	109.15	108.39	115	32	32	25	—	7.0	—	89	1610	1.4
TB 40 L 100	40	5F	GG	121.28	120.51	127	32	32	25	—	7.0	—	101	1610	1.7
TB 48 L 100	48	5WF	GG	145.53	144.77	152	32	32	25	—	7.0	92	124	1610	2.7
TB 60 L 100	60	9W	GG	181.91	181.15	—	32	32	25	—	3.5	92	166	1610	2.4
TB 72 L 100	72	3A	GG	218.30	217.53	—	32	32	32	—	—	106	202	2012	4.4
TB 84 L 100	84	3A	GG	254.68	253.90	—	32	32	32	—	—	106	236	2012	6.0
TB 96 L 100	96	3A	GG	291.06	290.30	—	32	32	32	—	—	106	270	2012	7.1
TB 120 L 100	120	3A	GG	363.83	363.07	—	32	32	32	—	—	106	343	2012	8.5

Taper bush	1108	1210	1610	2012
Bore d_2 [mm] from ... to ...	10-28	11-32	14-42	14-50

St = Steel
GG = Grey cast iron
Subject to changes due to production.
Bore diameter d_2 see page 91.

TIMING BELT PULLEYS

optibelt **ZRS** PROFILE H FOR optibelt **TB** TAPER BUSHES

STANDARD TIMING BELT PULLEYS

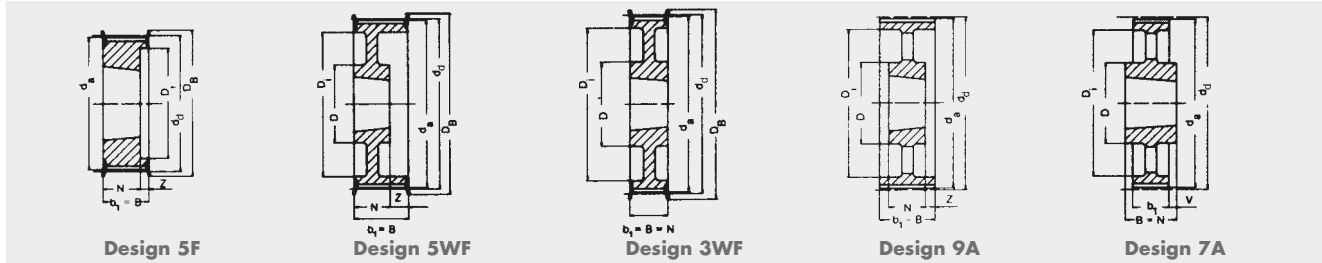

Profile H – tooth pitch 12.7 mm and width code 100 – belt width 25.4 mm

Belt designation	Number of teeth	Design	Material	d_w [mm]	d_o [mm]	D_B [mm]	b_1 [mm]	B [mm]	N [mm]	V [mm]	Z [mm]	D [mm]	D_i [mm]	Taper bush	Weight without bush approx. [kg]
TB 16 H 100	16	5F	St	64.68	63.31	71	31	31	22	—	9	—	45	1108	0.4
TB 18 H 100	18	5F	St	72.77	71.39	79	31	31	25	—	6	—	52	1210	0.5
TB 19 H 100	19	5F	St	76.81	75.44	83	31	31	25	—	6	—	56	1210	0.6
TB 20 H 100	20	5F	St	80.55	79.48	87	31	31	25	—	6	—	60	1210	0.7
TB 21 H 100	21	5F	GG	84.89	83.52	91	32	32	25	—	7	—	63	1210	0.8
TB 22 H 100	22	5F	GG	88.94	87.56	93	32	32	25	—	7	—	67	1210	0.9
TB 23 H 100	23	5F	GG	92.98	91.61	97	32	32	25	—	7	—	71	1610	0.9
TB 24 H 100	24	5F	GG	97.02	95.65	103	32	32	25	—	7	—	75	1610	1.0
TB 25 H 100	25	5F	GG	101.06	99.69	106	32	32	25	—	7	—	79	1610	1.0
TB 26 H 100	26	5F	GG	105.11	103.73	111	32	32	25	—	7	—	83	1610	1.2
TB 27 H 100	27	5F	GG	109.15	107.78	115	32	32	25	—	7	—	87	1610	1.3
TB 28 H 100	28	5F	GG	113.19	111.82	119	32	32	25	—	7	—	91	1610	1.5
TB 30 H 100	30	5F	GG	121.28	119.90	127	32	32	25	—	7	—	99	1610	1.7
TB 32 H 100	32	5WF	GG	129.36	127.99	135	32	32	25	—	7	92	108	1610	2.0
TB 36 H 100	36	5WF	GG	145.53	144.16	152	32	32	25	—	7	92	124	1610	2.7
TB 40 H 100	40	5WF	GG	161.70	160.33	168	32	32	25	—	7	92	140	1610	3.6
TB 44 H 100	44	3WF	GG	177.87	176.50	184	32	32	32	—	—	106	153	2012	3.8
TB 48 H 100	48	3WF	GG	194.04	192.67	200	32	32	32	—	—	106	169	2012	3.2
TB 60 H 100	60	9A	GG	242.55	241.18	—	34	34	32	—	1	106	223	2012	4.8
TB 72 H 100	72	9A	GG	291.06	289.69	—	34	34	32	—	1	106	270	2012	5.7
TB 84 H 100*	84	9A	GG	339.57	338.20	—	34	34	32	—	1	106	318	2012	6.8
TB 96 H 100*	96	7A	GG	388.08	386.71	—	34	45	45	5.5	—	119	366	2517	8.2
TB 120 H 100*	120	7A	GG	485.10	483.73	—	34	45	45	5.5	—	119	462	2517	12.1

Profile H – tooth pitch 12.7 mm and width code 150 – belt width 38.1 mm

TB 18 H 150	18	5F	St	72.77	71.39	79	45	45	25	—	20.0	—	53	1210	0.6
TB 19 H 150	19	5F	St	76.81	75.44	83	45	45	25	—	20.0	—	56	1210	0.7
TB 20 H 150	20	5F	St	80.55	79.48	87	45	45	25	—	20.0	—	60	1210	0.8
TB 21 H 150	21	5F	GG	84.89	83.52	91	45	45	25	—	20.0	—	64	1210	1.0
TB 22 H 150	22	5F	GG	88.94	87.56	93	45	45	25	—	20.0	—	68	1210	1.2
TB 23 H 150	23	5F	GG	92.98	91.61	97	45	45	25	—	20.0	—	71	1610	1.3
TB 24 H 150	24	5F	GG	97.02	95.65	103	45	45	25	—	20.0	—	74	1610	1.2
TB 25 H 150	25	5F	GG	101.06	99.69	106	45	45	25	—	20.0	—	78	1610	1.2
TB 26 H 150	26	5F	GG	105.11	103.73	111	45	45	25	—	20.0	—	82	1610	1.4
TB 27 H 150	27	5F	GG	109.15	107.78	115	45	45	25	—	20.0	—	87	1610	1.6
TB 28 H 150	28	5F	GG	113.19	111.82	119	45	45	25	—	20.0	—	91	1610	1.8
TB 30 H 150	30	5F	GG	121.28	119.90	127	45	45	25	—	20.0	—	99	1610	2.0
TB 32 H 150	32	5WF	GG	129.36	127.99	135	45	45	25	—	20.0	92	108	1610	2.3
TB 36 H 150	36	5WF	GG	145.53	144.16	152	45	45	25	—	20.0	92	124	1610	3.1
TB 40 H 150	40	5WF	GG	161.70	160.33	168	45	45	25	—	20.0	92	140	1610	4.0
TB 44 H 150	44	5WF	GG	177.87	176.50	184	45	45	32	—	13.0	106	153	2012	4.4
TB 48 H 150	48	5WF	GG	194.04	192.67	200	45	45	32	—	13.0	106	169	2012	4.8
TB 60 H 150	60	9A	GG	242.55	241.18	—	46	46	32	—	7.0	106	223	2012	5.4
TB 72 H 150	72	9A	GG	291.06	289.69	—	46	46	32	—	7.0	106	270	2012	6.5
TB 84 H 150*	84	9A	GG	339.57	338.20	—	46	46	32	—	7.0	106	320	2012	8.4
TB 96 H 150*	96	9A	GG	388.08	386.71	—	46	46	45	—	0.5	119	366	2517	11.0
TB 120 H 150*	120	9A	GG	485.10	483.73	—	46	46	45	—	0.5	119	462	2517	14.8

Taper bush	1108	1210	1610	2012	2517
Bore d_2 [mm] from ... to ...	10-28	11-32	14-42	14-50	16-60

St = Steel
GG = Grey cast iron
Subject to changes due to production.
Bore diameter d_2 see page 91.

* Not available ex stock

TIMING BELT PULLEYS

optibelt **ZRS** PROFILE H FOR optibelt **TB** TAPER BUSHES

STANDARD TIMING BELT PULLEYS

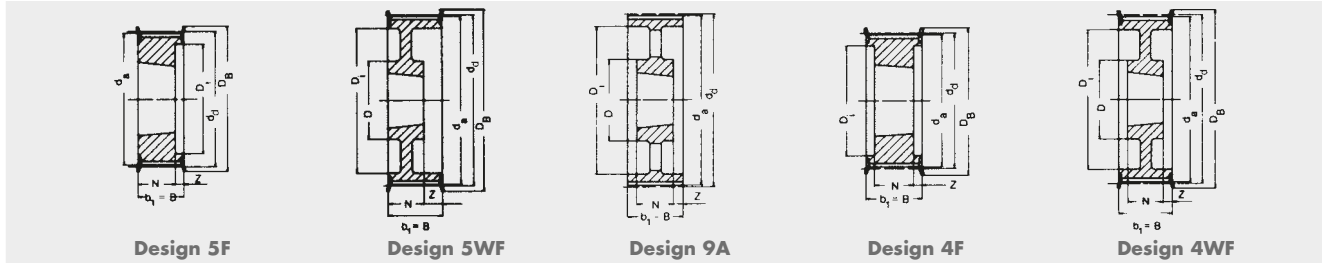

Profile H – tooth pitch 12.7 mm and width code 200 – belt width 50.8 mm

Belt designation	Number of teeth	Design	Material	d_w [mm]	d_o [mm]	D_B [mm]	b_1 [mm]	B [mm]	N [mm]	V [mm]	Z [mm]	D [mm]	D_i [mm]	Taper bush	Weight without bush approx. [kg]
TB 18 H 200	18	5F	St	72.77	71.39	79	58	58	25	—	33.0	—	52	1210	0.8
TB 19 H 200	19	5F	St	76.81	75.44	83	58	58	25	—	33.0	—	56	1610	0.9
TB 20 H 200	20	5F	St	80.55	79.48	87	58	58	25	—	33.0	—	60	1610	1.0
TB 21 H 200	21	5F	GG	84.89	83.52	91	58	58	25	—	33.0	—	64	1610	1.7
TB 22 H 200	22	5F	GG	88.94	87.56	93	58	58	25	—	33.0	—	68	1610	1.5
TB 23 H 200	23	5F	GG	92.98	91.61	97	58	58	25	—	33.0	—	71	1610	1.8
TB 24 H 200	24	5F	GG	97.02	95.65	103	58	58	25	—	33.0	—	74	1610	1.5
TB 25 H 200	25	5F	GG	101.06	99.69	106	58	58	25	—	33.0	—	78	1610	1.5
TB 26 H 200	26	5F	GG	105.11	103.73	111	58	58	25	—	33.0	—	82	1610	1.8
TB 27 H 200	27	5F	GG	109.15	107.78	115	58	58	25	—	33.0	—	87	1610	1.9
TB 28 H 200	28	5F	GG	113.19	111.82	119	58	58	25	—	33.0	—	91	1610	1.9
TB 30 H 200	30	5F	GG	121.28	119.90	127	58	58	25	—	33.0	—	99	1610	2.3
TB 32 H 200	32	5F	GG	129.36	127.99	135	58	58	32	—	26.0	—	107	2012	3.0
TB 36 H 200	36	5WF	GG	145.53	144.16	152	58	58	32	—	26.0	102	124	2012	3.0
TB 40 H 200	40	5WF	GG	161.70	160.33	168	58	58	32	—	26.0	106	140	2012	3.6
TB 44 H 200	44	5WF	GG	177.87	176.50	184	58	58	32	—	26.0	106	153	2012	4.5
TB 48 H 200	48	5WF	GG	194.04	192.67	200	58	58	45	—	13.0	119	169	2517	4.6
TB 60 H 200	60	9A	GG	242.55	241.18	—	60	60	45	—	7.5	119	223	2517	7.0
TB 72 H 200	72	9A	GG	291.06	289.69	—	60	60	45	—	7.5	119	270	2517	8.0
TB 84 H 200*	84	9A	GG	339.57	338.20	—	60	60	45	—	7.5	119	320	2517	9.0
TB 96 H 200*	96	9A	GG	388.08	386.71	—	60	60	45	—	7.5	119	366	2517	11.5
TB 120 H 200*	120	9A	GG	485.10	483.73	—	60	60	45	—	7.5	119	462	2517	15.4

Profile H – tooth pitch 12.7 mm and width code 300 – belt width 76.2 mm

TB 20 H 300	20	4F	St	80.55	79.48	87	84	84	38	—	23.0	—	65	1615	1.5
TB 21 H 300	21	4F	GG	84.89	83.52	91	84	84	38	—	23.0	—	66	1615	1.2
TB 22 H 300	22	4F	GG	88.94	87.56	93	84	84	38	—	23.0	—	67	1615	1.6
TB 23 H 300	23	4F	GG	92.98	91.61	97	84	84	38	—	23.0	—	71	1615	1.8
TB 24 H 300	24	4F	GG	97.02	95.65	103	84	84	38	—	23.0	—	75	1615	2.1
TB 25 H 300	25	4F	GG	101.06	99.69	106	84	84	38	—	23.0	—	79	1615	2.0
TB 26 H 300	26	4F	GG	105.11	103.73	111	84	84	38	—	23.0	—	83	1615	2.7
TB 27 H 300	27	4F	GG	109.15	107.78	115	84	84	32	—	26.0	—	87	2012	3.0
TB 28 H 300	28	4F	GG	113.19	111.82	119	84	84	32	—	26.0	—	91	2012	2.4
TB 30 H 300	30	4F	GG	121.28	119.90	127	84	84	32	—	26.0	—	99	2012	2.9
TB 32 H 300	32	4F	GG	129.36	127.99	135	84	84	45	—	19.5	—	107	2517	3.3
TB 36 H 300	36	4F	GG	145.53	144.16	152	84	84	45	—	19.5	—	124	2517	4.5
TB 40 H 300	40	4F	GG	161.70	160.33	168	84	84	45	—	19.5	—	137	2517	6.0
TB 44 H 300	44	4WF	GG	177.87	176.50	184	86	86	45	—	20.5	119	153	2517	6.6
TB 48 H 300	48	4WF	GG	194.04	192.67	200	86	86	45	—	20.5	119	169	2517	7.6
TB 60 H 300	60	9A	GG	242.55	241.18	—	86	86	45	—	20.5	119	223	2517	8.4
TB 72 H 300	72	9A	GG	291.06	289.69	—	86	86	45	—	20.5	119	270	2517	10.4
TB 84 H 300*	84	9A	GG	339.57	338.20	—	86	86	45	—	20.5	119	320	2517	12.5
TB 96 H 300*	96	9A	GG	388.08	386.71	—	86	86	76	—	5.0	150	362	3030	14.2
TB 120 H 300*	120	9A	GG	485.10	483.73	—	86	86	76	—	5.0	150	460	3030	18.8

Taper bush	1210	1610	1615	2012	2517	3030
Bore d_2 [mm] from ... to ...	11-32	14-42	14-42	14-50	16-60	35-75

St = Steel
GG = Grey cast iron
Subject to changes due to production.
Bore diameter d_2 see page 91.

* Not available ex stock

TIMING BELT PULLEYS

optibelt **ZRS** PROFILE XH FOR optibelt **TB** TAPER BUSHES
STANDARD TIMING BELT PULLEYS

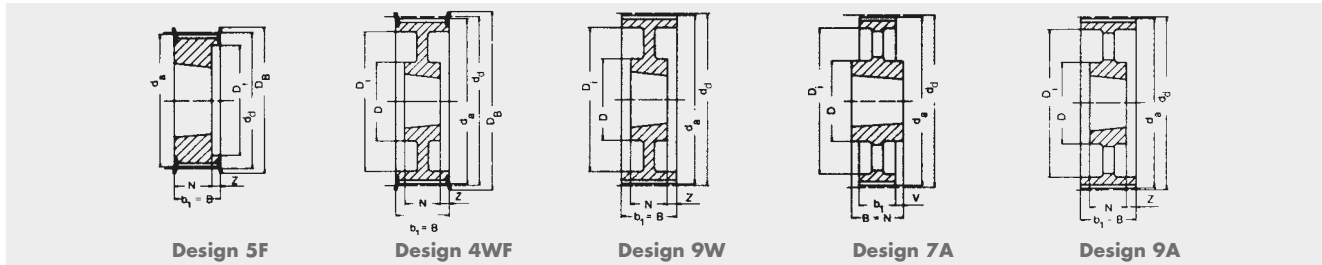

Profile XH – tooth pitch 22.225 mm and width code 200 – belt width 50.8 mm

Belt designation	Number of teeth	Design	Material	d_w [mm]	d_o [mm]	D_B [mm]	b_1 [mm]	B [mm]	N [mm]	V [mm]	Z [mm]	D [mm]	D_i [mm]	Taper bush	Weight without bush approx. [kg]
TB 18 XH 200*	18	5F	GG	127.34	124.55	138	64	64	45	—	20.0	—	95	2517	2.6
TB 20 XH 200*	20	5F	GG	141.49	138.69	154	64	64	45	—	20.0	—	110	2517	3.6
TB 22 XH 200*	22	5F	GG	155.64	152.84	168	64	64	45	—	20.0	—	120	2517	4.8
TB 24 XH 200*	24	5F	GG	169.79	166.69	183	64	64	45	—	20.0	—	135	2517	6.1
TB 26 XH 200*	26	5F	GG	183.94	181.14	198	64	64	45	—	20.0	—	150	2517	7.4
TB 28 XH 200*	28	4WF	GG	198.08	195.29	211	64	64	45	—	10.0	120	165	2517	9.0
TB 30 XH 200*	30	4WF	GG	212.23	209.44	226	64	64	45	—	10.0	120	180	2517	8.6
TB 32 XH 200*	32	4WF	GG	226.38	223.59	240	64	64	45	—	10.0	120	195	2517	9.8
TB 40 XH 200*	40	4WF	GG	282.98	280.18	296	64	64	51	—	7.0	160	245	3020	13.3
TB 48 XH 200*	48	9W	GG	339.57	336.78	—	64	64	51	—	6.5	160	300	3020	19.0

Profile XH – tooth pitch 22.225 mm and width code 300 – belt width 76.2 mm

TB 18 XH 300*	18	5F	GG	127.34	124.55	138	90	90	45	—	45.0	—	95	2517	3.7
TB 20 XH 300*	20	5F	GG	141.49	138.69	154	90	90	45	—	45.0	—	110	2517	4.7
TB 22 XH 300*	22	5F	GG	155.64	152.84	168	90	90	45	—	45.0	—	120	2517	6.0
TB 24 XH 300*	24	5F	GG	169.79	166.69	183	90	90	45	—	45.0	—	135	2517	7.6
TB 26 XH 300*	26	5F	GG	183.94	181.14	198	90	90	45	—	45.0	—	150	2517	9.8
TB 28 XH 300*	28	5F	GG	198.08	195.29	211	90	90	51	—	39.0	—	165	3020	11.6
TB 30 XH 300*	30	5F	GG	212.23	209.44	226	90	90	51	—	39.0	—	180	3020	11.9
TB 32 XH 300*	32	5F	GG	226.38	223.59	240	90	90	51	—	39.0	—	195	3020	13.8
TB 40 XH 300*	40	4WF	GG	282.98	280.18	296	90	90	51	—	19.5	160	245	3020	19.5
TB 48 XH 300*	48	9W	GG	339.57	336.78	—	90	90	51	—	19.5	160	300	3020	27.0

Taper bush	2012	2517	3020	3535
Bore d_2 [mm] from ... to ...	14-50	16-60	25-75	35-90

GG = Grey cast iron
Subject to changes
due to production.

Bore diameter d_2 see page 91.

TIMING BELT PULLEYS

optibelt ZRS PROFILE XH FOR optibelt TB TAPER BUSHES STANDARD TIMING BELT PULLEYS

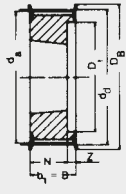

Design 5F

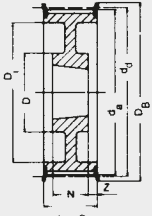

Design 4WF

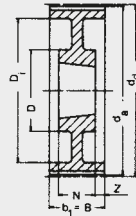

Design 9W

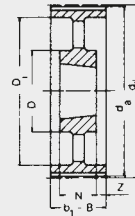

Design 9A

Profile XH – tooth pitch 22.225 mm and width code 400 – belt width 101.6 mm

Belt designation	Number of teeth	Design	Material	d_w [mm]	d_o [mm]	D_B [mm]	b_1 [mm]	B [mm]	N [mm]	V [mm]	Z [mm]	D [mm]	D_i [mm]	Taper bush	Weight without bush approx. [kg]
TB 20 XH 400*	20	5F	GG	141.49	138.69	154	119	119	45	—	74.0	—	110	2517	6.0
TB 22 XH 400*	22	5F	GG	155.64	152.84	168	119	119	45	—	74.0	—	120	2517	7.2
TB 24 XH 400*	24	5F	GG	169.79	166.69	183	119	119	51	—	68.0	—	135	3020	8.4
TB 26 XH 400*	26	5F	GG	183.94	181.14	198	119	119	51	—	68.0	—	150	3020	10.3
TB 28 XH 400*	28	5F	GG	198.08	195.29	211	119	119	51	—	68.0	—	165	3020	12.3
TB 30 XH 400*	30	5F	GG	212.23	209.44	226	119	119	51	—	68.0	—	180	3020	14.3
TB 32 XH 400*	32	5F	GG	226.38	223.59	240	119	119	51	—	68.0	—	195	3020	19.9
TB 40 XH 400*	40	4WF	GG	282.98	280.18	296	119	119	89	—	15.0	190	245	3535	24.6
TB 48 XH 400*	48	9W	GG	339.57	336.78	—	119	119	89	—	15.0	190	300	3535	30.0

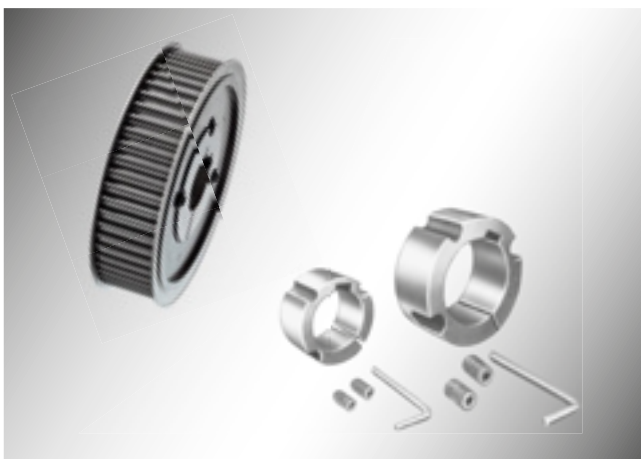

optibelt TB taper bushes

optibelt TB taper bushes provide simple assembly of the pulleys onto the shafts – both with and without fitted keys.

Taper bush	2517	3020	3535
Bore d_2 [mm] from... to ...	16-60	25-75	35-90

GG = Grey cast iron
Subject to changes
due to production.

Bore diameter d_2 see page 91.

* Not available ex stock

Flanged pulleys

The pulleys may be fitted with flanges on one or both sides to assist the smooth running of the timing belt. If the drive centre distance is $\geq 8 d_{wk}$ one pulley should be equipped with flanges on both sides. We recommend the use of standard pulleys. If this is not possible due to design reasons, special pulleys may be employed.

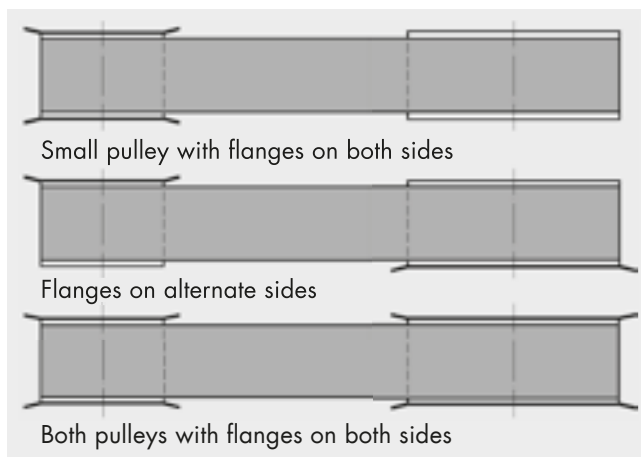

Maximum timing belt width

The maximum timing belt width should not exceed the pitch diameter of the smallest pulley in the drive.

Tension idlers

Idlers are grooved or flat faced pulleys that do not transmit power within the drive system. Because they create additional bending stresses within the belt, their use should be used according to the following guidelines:

- Diameter of the tension idler \geq according to the smallest recommended pulley diameter for the profile
- Width of the idler \geq widths of the timing belt pulleys in the drive
- Always install idlers in the slack side of the drive
- Inside idlers:
 - ≤ 40 teeth always use a timing belt pulley
 - > 40 teeth a flat belt pulley can be used
- In general, outside idlers should always be flat faced as they run on the top surface of the belt
- Crowned idlers should never be used
- Fit the tension idlers in such a way as to enable as many teeth as possible to mesh with the small pulley
- Keep the arc of contact on the tension idler as small as possible

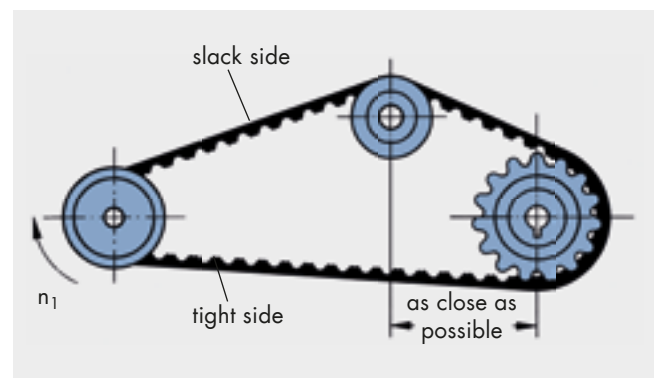
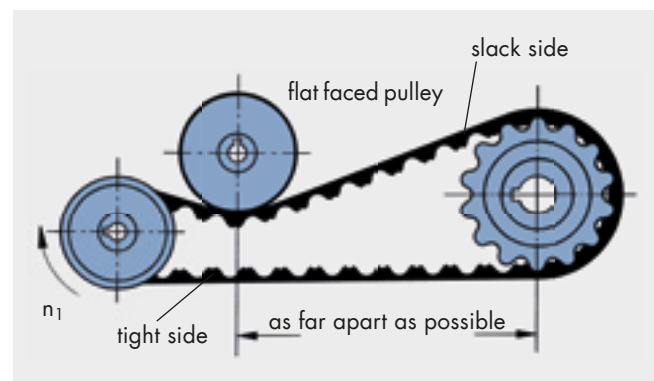

DESIGN SUPPORT

INSTALLATION AND MAINTENANCE



Safety hints

Drives which are correctly designed according to geometric and performance aspects using OPTIBELT timing belts ensure a high level of operational safety and optimum belt life. It has been proved in practice that unsatisfactory service life is frequently due to installation and maintenance errors. We recommend that the following precautions be taken:

- **Timing belt pulleys**

The teeth should be clean and comply with standard specifications.

- **Alignment**

All shafts and pulleys should be aligned before belt installation.

Maximum deviation in shaft parallel alignment:

Belt width n [mm]	Angle deviation
≤ 25	± 1°
> 25 ≤ 50	± 0.5°
> 50 ≤ 100	± 0.25°
> 100	± 0.15°

- **Timing belt sets**

Timing belts which run in pairs or in multiples on the one drive system must always be ordered as sets. This way it is guaranteed that all belts are cut from the same production sleeve and have an identical length.

- **Installation**

Before installation, the drive centre distance should be reduced to enable the timing belts to be fitted with absolutely no force. If this is not possible the timing belts must be fitted together with one or both of the pulleys. Any use of force during the fitting of the belt will result in damage to the high quality low-stretch tension cord and other components; this damage may not be immediately apparent.

In case taper bushes are used, the studs should be checked after 0.5 to 1 hour via torque wrench. Tightening torque values see page 91.

- **Tensioning**

Tensioning should be carried out in accordance with the guidelines on page 44. Once fitted, no further checking or adjustment is necessary.

- **Idlers**

Idlers should be avoided. If this is not possible, please follow our recommendations on page 112 of this manual.

- **Maintenance**

OPTIBELT timing belts require virtually no maintenance if they are used under normal environmental conditions.

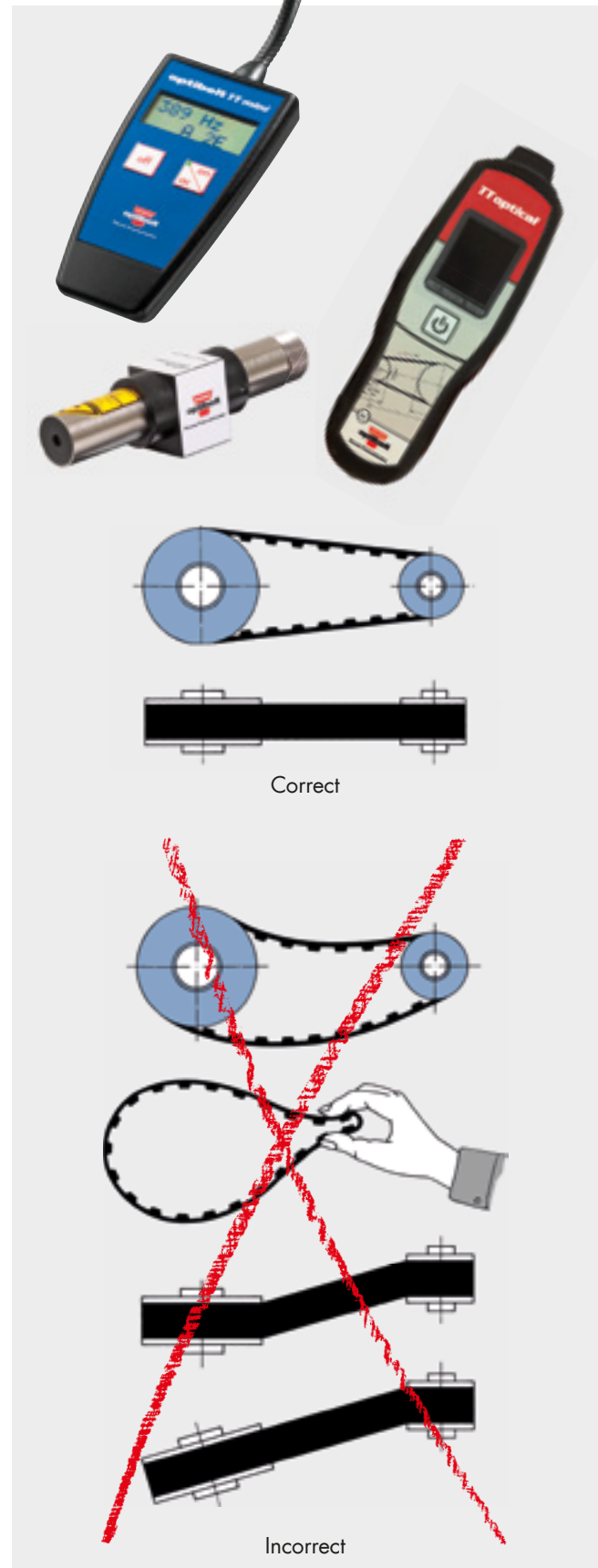

DESIGN HINTS

PROBLEMS – CAUSES – REMEDIES



Problems	Causes	Remedies
Severe wear on the belt tooth faces	Incorrect belt tension Tooth pitch selection error Overloading	Adjust belt tension Check profile selected, and replace if necessary Use wider belts with higher power transmission capability
Excessive wear at the tooth basis	Excessive belt tension Drive design too weak Incorrect pulleys	Reduce the tension Increase belt width or pulley diameters Replace pulleys
Unusual wear on the edges of the belt	Shafts not parallel Incorrect flanged pulleys Drive centre distance varying during running	Realign the shafts Replace flanges Strengthen mountings and chassis
Belt teeth shearing off	Too few teeth in mesh Overloading	Increase diameter of the small pulley or choose wider belts Redesign using wider belts or larger pulleys
Excessive lateral belt movement	Shafts not parallel Pulleys not in line Shock loading with belt tension too great	Realign the shafts Realign pulleys Reduce the belt tension
Flanges becoming detached	Pulleys not in line Very high lateral pressure of the timing belt Incorrect flange installation	Realign the pulleys Realign the shafts Install flanges correctly
Apparent belt stretch	Incorrect storage	Adjust belt tension, reinforce and secure bearing support
Excessive operating noise	Incorrect shaft alignment Belt tension too high Pulley diameter too small Belt overloaded Belt width too great at higher speeds	Realign shafts Reduce the tension Increase pulley diameter Increase belt width or number of teeth in mesh Reduce the belt width by redesign using larger belt profile
Unusual wear on the pulleys	Unsuitable material Incorrect tooth pitch Insufficient surface hardness	Use stronger materials Replace pulleys Use harder material or carry out surface hardening
Top surface of the belt brittle and cracking	Ambient temperature above +100 °C Unacceptable radiation	Replace belt with extra heat-resistant design Screen or use suitable belt design
Cracks in the belt surface	Ambient temperature below -30 °C	Replace belt with extra cold-resistant design
Softening of belt surface	Effects of contamination	Screen or use suitable belt design

DESIGN SUPPORT

optibelt ZR TIMING BELTS, DOUBLE-SIDED ACCORDING TO ISO 5296



Structure

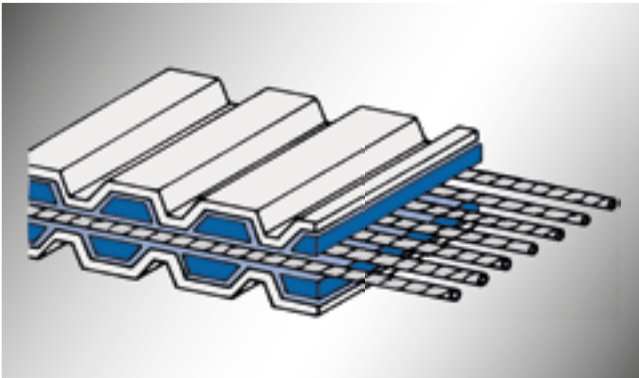

Tension cord

As standard belts, the tension cord consists of continuous, spirally wound glass fibre. This material ensures high tensile strength with the minimum stretch. Exceptional flexibility is achieved by embedding the cord in the centre.

Teeth

The teeth are arranged directly opposite each other and are manufactured from a medium hard, shear- and wear-resistant rubber compound. They mesh exactly with the tooth groove of the pulley with minimum resistance. As long as six teeth or more are in mesh, the capacity of the belt is used optimally.

Fabric cover

Both sides of the teeth are covered with a tough, friction resistant fabric. This fabric with its low coefficient of friction is therefore characterised by a long operational life.

Drive design

The protective covering on both tooth faces and the resultant identical power transmission capability of both sides of the belt, allow for an unlimited distribution of the power to be transmitted. The maximum allowed nominal power rating can be transmitted from either the inner or the outer tooth face. With several driven pulleys the power can be distributed in any combination through both sides of the belt. The total power transmitted cannot, however, exceed the maximum permitted levels.

Example:

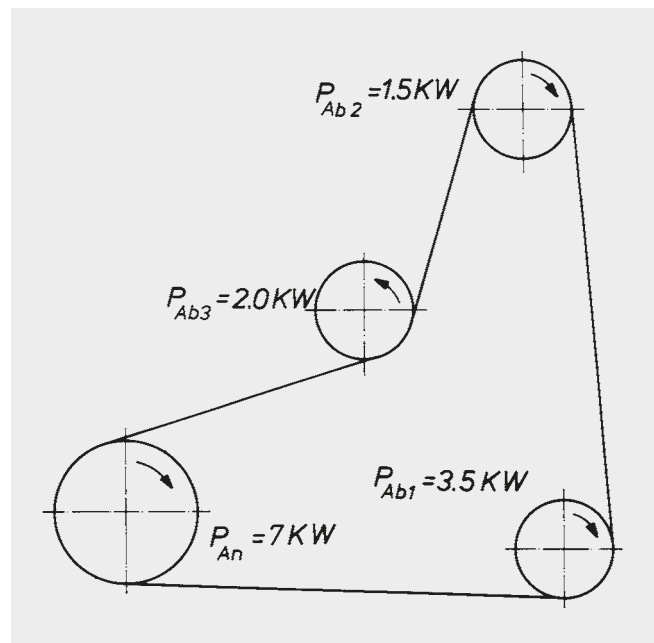

The design must be based on the nominal power values for standard belts (see pages 60 to 71). All available sizes on pages 32 to 34.

DESIGN SUPPORT

ATTACHMENTS

OVERVIEW OF STANDARDS



Federal Republic of Germany

- DIN 109 Sheet 1 – Drive Elements; Circumferential Speeds
- DIN 109 Sheet 2 – Drive Elements; Centre Distances for V-Belt Drives
- DIN 111 – Pulleys for Flat Transmission Belts; Dimensions, Nominal Torque
- DIN 111 Sheet 2 – Pulleys for Flat Transmission Belts; Classification for Electrical Machines
- DIN 2211 Sheet 1 – Grooved Pulleys for Narrow V-Belts; Dimensions, Materials
- DIN 2211 Sheet 2 – Grooved Pulleys for Narrow V-Belts; Inspections of Grooves
- DIN 2211 Sheet 3 – Grooved Pulleys for Narrow V-Belts; Classification for Electrical Machines
- DIN 2215 – Endless V-Belts, Classical Profiles; Minimum Datum Diameter of the Pulleys, Internal and Datum Belt Length
- DIN 2216 – Open-Ended V-Belts; Dimensions
- DIN 2217 Sheet 1 – V-Belt Pulleys for Classical Profiles; Dimensions, Materials
- DIN 2217 Sheet 2 – V-Belt Pulleys for Classical Profiles; Inspections of Grooves
- DIN 2218 – Endless V-Belts, Classical Profiles for Mechanical Engineering; Calculation of Drives, Performance Data
- DIN 7716 – Rubber Products; Requirements for Storage, Cleaning and Maintenance
- DIN 7719 Part 1 – Endless Wide V-Belts for Industrial Speed Changers; Belts and Groove Profiles for Corresponding Pulleys
- DIN 7719 Part 2 – Endless Wide V-Belts for Industrial Speed Changers; Measurement of Centre Distance Variations
- DIN 7721 Part 1 – Synchronous Belt Drives, Metric Pitch; Synchronous Belts
- DIN 7721 Part 2 – Synchronous Belt Drives, Metric Pitch; Tooth Space Profile of Synchronous Pulleys
- DIN 7722 – Endless Hexagonal Belts for Agricultural Machines and Groove Profiles of Corresponding Pulleys
- DIN 7753 Part 1 – Endless Narrow V-Belts for Mechanical Engineering; Dimensions
- DIN 7753 Part 2 – Endless Narrow V-Belts for Mechanical Engineering; Drive Calculation, Performance Data
- DIN 7753 Part 3 – Endless Narrow V-Belts for the Automotive Industry; Dimensions
- DIN 7753 Part 4 – Endless Narrow V-Belts for the Automotive Industry; Fatigue Testing
- DIN 7867 – V-Ribbed Belts and Pulleys
- DIN/ISO 5290 – Grooved Pulleys for Joined Narrow V-Belts; Groove Profiles: 9J; 15J; 20J; 25J
- DIN/ISO 5294 – Synchronous Belt Drives; Pulleys
- DIN/ISO 5296 – Synchronous Belt Drives; Belts
- DIN 22100-7 – Articles from Synthetics for Use in Underground Mines, Paragraph 5.4 – V-Belts
- DIN EN 60695-11-10 – Fire Hazard Testing

ISO – International Organization for Standardization

- ISO 22 – Widths of Flat Transmission Belts and Corresponding Pulleys
- ISO 63 – Flat Belt Drives; Lengths
- ISO 99 – Diameter of the Belt Pulleys for Flat Belts
- ISO 100 – Bulging Height of the Belt Pulleys for Flat Belts
- ISO 155 – Belt Pulleys; Limiting Values for Adjustment of Centre Distances
- ISO 254 – Quality, Finish and Balance of Belt Pulleys
- ISO 255 – Pulleys for Classical V-Belts and Narrow V-Belts; Geometric Testing of Grooves
- ISO 1081 – Vocabulary from V-Belts, V-Ribbed Belts and Pulleys
- ISO 1604 – Endless Speed Changer Belts and Pulleys for Mechanical Engineering
- ISO 1813 – Electrical Conductibility of V-Belts, Kraftbands, V-Ribbed Belts, Wide V-Belts, Double Profile V-Belts
- ISO 2230 – Please Consult DIN 7716
- ISO 2790 – Narrow V-Belt Drives for the Automotive Industry; Dimensions
- ISO 3410 – Endless Speed Changer Belts and Pulleys for Agricultural Machinery

- ISO 4183 – Grooved Pulleys for Classical V-Belts and Narrow V-Belts
- ISO 4184 – Classical V-Belts and Narrow V-Belts; Lengths
- ISO 5256 – Synchronous Belt Drives; Belt Tooth Pitch Code Part 1 MXL; XL; L; H; XH; XXH Part 2 MXL; XXL Metric Dimension
- ISO 5287 – Narrow V-Belts for the Automotive Industry; Fatigue Testing
- ISO 5288 – Vocabulary from Timing Belt Drives
- ISO 5289 – Endless Double Profile V-Belts and Pulleys for Agricultural Machinery
- ISO 5290 – Grooved Pulleys for Joined Narrow V-Belts; Profiles: 9J; 15J; 20J; 25J
- ISO 5291 – Grooved Pulleys for Joined Classical V-Belts; Profiles: AJ; BJ; CJ; DJ
- ISO 5292 – Industrial V-Belt Drives; Calculations of the Performance Data and Centre Distance
- ISO 5294 – Synchronous Belt Drives; Pulleys – “Inch Pitch”
- ISO 5295 – Timing Belts; Calculations of the Performance Data and Centre Distance – “Inch Pitch”
- ISO 5296 – Synchronous Belt Drives; Belts – “Inch Pitch”
- ISO 8370-1 – Dynamic Test to Determine Pitch Zone Location with V-Belts
- ISO 8370-2 – Dynamic Test to Determine Pitch Zone Location with V-Ribbed Belts
- ISO/DIS 8419 – Belt Drives, Joined Narrow V-Belts; Lengths in Effective System; 9N/J, 15N/J, 25N/J
- ISO 9010 – Synchronous Belt Drives – Automotive Belts
- ISO 9011 – Synchronous Belt Drives – Automotive Pulleys
- ISO 9563 – Antistatic Endless Synchronous Belts; Electrical Conductibility; Characteristics and Testing Method
- ISO 9980 – Belt Drives; V-Belt Pulleys; Geometric Inspection of Grooves
- ISO 9981 – Belt Drives – Pulleys and V-Ribbed Belts for the Automotive Industry; PK Profile
- ISO 9982 – Belt Drives; Pulleys and V-Ribbed Belts for Industrial Requirements; Geometric Data PH, PJ, PK, PL and PM
- ISO 11749 – Belt Drives – V-Ribbed Belts for the Automotive Industry, Fatigue Testing
- ISO 12046 – Synchronous Belt Drives, Automotive Belts; Physical Characteristics
- ISO/CD 13050 – Synchronous Belt Drives, Curvilinear Timing Belts
- ISO/CD 17396 – Synchronous Belt Drives; Metric Pitch, Profiles T and AT

USA

- RMA/MPTA IP-20 – Classical V-Belts and Sheaves (A; B; C; D; Cross Profiles)
- RMA/MPTA IP-21 – Double (Hexagonal) Belts (AA; BB; CC; DD Cross Profiles)
- RMA/MPTA IP-22 – Narrow Multiple V-Belts (3V; 5V; and 8V Cross Profiles)
- RMA/MPTA IP-23 – Single V-Belts (2L; 3L; 4L; and 5L Cross Profiles)
- RMA/MPTA IP-24 – Synchronous Belts (MXL; XL; L; H; XH; and XXH Belt Profiles)
- RMA/MPTA IP-25 – Variable Speed V-Belts (12 Cross Profiles)
- RMA/MPTA IP-26 – V-Ribbed Belts (PH; PJ; PK; PL; and PM Cross Profiles)
- RMA/MPTA IP-27 – Curvilinear Toothed Synchronous Belts (8M – 14M Pitches)
- ASAE S 211.... – V-Belt Drives for Agricultural Machines
- SAE J636b – V-Belts and Pulleys
- SAE J637 – Automotive V-Belt Drives

DESIGN HINTS

DATA SHEET FOR THE CALCULATION/CHECKING OF TIMING BELT DRIVES



Company: _____
 Street address/P.O. Box number: _____
 Town or city/Post code: _____
 Contact person: _____
 Department: _____ Date: _____
 Phone: _____ Fax: _____
 E-mail: _____

For test New drive
 For pilot production Existing drive
 For series production Requirement _____ Pieces/Year

Currently fitted with:

pitch length	profile	width	manufacturer

Prime mover

Type (e.g. electric motor, diesel engine 3 cylinders) _____
 Size of the starting torque (e.g. MA = 1.8 MN) _____
 Type of start (e.g. star delta) _____
 Daily operating time _____ hours
 Number of starts _____ per hour per day
 Change in the direction of rotation _____ per minute per hour
 Power: P normal _____ kW
 P maximum _____ kW
 or max. torque _____ Nm at n_1 _____ min^{-1}
 Speed n_1 _____ min^{-1}
 Shaft layout: horizontal vertical
 inclined α _____ °
 Maximum allowed shaft loading $S_{a \max}$ _____ N
 Pitch diameter or number of teeth on the pulley:
 d_{w1} _____ mm z_1 _____ mm
 $d_{w1 \min}$ _____ mm $z_{1 \min}$ _____ mm
 $d_{w1 \max}$ _____ mm $z_{1 \max}$ _____ mm
 Maximum pulley face width _____ mm

Driven machine

Type (e.g. lathe, compressor) _____
 Start: under load no load
 Type of load: steady pulsating
 shock
 Required power transmission: P normal _____ kW
 P maximum _____ kW
 or max. torque _____ Nm at n_2 _____ min^{-1}
 Driven speed n_2 _____ min^{-1}
 $n_{2 \min}$ _____ min^{-1}
 $n_{2 \max}$ _____ min^{-1}
 Maximum allowed shaft loading $S_{a \max}$ _____ N
 Pitch diameter or number of teeth on the pulley:
 d_{w2} _____ mm z_2 _____ mm
 $d_{w2 \min}$ _____ mm $z_{2 \min}$ _____ mm
 $d_{w2 \max}$ _____ mm $z_{2 \max}$ _____ mm
 Maximum pulley face width _____ mm

Drive ratio i _____
 Centre distance a _____ mm
 Tensioning/idler pulley: inside idler
 outside idler
 d_w _____ mm pulley
 d_a _____ mm flat pulley

i_{\min} _____ i_{\max} _____
 a_{\min} _____ mm a_{\max} _____ mm
 in tight side
 in slack side
 moveable (e.g. spring loaded) _____
 fixed

Operating conditions: Ambient temperature

Influence of oil
 water
 acid
 dust

_____ °C minimum
 _____ °C maximum
 (e.g. oil mist, drops) _____
 (e.g. spray water) _____
 (type, concentration, temperature) _____
 (type) _____

Special drives: e.g. for drives with tensioning/idler pulleys, three or multi-pulley drives or for drives with contra rotating pulleys drawings are necessary. Please use the other side of this page for this drawing.



Details about the drive:

OPTIBELT GmbH

Corveyer Allee 15
37671 Hörter
GERMANY

T +49 (0) 5271-621

F +49 (0) 5271-976200

E info@optibelt.com



www.optibelt.com