

THE BLUE ONES FROM ROSTA

Components for increased output

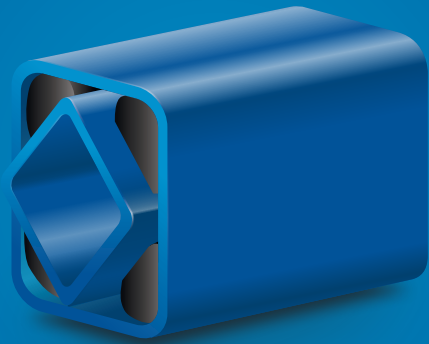



Simple and clever

DEAR READER

A unique success story for 75 years

Thanks to an innovative product idea, ROSTA is the world's leading manufacturer of rubber spring and damping systems. Since 1944, our consistent customer-centric approach has had top priority and contributes significantly to the sustained success of the company – enabling us to celebrate the 75th anniversary of our success story in 2019.

In addition to our headquarters and production site in Switzerland, ROSTA has 6 subsidiaries in Germany, Italy, Canada, the USA, China and Australia with over 120 employees. Our global network with over 30 partners in more than 40 countries positioning us to serve our customers far beyond our borders swiftly and promptly.

Many customers from all industries already benefit from our comprehensive know-how, becoming more profitable and competitive thanks to ROSTA products.

Our components are maintenance-free, noiseless, have a long service life and are used for a wide range of applications. Many years of experience in research and development in our own laboratory and the collaborative work with our partners and customers form an important knowledge base from which we can continue to offer innovative solutions.

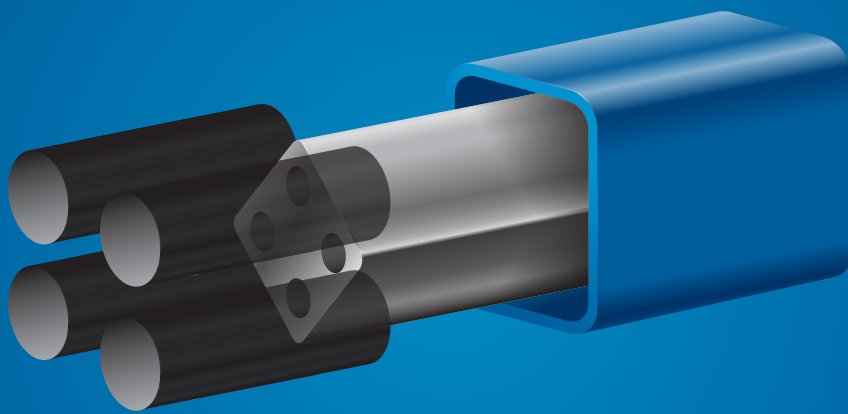

Perfect combination

TABLE OF CONTENTS

ROSTA GROUP

Page 1.1 – 1.9

1

RUBBER SUSPENSION ELEMENTS

Page 2.1 – 2.17

2

OSCILLATING MOUNTINGS

Page 3.1 – 3.21

3

VIBRATION DAMPERS

Page 4.1 – 4.9

4

TENSIONER DEVICES

Page 5.1 – 5.17

5

MOTORBASES

Page 6.1 – 6.7

6

TECHNOLOGY

Page 7.1 – 7.52

7



ROSTA GROUP

ROSTA – yesterday, today, tomorrow

It began in the mid-1940s with the construction of rubber-mounted trailer axles. This laid the foundation for the ROSTA success story.

Over the years, ROSTA has developed components that have found countless uses in mechanical and plant engineering.

Even today, new applications for the ROSTA rubber suspension element are constantly being realised.

New technologies and an innovative culture at ROSTA will enable the future development of new components with new materials.

OVERVIEW OF ROSTA

History

It began with the search for a simple and inexpensive solution for a trailer: to absorb, dampen and support the axle.

Production

In the end, the ROSTA rubber suspension element is only as good as the rubber inside. Many new possibilities are developing for the improvement of the quality and production of rubber inserts for specific and/or customized applications. This is possible through collaboration with our «own» rubber manufacturer.

Functions

Let yourself be inspired by the wide range of application possibilities for our rubber suspension elements! Tensioning, dampening and supporting are characteristics that require a solution in almost every technical design.

Employees

At ROSTA, we have the best employees. Mutual respect and a friendly atmosphere make our company one big family.

Industries

It started with the axle suspension for a single industry. Today, ROSTA elements are used for countless applications in many different industrial branches. Every day we find new solutions that make our customers more competitive and profitable.

Distribution

Over 30 sales partners advise and support our customers worldwide. Our aim is to work with the best distributors around the world. We train them professionally so they can support their customers in the respective country without delay.

- 1944: Foundation
- 1968: First machine components
- 1978: Own laboratory
- 1992: ISO certification
- 2007: Acquisition Compounds AG
- 2019: Automated manufacturing



75 years of customer-oriented innovation

- Own rubber manufacturer
- The ability to adapt to changing customer and market needs
- Consistently high quality
- Lean Management / 5S
- Core competence in developing complex customer solutions



1.5 million elements sold each year

- Tensioning
- Dampening
- Supporting
- and many more



3 key functions in 1 element

- 35 % women in management positions
- 20 different nations
- Average 10 years of service
- Support of development and internal change



120 competent and motivated employees

- Industry
- Mining
- Food
- Agriculture



4 core markets

- Head office in Switzerland
- 6 subsidiaries
- Over 30 distribution partners in 40 countries



5 continents, over 40 countries

TECHNICAL COMPETENCE

Focus for continuous success

In our efforts to make use of our products in countless processing plants and machinery worldwide in an efficient and safe manner, we provide the world market with our know-how, our experience and with our high quality products.

In addition to standard components, we develop custom-made solutions in cooperation with our customers. With our elements, our customers are able to generate added value by designing their products with fewer components. We furthermore assist our customers and partners with the layout of systems using stress simulations.

Trainings

We are happy to pass on our expertise and many years of experience.



Service

Ensuring the optimum use of ROSTA solutions.



In-house laboratory

High and constant quality is the base of our success.

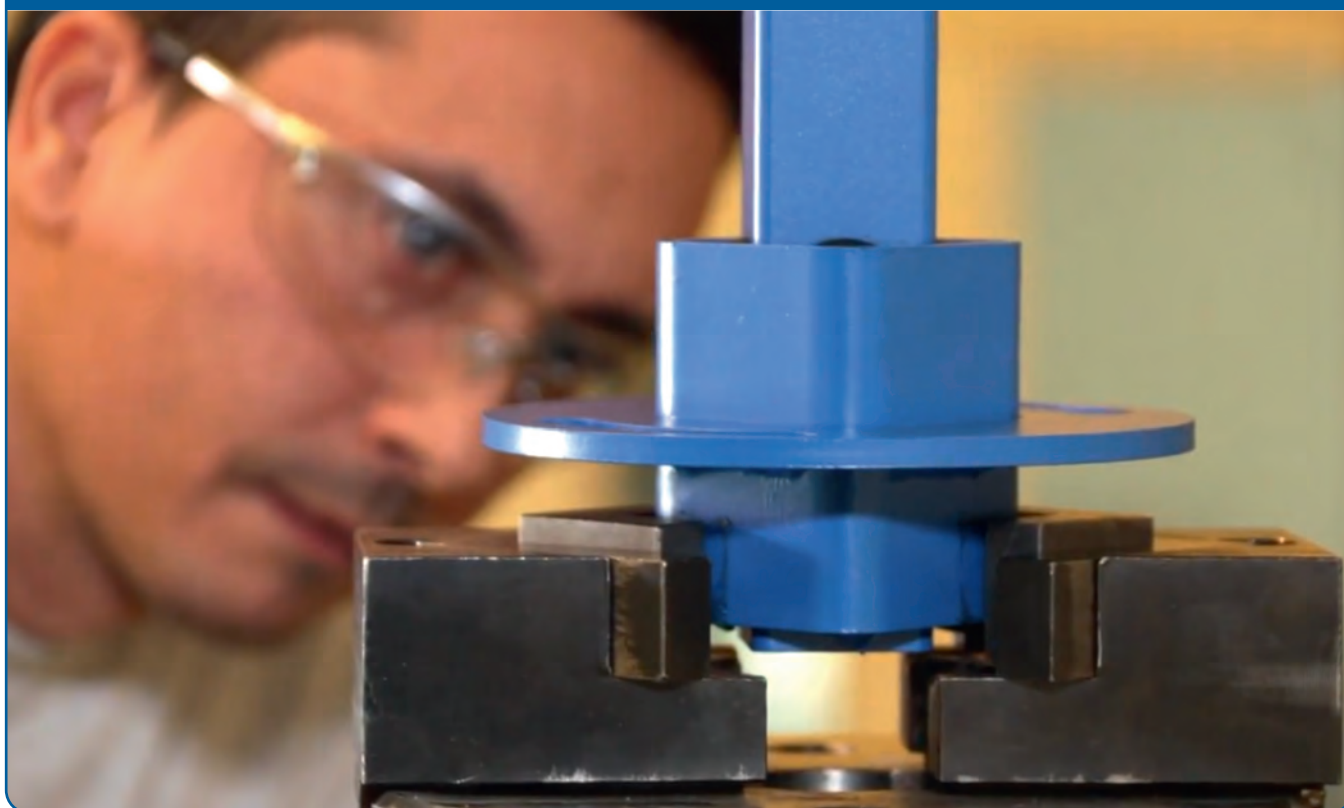

THE CORE OF OUR PRODUCT

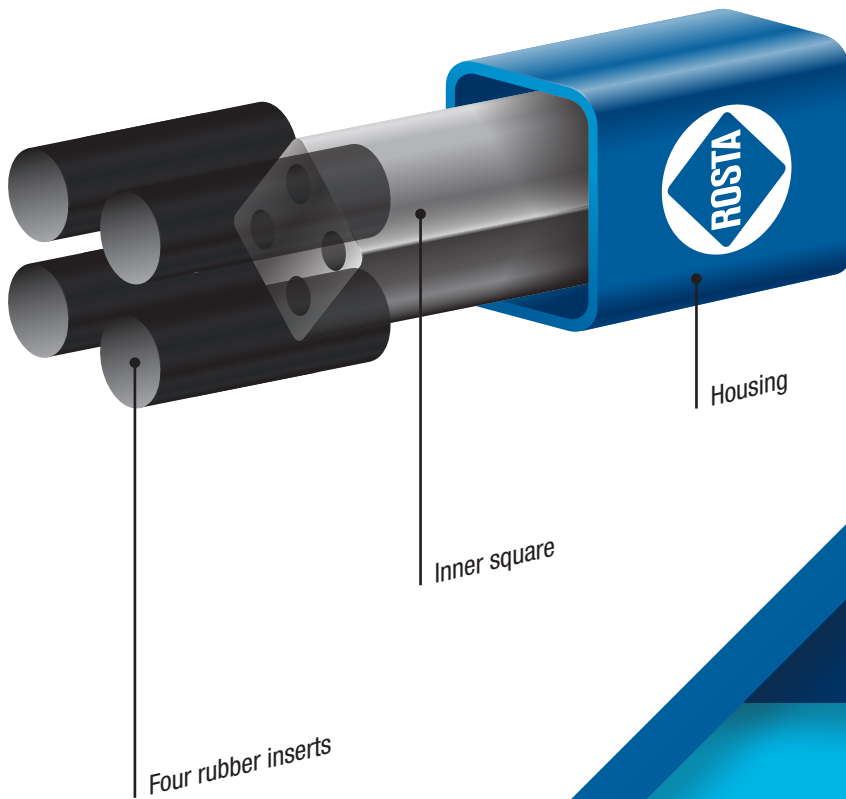
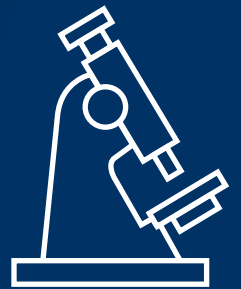
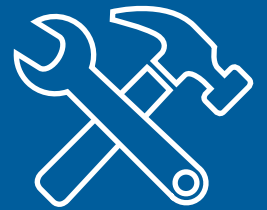

1

DEVELOPMENT

Our development team works closely with our application engineers and customers. We always focus on the customer's needs. New components and services ensure that ROSTA has a competitive advantage.

2

WORKMANSHIP

Production machines, handling equipment, tooling machines and processing systems equipped with state-of-the-art technology can only function perfectly if reliable and motivated employees stand fully behind even the smallest structural components. It is their competence, quality considerations and their great willingness to work that lay the foundations for the production of high quality goods.

3

QUALITY CONTROL

For our customers ISO standards are a guarantee of constant quality and performance. ROSTA is an ISO 9001 and ISO 14001 certified company.
The material tests that take place before and during production are the guarantee for a comprehensive and high quality standard.

4

VARIABILITY

Whether in terms of size, requirement and/or application, our elements from ROSTA are very flexible and customisable, which is why they are used in numerous applications.

1

OUR PORTFOLIO

Rubber suspension elements

Multifunctional elements

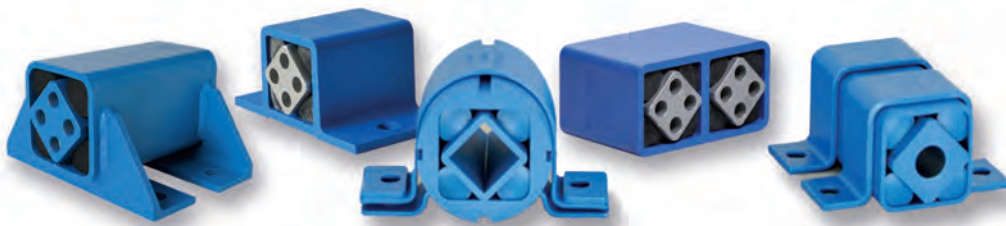

Oscillating mountings

Elastic suspensions for screening and conveying



Vibration dampers

Components for shock and vibration absorbing





long life cycle

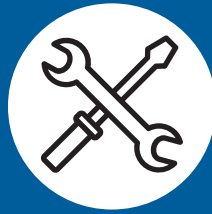

maintenance-free

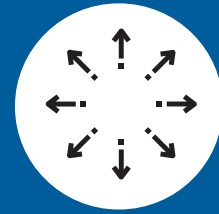

versatile

Tensioner devices

Tensioner systems for belt and chain drives



Motorbases

Self-tensioning motor mounts for all friction belt drives

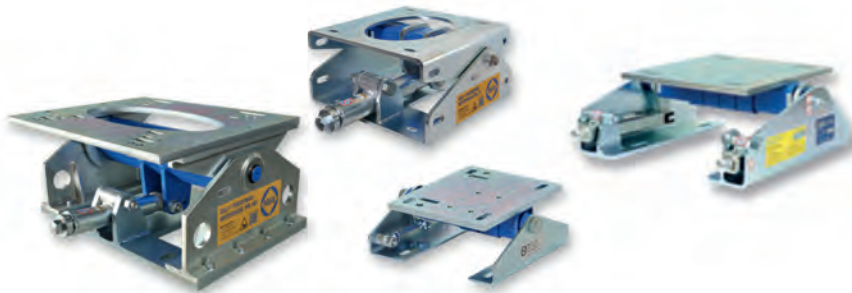

ROSTA HIVE

Condition / Process Monitoring & Predictive Maintenance



See separate
ROSTA HIVE brochure



RUBBER SUSPENSION ELEMENTS

Torsion-elastic spring assemblies for contemporary engineering and design

- Pendulum suspensions for unbalanced motors
- Torque supports for gear motors
- Torsional springs for continuous surface pressure
- Fully customized rubber suspensions available in exclusive design upon request
- Torsion elastic mounts offering constant pressure on workparts (infeed devices)
- Energy absorbing impact suspensions

Product advantages:



long service life

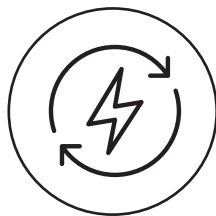



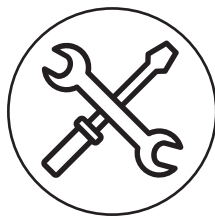





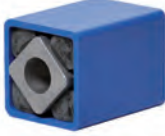

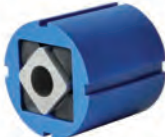
energy-saving

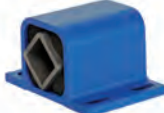

easy to install

Selection table rubber suspension elements (Rubmix 10)

		Type inner square			
		A Aluminium profile (from size 60 in steel)	C Aluminium profile	S Steel tube for plug-in connection	
		Illustration			Page
Type housing	DR Steel tube	DR-A 	DR-C 	DR-S 	2.4–2.6
	DK Aluminium profile	DK-A 	DK-C 	DK-S 	2.8–2.9
	DW Aluminium profile (from size 60 steel welded construction)	DW-A 15 to 50 	DW-C 15 to 50 	DW-S 15 to 50 	2.11–2.14
		DW-A 60 to 100 			
	DO Aluminium profile	DO-A 	DO-C 	DO-S 	2.15

- DK-C, DO-C and DO-S only on request.
- Note about accessories (BR, BK, WS) on pages 2.7, 2.10, 2.16.
- Aluminium profiles: extruded profiles, seawater resistant (DIN 1725).
- Blue paint: thickness 40–80 µm.
- Inner steel tube type S: electrodeposited galvanic zinc coating.
- Mounting bolts: strength class of 8.8.
- Welding heat will affect or destroy the rubber inserts – ask for customized elements.
- Stainless steel, zinc-plated versions or special paintings upon request.

List of torque and loads

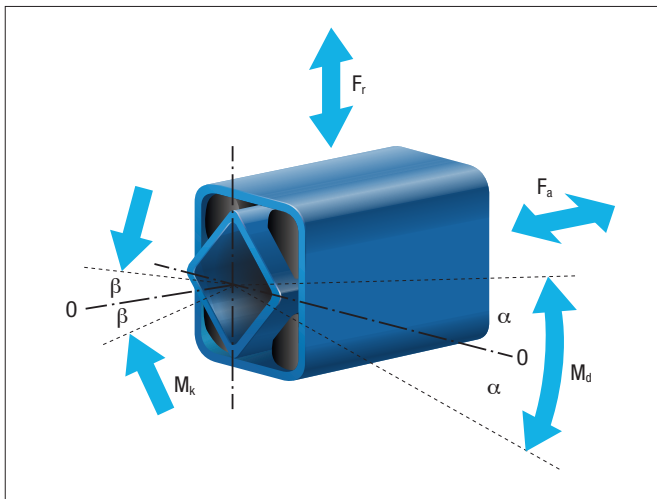

The values stated in the below mentioned list have been measured statically and are valid for the standard rubber quality «Rubmix 10». Intermediate values can be interpolated.

By applications with combined dynamic forces and high angles of oscillation please see chapter 7 «Technology» or contact ROSTA.

Element			Torque						Cardanic	Radial		Axial	
Nominal size	x	Length	M _d [Nm] angle ±α°						M _k [Nm] angle ±β°	Deflection ± s _r [mm]	Load F _r [N]	Deflection ± s _a [mm]	Load F _a [N]
			5°	10°	15°	20°	25°	30°	1°				
11	x	20	0.4	1.0	1.6	2.4	3.5	4.8	0.4	0.25	200	0.25	60
11	x	30	0.5	1.4	2.4	3.7	5.2	7.2	1.1	0.25	340	0.25	80
11	x	50	0.8	2.4	4.1	6.1	8.6	12.0	5.6	0.25	600	0.25	150
15	x	25	0.7	1.6	2.6	4.0	5.7	8.2	0.6	0.25	200	0.25	70
15	x	40	1.1	2.5	4.2	6.4	9.2	13.2	2.0	0.25	300	0.25	100
15	x	60	1.6	3.8	6.3	9.6	13.8	19.8	5.5	0.25	500	0.25	160
18	x	30	1.9	4.5	7.5	11.0	15.0	20.6	1.6	0.25	400	0.25	80
18	x	50	3.2	7.5	12.5	18.3	25.0	34.4	7.0	0.25	700	0.25	160
18	x	80	5.1	12.0	20.0	29.3	40.0	55.0	28.0	0.25	1000	0.25	300
27	x	40	4.7	10.7	17.5	26.9	39.5	57.0	3.8	0.5	800	0.5	200
27	x	60	7.0	16.0	26.3	40.3	59.3	85.5	11.5	0.5	1300	0.5	300
27	x	100	11.7	26.7	43.8	67.2	98.8	142.5	48.0	0.5	2400	0.5	600
38	x	60	13.0	30.4	50.6	78.0	113.0	162.0	11.4	0.5	1500	0.5	300
38	x	80	17.3	40.5	67.5	104.0	151.0	216.0	24.7	0.5	2000	0.5	500
38	x	120	26.0	60.8	101.2	156.0	226.0	324.0	76.0	0.5	3000	0.5	600
45	x	80	27.6	62.4	104.0	160.0	222.0	320.0	28.0	0.5	1900	0.5	560
45	x	100	34.5	78.0	130.0	200.0	278.0	400.0	54.0	0.5	3000	0.5	700
45	x	150	51.8	117.0	195.0	300.0	420.0	600.0	140.0	0.5	4800	0.5	1000
50	x	120	51	133	250	395	570	780	80	0.5	2800	0.5	800
50	x	160	77	197	363	570	820	1115	145	0.5	4500	0.5	950
50	x	200	102	260	475	745	1070	1450	250	0.5	6300	0.5	1100
50	x	300	150	385	700	1100	1590	2160	1200	0.5	8600	0.5	2200
60	x	150	75	170	300	460	700	1010	90	1.0	5400	1.0	1600
60	x	200	95	220	385	610	930	1380	250	1.0	7200	1.0	2200
60	x	300	140	365	630	995	1550	2240	900	1.0	9400	1.0	3200
70	x	200	140	380	650	1040	1490	2120	280	1.0	9000	1.0	2200
70	x	300	190	525	910	1470	2160	3150	1200	1.0	12000	1.0	3600
70	x	400	250	765	1315	2160	3175	4750	2200	1.0	14000	1.0	4000
80	x	200	200	500	850	1300	1900	2700	680	1.0	10000	1.0	2500
80	x	300	300	800	1300	2000	2900	4100	1500	1.0	15000	1.0	3800
80	x	400	400	1060	1800	2800	3900	5600	4600	1.0	19000	1.0	4700
100	x	250	400	1080	1800	2800	4100	6300	1200	1.0	15000	1.0	3200
100	x	400	640	1700	2900	4500	6600	10000	4300	1.0	28000	1.0	5800
100	x	500	800	2160	3600	5600	8200	12000	8000	1.0	38000	1.0	7500

Rubber Suspension Element

DR-A

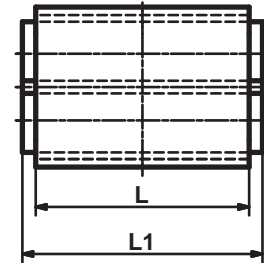
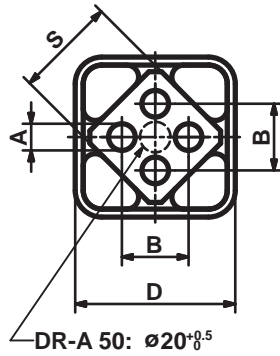

Part no.	Type	$\varnothing A$	B	$\square D$	$\square S$	L	L1	Weight [kg]
01 011 001	DR-A 15 × 25	$5^{+0.5}_0$	$10_{\pm 0.2}$	$27^{+0.4}_0$	15	25	$30^{0}_{-0.3}$	0.06
01 011 002	DR-A 15 × 40	$5^{+0.5}_0$	$10_{\pm 0.2}$	$27^{+0.4}_0$	15	40	$45^{0}_{-0.3}$	0.10
01 011 003	DR-A 15 × 60	$5^{+0.5}_0$	$10_{\pm 0.2}$	$27^{+0.4}_0$	15	60	$65^{0}_{-0.3}$	0.15
01 011 004	DR-A 18 × 30	$6^{+0.5}_0$	$12_{\pm 0.3}$	$32^{+0.3}_{-0.1}$	18	30	$35^{0}_{-0.3}$	0.10
01 011 005	DR-A 18 × 50	$6^{+0.5}_0$	$12_{\pm 0.3}$	$32^{+0.3}_{-0.1}$	18	50	$55^{0}_{-0.3}$	0.16
01 011 006	DR-A 18 × 80	$6^{+0.5}_0$	$12_{\pm 0.3}$	$32^{+0.3}_{-0.1}$	18	80	$85^{0}_{-0.3}$	0.26
01 011 007	DR-A 27 × 40	$8^{+0.5}_0$	$20_{\pm 0.4}$	$45^{+0.4}_0$	27	40	$45^{0}_{-0.3}$	0.24
01 011 008	DR-A 27 × 60	$8^{+0.5}_0$	$20_{\pm 0.4}$	$45^{+0.4}_0$	27	60	$65^{0}_{-0.3}$	0.36
01 011 009	DR-A 27 × 100	$8^{+0.5}_0$	$20_{\pm 0.4}$	$45^{+0.4}_0$	27	100	$105^{0}_{-0.3}$	0.60
01 011 010	DR-A 38 × 60	$10^{+0.5}_0$	$25_{\pm 0.4}$	$60^{+0.3}_{-0.2}$	38	60	$70^{0}_{-0.3}$	0.57
01 011 011	DR-A 38 × 80	$10^{+0.5}_0$	$25_{\pm 0.4}$	$60^{+0.3}_{-0.2}$	38	80	$90^{0}_{-0.3}$	0.75
01 011 012	DR-A 38 × 120	$10^{+0.5}_0$	$25_{\pm 0.4}$	$60^{+0.3}_{-0.2}$	38	120	$130^{0}_{-0.3}$	1.11
01 011 023	DR-A 45 × 80	$12^{+0.5}_0$	$35_{\pm 0.5}$	$75^{+0.3}_{-0.2}$	45	80	$90^{0}_{-0.3}$	1.26
01 011 024	DR-A 45 × 100	$12^{+0.5}_0$	$35_{\pm 0.5}$	$75^{+0.3}_{-0.2}$	45	100	$110^{0}_{-0.3}$	1.56
01 011 025	DR-A 45 × 150	$12^{+0.5}_0$	$35_{\pm 0.5}$	$75^{+0.3}_{-0.2}$	45	150	$160^{0}_{-0.3}$	2.32
01 011 026	DR-A 50 × 120	M12 × 40	$40_{\pm 0.5}$	$80^{+0.3}_{-0.2}$	50	120	$130^{0}_{-0.3}$	2.06
01 011 027	DR-A 50 × 200	M12 × 40	$40_{\pm 0.5}$	$80^{+0.3}_{-0.2}$	50	200	$210^{0}_{-0.3}$	3.42
01 011 028	DR-A 50 × 300	M12 × 40	$40_{\pm 0.5}$	$80^{+0.3}_{-0.2}$	50	300	$310^{0}_{-0.3}$	5.11

List of torque and loads on page 2.3.

If no other units are specified, the numbers given are in mm.

Rubber Suspension Element

DR-C

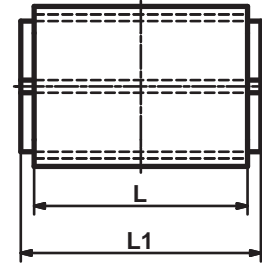
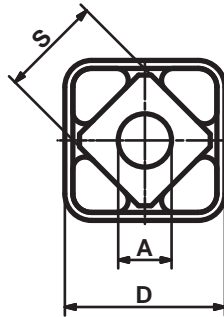
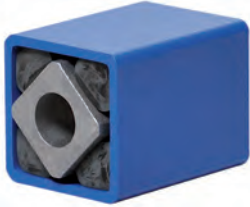

2

Part no.	Type	$\varnothing A$	B	$\square D$	$\square S$	L	L1	Weight [kg]
01 031 010	DR-C 15 x 25	10 ^{+0.4} _{-0.2}	10 ±0.2	27 ^{+0.4} ₀	15	25	30 ⁰ _{-0.3}	0.06
01 031 011	DR-C 15 x 40	10 ^{+0.4} _{-0.2}	10 ±0.2	27 ^{+0.4} ₀	15	40	45 ⁰ _{-0.3}	0.10
01 031 012	DR-C 15 x 60	10 ^{+0.4} _{-0.2}	10 ±0.2	27 ^{+0.4} ₀	15	60	65 ⁰ _{-0.3}	0.15
01 031 001	DR-C 18 x 30	13 ⁰ _{-0.2}	12 ±0.3	32 ^{+0.3} _{-0.1}	18	30	35 ⁰ _{-0.3}	0.11
01 031 002	DR-C 18 x 50	13 ⁰ _{-0.2}	12 ±0.3	32 ^{+0.3} _{-0.1}	18	50	55 ⁰ _{-0.3}	0.16
01 031 003	DR-C 18 x 80	13 ⁰ _{-0.2}	12 ±0.3	32 ^{+0.3} _{-0.1}	18	80	85 ⁰ _{-0.3}	0.26
01 031 004	DR-C 27 x 40	16 ^{+0.5} _{-0.3}	20 ±0.4	45 ^{+0.4} ₀	27	40	45 ⁰ _{-0.3}	0.24
01 031 005	DR-C 27 x 60	16 ^{+0.5} _{-0.3}	20 ±0.4	45 ^{+0.4} ₀	27	60	65 ⁰ _{-0.3}	0.36
01 031 006	DR-C 27 x 100	16 ^{+0.5} _{-0.3}	20 ±0.4	45 ^{+0.4} ₀	27	100	105 ⁰ _{-0.3}	0.60
01 031 007	DR-C 38 x 60	20 ^{+0.5} _{-0.2}	25 ±0.4	60 ^{+0.3} _{-0.2}	38	60	70 ⁰ _{-0.3}	0.57
01 031 008	DR-C 38 x 80	20 ^{+0.5} _{-0.2}	25 ±0.4	60 ^{+0.3} _{-0.2}	38	80	90 ⁰ _{-0.3}	0.75
01 031 009	DR-C 38 x 120	20 ^{+0.5} _{-0.2}	25 ±0.4	60 ^{+0.3} _{-0.2}	38	120	130 ⁰ _{-0.3}	1.12
01 031 023	DR-C 45 x 80	24 ^{+0.5} _{-0.2}	35 ±0.5	75 ^{+0.3} _{-0.2}	45	80	90 ⁰ _{-0.3}	1.25
01 031 024	DR-C 45 x 100	24 ^{+0.5} _{-0.2}	35 ±0.5	75 ^{+0.3} _{-0.2}	45	100	110 ⁰ _{-0.3}	1.53
01 031 025	DR-C 50 x 120	30 ^{+0.5} _{-0.2}	40 ±0.5	80 ^{+0.3} _{-0.2}	50	120	130 ⁰ _{-0.3}	2.04
01 031 026	DR-C 50 x 200	30 ^{+0.5} _{-0.2}	40 ±0.5	80 ^{+0.3} _{-0.2}	50	200	210 ⁰ _{-0.3}	3.45

List of torque and loads on page 2.3.

If no other units are specified, the numbers given are in mm.

Rubber Suspension Element

DR-S

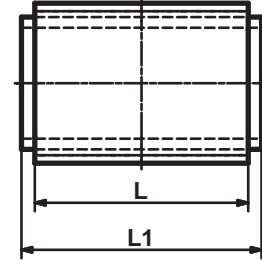
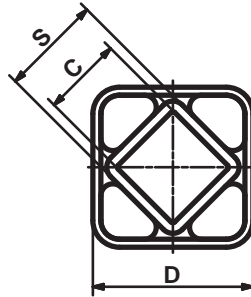
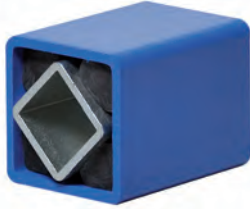

Part no.	Type	□C	□D	□S	L	L1	Weight [kg]
01 021 001	DR-S 11 × 20	8 ^{+0.25} ₀	20 ^{+0.3} _{-0.1}	11	20	25 ±0.2	0.04
01 021 002	DR-S 11 × 30	8 ^{+0.25} ₀	20 ^{+0.3} _{-0.1}	11	30	35 ±0.2	0.05
01 021 003	DR-S 11 × 50	8 ^{+0.25} ₀	20 ^{+0.3} _{-0.1}	11	50	55 ±0.2	0.08
01 021 004	DR-S 15 × 25	11 ^{+0.25} ₀	27 ^{+0.4} ₀	15	25	30 ±0.2	0.07
01 021 005	DR-S 15 × 40	11 ^{+0.25} ₀	27 ^{+0.4} ₀	15	40	45 ±0.2	0.12
01 021 006	DR-S 15 × 60	11 ^{+0.25} ₀	27 ^{+0.4} ₀	15	60	65 ±0.2	0.17
01 021 007	DR-S 18 × 30	12 ^{+0.25} ₀	32 ^{+0.3} _{-0.1}	18	30	35 ±0.2	0.13
01 021 008	DR-S 18 × 50	12 ^{+0.25} ₀	32 ^{+0.3} _{-0.1}	18	50	55 ±0.2	0.21
01 021 009	DR-S 18 × 80	12 ^{+0.25} ₀	32 ^{+0.3} _{-0.1}	18	80	85 ±0.2	0.33
01 021 010	DR-S 27 × 40	22 ^{+0.25} ₀	45 ^{+0.4} ₀	27	40	45 ±0.2	0.26
01 021 011	DR-S 27 × 60	22 ^{+0.25} ₀	45 ^{+0.4} ₀	27	60	65 ±0.2	0.39
01 021 012	DR-S 27 × 100	22 ^{+0.25} ₀	45 ^{+0.4} ₀	27	100	105 ±0.2	0.65
01 021 013	DR-S 38 × 60	30 ^{+0.25} ₀	60 ^{+0.3} _{-0.2}	38	60	70 ±0.2	0.65
01 021 014	DR-S 38 × 80	30 ^{+0.25} ₀	60 ^{+0.3} _{-0.2}	38	80	90 ±0.2	0.85
01 021 015	DR-S 38 × 120	30 ^{+0.25} ₀	60 ^{+0.3} _{-0.2}	38	120	130 ±0.2	1.25
01 021 026	DR-S 45 × 80	35 ^{+0.4} ₀	75 ^{+0.3} _{-0.2}	45	80	90 ±0.2	1.41
01 021 027	DR-S 45 × 100	35 ^{+0.4} ₀	75 ^{+0.3} _{-0.2}	45	100	110 ±0.2	1.75
01 021 028	DR-S 45 × 150	35 ^{+0.4} ₀	75 ^{+0.3} _{-0.2}	45	150	160 ±0.2	2.59
01 021 029	DR-S 50 × 120	40 ^{+0.4} ₀	80 ^{+0.3} _{-0.2}	50	120	130 ±0.2	2.30
01 021 030	DR-S 50 × 200	40 ^{+0.4} ₀	80 ^{+0.3} _{-0.2}	50	200	210 ±0.2	3.79
01 021 031	DR-S 50 × 300	40 ^{+0.4} ₀	80 ^{+0.3} _{-0.2}	50	300	310 ±0.2	5.66

List of torque and loads on page 2.3.

If no other units are specified, the numbers given are in mm.

Rubber Suspension Element

Bracket BR

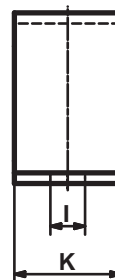
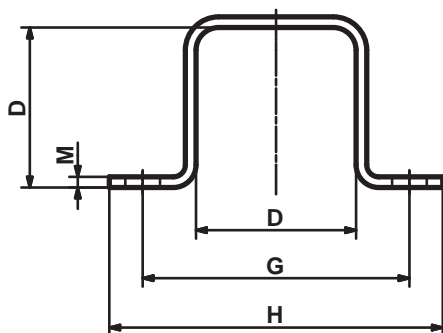

2

Part no.	Type	D	G	H	ø l	K	M	Weight [kg]
01 500 001	BR 11	20	37	50	6	20	2	0.02
01 500 002	BR 15	27	50	65	7	25	2	0.04
01 500 003	BR 18	32	60	80	9	30	2.5	0.08
01 500 004	BR 27	45	80	105	11	35	3	0.14
01 500 005	BR 38	60	100	125	13	40	4	0.27
01 500 026	BR 45	75	120	150	13	45	5	0.47
01 500 027	BR 50	80	135	175	18	50	6	0.70

If no other units are specified, the numbers given are in mm.

Rubber Suspension Element

DK-A

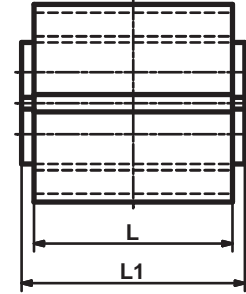
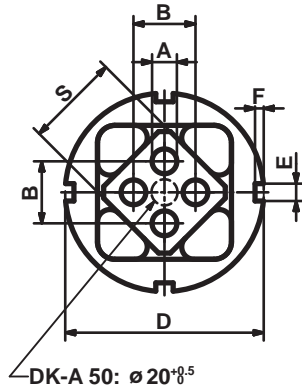

Part no.	Type	$\varnothing A$	B	$\varnothing D$	E	F	$\square S$	L	L1	Weight [kg]
01 071 001	DK-A 15 × 25	$5^{+0.5}_0$	$10_{\pm 0.2}$	$36^{+0.5}_{-0.1}$	5	2.5	15	25	$30^{+0.0}_{-0.3}$	0.05
01 071 002	DK-A 15 × 40	$5^{+0.5}_0$	$10_{\pm 0.2}$	$36^{+0.5}_{-0.1}$	5	2.5	15	40	$45^{+0.0}_{-0.3}$	0.08
01 071 003	DK-A 15 × 60	$5^{+0.5}_0$	$10_{\pm 0.2}$	$36^{+0.5}_{-0.1}$	5	2.5	15	60	$65^{+0.0}_{-0.3}$	0.12
01 071 004	DK-A 18 × 30	$6^{+0.5}_0$	$12_{\pm 0.3}$	$45^{+0.6}_{-0.1}$	5	2.5	18	30	$35^{+0.0}_{-0.3}$	0.10
01 071 005	DK-A 18 × 50	$6^{+0.5}_0$	$12_{\pm 0.3}$	$45^{+0.6}_{-0.1}$	5	2.5	18	50	$55^{+0.0}_{-0.3}$	0.16
01 071 006	DK-A 18 × 80	$6^{+0.5}_0$	$12_{\pm 0.3}$	$45^{+0.6}_{-0.1}$	5	2.5	18	80	$85^{+0.0}_{-0.3}$	0.25
01 071 007	DK-A 27 × 40	$8^{+0.5}_0$	$20_{\pm 0.4}$	$62^{+0.7}_{-0.1}$	6	3	27	40	$45^{+0.0}_{-0.3}$	0.25
01 071 008	DK-A 27 × 60	$8^{+0.5}_0$	$20_{\pm 0.4}$	$62^{+0.7}_{-0.1}$	6	3	27	60	$65^{+0.0}_{-0.3}$	0.37
01 071 009	DK-A 27 × 100	$8^{+0.5}_0$	$20_{\pm 0.4}$	$62^{+0.7}_{-0.1}$	6	3	27	100	$105^{+0.0}_{-0.3}$	0.61
01 071 010	DK-A 38 × 60	$10^{+0.5}_0$	$25_{\pm 0.4}$	$80^{+0.8}_{-0.1}$	7	3.5	38	60	$70^{+0.0}_{-0.3}$	0.62
01 071 011	DK-A 38 × 80	$10^{+0.5}_0$	$25_{\pm 0.4}$	$80^{+0.8}_{-0.1}$	7	3.5	38	80	$90^{+0.0}_{-0.3}$	0.82
01 071 012	DK-A 38 × 120	$10^{+0.5}_0$	$25_{\pm 0.4}$	$80^{+0.8}_{-0.1}$	7	3.5	38	120	$130^{+0.0}_{-0.3}$	1.22
01 071 013	DK-A 45 × 80	$12^{+0.5}_0$	$35_{\pm 0.5}$	$95^{+1.0}_{-0.1}$	8	4	45	80	$90^{+0.0}_{-0.3}$	1.14
01 071 014	DK-A 45 × 100	$12^{+0.5}_0$	$35_{\pm 0.5}$	$95^{+1.0}_{-0.1}$	8	4	45	100	$110^{+0.0}_{-0.3}$	1.41
01 071 015	DK-A 45 × 150	$12^{+0.5}_0$	$35_{\pm 0.5}$	$95^{+1.0}_{-0.1}$	8	4	45	150	$160^{+0.0}_{-0.3}$	2.11
01 071 016	DK-A 50 × 120	M12 × 40	$40_{\pm 0.5}$	$108^{+1.2}_{-0.1}$	8	4	50	120	$130^{+0.0}_{-0.3}$	2.26
01 071 017	DK-A 50 × 200	M12 × 40	$40_{\pm 0.5}$	$108^{+1.2}_{-0.1}$	8	4	50	200	$210^{+0.0}_{-0.3}$	3.74
01 071 018	DK-A 50 × 300	M12 × 40	$40_{\pm 0.5}$	$108^{+1.2}_{-0.1}$	8	4	50	300	$310^{+0.0}_{-0.3}$	5.62

List of torque and loads on page 2.3.

If no other units are specified, the numbers given are in mm.

Rubber Suspension Element

DK-S

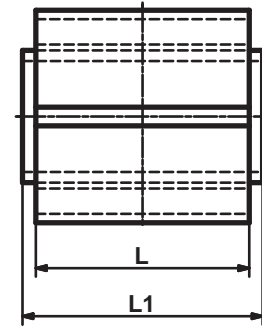
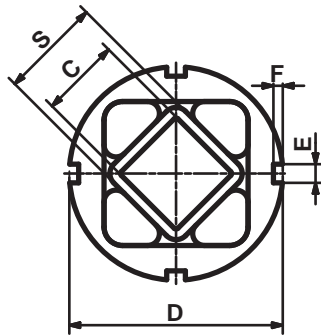
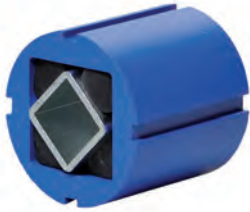

Part no.	Type	□C	∅D	E	F	□S	L	L1	Weight [kg]
01 081 001	DK-S 11 × 20	8 ^{+0.25} ₀	28 ^{+0.5} _{-0.1}	4	2.5	11	20	25 ±0.2	0.03
01 081 002	DK-S 11 × 30	8 ^{+0.25} ₀	28 ^{+0.5} _{-0.1}	4	2.5	11	30	35 ±0.2	0.04
01 081 003	DK-S 11 × 50	8 ^{+0.25} ₀	28 ^{+0.5} _{-0.1}	4	2.5	11	50	55 ±0.2	0.07
01 081 004	DK-S 15 × 25	11 ^{+0.25} ₀	36 ^{+0.5} _{-0.1}	5	2.5	15	25	30 ±0.2	0.06
01 081 005	DK-S 15 × 40	11 ^{+0.25} ₀	36 ^{+0.5} _{-0.1}	5	2.5	15	40	45 ±0.2	0.10
01 081 006	DK-S 15 × 60	11 ^{+0.25} ₀	36 ^{+0.5} _{-0.1}	5	2.5	15	60	65 ±0.2	0.14
01 081 007	DK-S 18 × 30	12 ^{+0.25} ₀	45 ^{+0.6} _{-0.1}	5	2.5	18	30	35 ±0.2	0.13
01 081 008	DK-S 18 × 50	12 ^{+0.25} ₀	45 ^{+0.6} _{-0.1}	5	2.5	18	50	55 ±0.2	0.21
01 081 009	DK-S 18 × 80	12 ^{+0.25} ₀	45 ^{+0.6} _{-0.1}	5	2.5	18	80	85 ±0.2	0.32
01 081 010	DK-S 27 × 40	22 ^{+0.25} ₀	62 ^{+0.7} _{-0.1}	6	3	27	40	45 ±0.2	0.27
01 081 011	DK-S 27 × 60	22 ^{+0.25} ₀	62 ^{+0.7} _{-0.1}	6	3	27	60	65 ±0.2	0.40
01 081 012	DK-S 27 × 100	22 ^{+0.25} ₀	62 ^{+0.7} _{-0.1}	6	3	27	100	105 ±0.2	0.66
01 081 013	DK-S 38 × 60	30 ^{+0.25} ₀	80 ^{+0.8} _{-0.1}	7	3.5	38	60	70 ±0.2	0.70
01 081 014	DK-S 38 × 80	30 ^{+0.25} ₀	80 ^{+0.8} _{-0.1}	7	3.5	38	80	90 ±0.2	0.92
01 081 015	DK-S 38 × 120	30 ^{+0.25} ₀	80 ^{+0.8} _{-0.1}	7	3.5	38	120	130 ±0.2	1.36
01 081 016	DK-S 45 × 80	35 ^{+0.4} ₀	95 ^{+1.0} _{-0.1}	8	4	45	80	90 ±0.2	1.30
01 081 017	DK-S 45 × 100	35 ^{+0.4} ₀	95 ^{+1.0} _{-0.1}	8	4	45	100	110 ±0.2	1.65
01 081 018	DK-S 45 × 150	35 ^{+0.4} ₀	95 ^{+1.0} _{-0.1}	8	4	45	150	160 ±0.2	2.38
01 081 019	DK-S 50 × 120	40 ^{+0.4} ₀	108 ^{+1.2} _{-0.1}	8	4	50	120	130 ±0.2	2.50
01 081 020	DK-S 50 × 200	40 ^{+0.4} ₀	108 ^{+1.2} _{-0.1}	8	4	50	200	210 ±0.2	4.14
01 081 021	DK-S 50 × 300	40 ^{+0.4} ₀	108 ^{+1.2} _{-0.1}	8	4	50	300	310 ±0.2	5.59

List of torque and loads on page 2.3.

If no other units are specified, the numbers given are in mm.

Rubber Suspension Element

Bracket BK

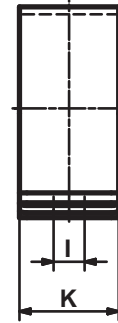
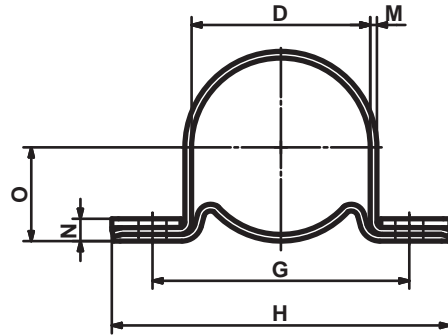

Part no.	Type	D	G	H	$\varnothing I$	K	M	N	O	Weight [kg]
01 520 001	BK 11	28	45	60	6.5	20	1.5	6	15.5	0.05
01 520 002	BK 15	36	55	75	6.5	25	2	7	20.0	0.09
01 520 003	BK 18	45	68	90	8.5	30	2	8	24.5	0.14
01 520 004	BK 27	62	92	125	10.5	35	2.5	10	33.5	0.28
01 520 005	BK 38	80	115	150	12.5	40	3	11	43.0	0.47
01 520 006	BK 45	95	130	165	12.5	45	4	14	51.5	0.77
01 520 007	BK 50	108	152	195	16.5	50	4	15	58.0	1.04

If no other units are specified, the numbers given are in mm.

With the BK bracket, the position of the DK element can be freely selected over 360°.

Rubber Suspension Element

DW-A 15 to 50

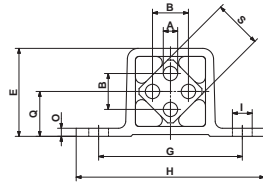

sizes 15 to 50 x 160

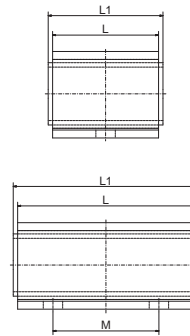

size 50 x 200

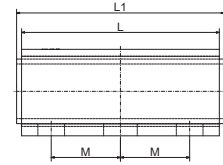

Part no.	Type	ϕA	B	E	G	H	ϕI	O	Q	$\square S$	L	L1	M	Weight [kg]
01 101 016	DW-A 15 x 25	5 ^{+0.5} ₀	10 \pm 0.2	29	50	65	7	3	15	15	25	30 ⁰ _{-0.3}	–	0.04
01 101 017	DW-A 15 x 40	5 ^{+0.5} ₀	10 \pm 0.2	29	50	65	7	3	15	15	40	45 ⁰ _{-0.3}	–	0.07
01 101 018	DW-A 15 x 60	5 ^{+0.5} ₀	10 \pm 0.2	29	50	65	7	3	15	15	60	65 ⁰ _{-0.3}	40	0.10
01 101 019	DW-A 18 x 30	6 ^{+0.5} ₀	12 \pm 0.3	35	60	80	9	3.5	18	18	30	35 ⁰ _{-0.3}	–	0.08
01 101 020	DW-A 18 x 50	6 ^{+0.5} ₀	12 \pm 0.3	35	60	80	9	3.5	18	18	50	55 ⁰ _{-0.3}	–	0.13
01 101 021	DW-A 18 x 80	6 ^{+0.5} ₀	12 \pm 0.3	35	60	80	9	3.5	18	18	80	85 ⁰ _{-0.3}	50	0.20
01 101 022	DW-A 27 x 40	8 ^{+0.5} ₀	20 \pm 0.4	49	80	105	11	4.5	25	27	40	45 ⁰ _{-0.3}	–	0.21
01 101 023	DW-A 27 x 60	8 ^{+0.5} ₀	20 \pm 0.4	49	80	105	11	4.5	25	27	60	65 ⁰ _{-0.3}	–	0.31
01 101 024	DW-A 27 x 100	8 ^{+0.5} ₀	20 \pm 0.4	49	80	105	11	4.5	25	27	100	105 ⁰ _{-0.3}	60	0.51
01 101 025	DW-A 38 x 60	10 ^{+0.5} ₀	25 \pm 0.4	67	100	125	13	6	34	38	60	70 ⁰ _{-0.3}	–	0.57
01 101 026	DW-A 38 x 80	10 ^{+0.5} ₀	25 \pm 0.4	67	100	125	13	6	34	38	80	90 ⁰ _{-0.3}	40	0.75
01 101 027	DW-A 38 x 120	10 ^{+0.5} ₀	25 \pm 0.4	67	100	125	13	6	34	38	120	130 ⁰ _{-0.3}	80	1.12
01 101 043	DW-A 45 x 80	12 ^{+0.5} ₀	35 \pm 0.5	81	115	145	13 x 27	9	41	45	80	90 ⁰ _{-0.3}	–	1.08
01 101 044	DW-A 45 x 100	12 ^{+0.5} ₀	35 \pm 0.5	81	115	145	13 x 27	9	41	45	100	110 ⁰ _{-0.3}	58	1.35
01 101 045	DW-A 45 x 150	12 ^{+0.5} ₀	35 \pm 0.5	81	115	145	13 x 27	9	41	45	150	160 ⁰ _{-0.3}	90	2.00
01 101 046	DW-A 50 x 120	M12 x 40	40 \pm 0.5	88	130	170	17 x 27	12	45	50	120	130 ⁰ _{-0.3}	60	1.91
01 101 047	DW-A 50 x 160	M12 x 40	40 \pm 0.5	88	130	170	17 x 27	12	45	50	160	170 ⁰ _{-0.3}	70	2.57
01 101 048	DW-A 50 x 200	M12 x 40	40 \pm 0.5	88	130	170	17 x 27	12	45	50	200	210 ⁰ _{-0.3}	70	3.18

List of torque and loads on page 2.3.

If no other units are specified, the numbers given are in mm.

Rubber Suspension Element

DW-A 60 to 100

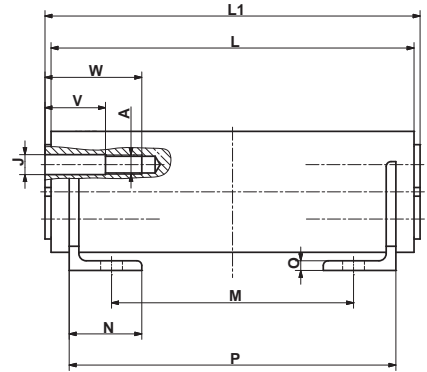
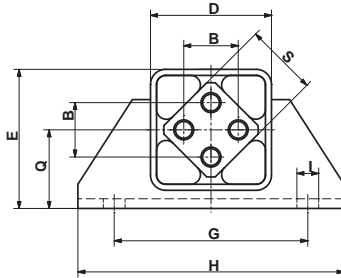

Part no.	Type	A	B	D	E	G	H	øI	øJ	N	O	Q	□S	V	W	L	L1	M	P	Weight [kg]
01 101 031	DW-A 60 × 150	M16	45	100	115	160	220	18	16.5	60	8	65	60	40	70	150	160 ±0.2	60	130	8.74
01 101 032	DW-A 60 × 200	M16	45	100	115	160	220	18	16.5	60	8	65	60	50	80	200	210 ±0.2	100	170	11.10
01 101 033	DW-A 60 × 300	M16	45	100	115	160	220	18	16.5	60	8	65	60	50	80	300	310 ±0.2	200	270	15.90
01 101 034	DW-A 70 × 200	M20	50	120	140	200	260	22	20.5	65	9	80	70	50	90	200	210 ±0.2	100	170	15.87
01 101 035	DW-A 70 × 300	M20	50	120	140	200	260	22	20.5	65	9	80	70	50	90	300	310 ±0.2	200	270	21.70
01 101 036	DW-A 70 × 400	M20	50	120	140	200	260	22	20.5	65	9	80	70	50	90	400	410 ±0.2	300	370	28.20
01 101 037	DW-A 80 × 200	M20	60	136	153	220	280	22	20.5	80	10	85	80	50	90	200	210 ±0.2	80	170	21.70
01 101 038	DW-A 80 × 300	M20	60	136	153	220	280	22	20.5	80	10	85	80	50	90	300	310 ±0.2	180	270	29.40
01 101 039	DW-A 80 × 400	M20	60	136	153	220	280	22	20.5	80	10	85	80	50	90	400	410 ±0.2	280	370	39.40
01 101 040	DW-A 100 × 250	M24	75	170	195	300	380	26	25	100	12	110	100	50	100	250	260 ±0.2	110	220	41.00
01 101 041	DW-A 100 × 400	M24	75	170	195	300	380	26	25	100	12	110	100	50	100	400	410 ±0.2	260	370	64.70
01 101 042	DW-A 100 × 500	M24	75	170	195	300	380	26	25	100	12	110	100	50	100	500	510 ±0.2	360	470	78.70

List of torque and loads on page 2.3.

If no other units are specified, the numbers given are in mm.

Rubber Suspension Element

DW-C

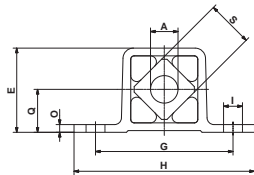

sizes 15 to 50 x 160

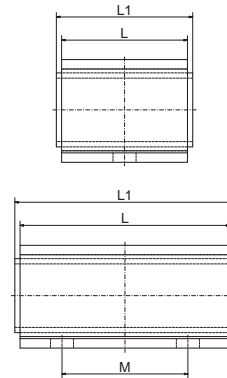

size 50 x 200

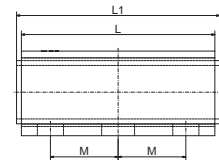

Part no.	Type	$\varnothing A$	E	G	H	$\varnothing I$	O	Q	$\square S$	L	L1	M	Weight [kg]
01 121 101	DW-C 15 x 25	10 ^{+0.4} _{-0.2}	29	50	65	7	3	15	15	25	30 ⁰ _{-0.3}	—	0.05
01 121 102	DW-C 15 x 40	10 ^{+0.4} _{-0.2}	29	50	65	7	3	15	15	40	45 ⁰ _{-0.3}	—	0.07
01 121 103	DW-C 15 x 60	10 ^{+0.4} _{-0.2}	29	50	65	7	3	15	15	60	65 ⁰ _{-0.3}	40	0.11
01 121 104	DW-C 18 x 30	13 ⁰ _{-0.2}	35	60	80	9	3.5	18	18	30	35 ⁰ _{-0.3}	—	0.08
01 121 105	DW-C 18 x 50	13 ⁰ _{-0.2}	35	60	80	9	3.5	18	18	50	55 ⁰ _{-0.3}	—	0.13
01 121 106	DW-C 18 x 80	13 ⁰ _{-0.2}	35	60	80	9	3.5	18	18	80	85 ⁰ _{-0.3}	50	0.20
01 121 107	DW-C 27 x 40	16 ^{+0.5} _{-0.3}	49	80	105	11	4.5	25	27	40	45 ⁰ _{-0.3}	—	0.21
01 121 108	DW-C 27 x 60	16 ^{+0.5} _{-0.3}	49	80	105	11	4.5	25	27	60	65 ⁰ _{-0.3}	—	0.31
01 121 109	DW-C 27 x 100	16 ^{+0.5} _{-0.3}	49	80	105	11	4.5	25	27	100	105 ⁰ _{-0.3}	60	0.50
01 121 110	DW-C 38 x 60	20 ^{+0.5} _{-0.2}	67	100	125	13	6	34	38	60	70 ⁰ _{-0.3}	—	0.58
01 121 111	DW-C 38 x 80	20 ^{+0.5} _{-0.2}	67	100	125	13	6	34	38	80	90 ⁰ _{-0.3}	40	0.76
01 121 112	DW-C 38 x 120	20 ^{+0.5} _{-0.2}	67	100	125	13	6	34	38	120	130 ⁰ _{-0.3}	80	1.13
01 121 113	DW-C 45 x 80	24 ^{+0.5} _{-0.2}	81	115	145	13 x 27	9	41	45	80	90 ⁰ _{-0.3}	—	1.10
01 121 114	DW-C 45 x 100	24 ^{+0.5} _{-0.2}	81	115	145	13 x 27	9	41	45	100	110 ⁰ _{-0.3}	58	1.35
01 121 115	DW-C 45 x 150	24 ^{+0.5} _{-0.2}	81	115	145	13 x 27	9	41	45	150	160 ⁰ _{-0.3}	90	2.00
01 121 116	DW-C 50 x 120	30 ^{+0.5} _{-0.2}	88	130	170	17 x 27	12	45	50	120	130 ⁰ _{-0.3}	60	1.90
01 121 117	DW-C 50 x 160	30 ^{+0.5} _{-0.2}	88	130	170	17 x 27	12	45	50	160	170 ⁰ _{-0.3}	70	2.50
01 121 118	DW-C 50 x 200	30 ^{+0.5} _{-0.2}	88	130	170	17 x 27	12	45	50	200	210 ⁰ _{-0.3}	70	3.10

List of torque and loads on page 2.3.

If no other units are specified, the numbers given are in mm.

Rubber Suspension Element

DW-S

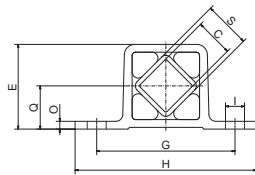

sizes 15 to 50 × 160

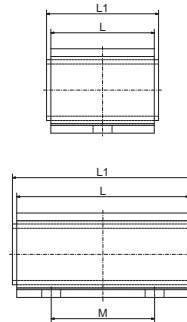

size 50 × 200

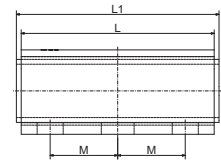

Part no.	Type	□C	E	G	H	∅I	O	Q	□S	L	L1	M	Weight [kg]
01 111 201	DW-S 15 × 25	11 ^{+0.25} ₀	29	50	65	7	3	15	15	25	30 ±0.2	–	0.06
01 111 202	DW-S 15 × 40	11 ^{+0.25} ₀	29	50	65	7	3	15	15	40	45 ±0.2	–	0.09
01 111 203	DW-S 15 × 60	11 ^{+0.25} ₀	29	50	65	7	3	15	15	60	65 ±0.2	40	0.13
01 111 204	DW-S 18 × 30	12 ^{+0.25} ₀	35	60	80	9	3.5	18	18	30	35 ±0.2	–	0.13
01 111 205	DW-S 18 × 50	12 ^{+0.25} ₀	35	60	80	9	3.5	18	18	50	55 ±0.2	–	0.11
01 111 206	DW-S 18 × 80	12 ^{+0.25} ₀	35	60	80	9	3.5	18	18	80	85 ±0.2	50	0.27
01 111 207	DW-S 27 × 40	22 ^{+0.25} ₀	49	80	105	11	4.5	25	27	40	45 ±0.2	–	0.22
01 111 208	DW-S 27 × 60	22 ^{+0.25} ₀	49	80	105	11	4.5	25	27	60	65 ±0.2	–	0.33
01 111 209	DW-S 27 × 100	22 ^{+0.25} ₀	49	80	105	11	4.5	25	27	100	105 ±0.2	60	0.56
01 111 210	DW-S 38 × 60	30 ^{+0.25} ₀	67	100	125	13	6	34	38	60	70 ±0.2	–	0.65
01 111 211	DW-S 38 × 80	30 ^{+0.25} ₀	67	100	125	13	6	34	38	80	90 ±0.2	40	0.85
01 111 212	DW-S 38 × 120	30 ^{+0.25} ₀	67	100	125	13	6	34	38	120	130 ±0.2	80	1.27
01 111 213	DW-S 45 × 80	35 ^{+0.4} ₀	81	115	145	13 × 27	9	41	45	80	90 ±0.2	–	1.26
01 111 214	DW-S 45 × 100	35 ^{+0.4} ₀	81	115	145	13 × 27	9	41	45	100	110 ±0.2	58	1.60
01 111 215	DW-S 45 × 150	35 ^{+0.4} ₀	81	115	145	13 × 27	9	41	45	150	160 ±0.2	90	2.30
01 111 216	DW-S 50 × 120	40 ^{+0.4} ₀	88	130	170	17 × 27	12	45	50	120	130 ±0.2	60	2.16
01 111 217	DW-S 50 × 160	40 ^{+0.4} ₀	88	130	170	17 × 27	12	45	50	160	170 ±0.2	70	2.87
01 111 218	DW-S 50 × 200	40 ^{+0.4} ₀	88	130	170	17 × 27	12	45	50	200	210 ±0.2	70	3.55

List of torque and loads on page 2.3.

If no other units are specified, the numbers given are in mm.

Rubber Suspension Element

DO-A



sizes 15 to 45

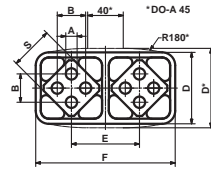

sizes 15 to 45

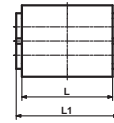

size 50

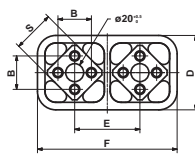

size 50

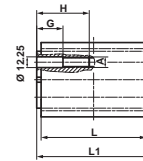

Part no.	Type	$\varnothing A$	B	D	E	F	$\square S$	G	H	L	L1	Weight [kg]
01 041 001	DO-A 15 x 25	5 ^{+0.5} ₀	10 ±0.2	28	25.5	53.5	15	–	–	25	30 ⁰ _{-0.3}	0.07
01 041 002	DO-A 15 x 40	5 ^{+0.5} ₀	10 ±0.2	28	25.5	53.5	15	–	–	40	45 ⁰ _{-0.3}	0.11
01 041 003	DO-A 15 x 60	5 ^{+0.5} ₀	10 ±0.2	28	25.5	53.5	15	–	–	60	65 ⁰ _{-0.3}	0.15
01 041 004	DO-A 18 x 30	6 ^{+0.5} ₀	12 ±0.3	34	31	65	18	–	–	30	35 ⁰ _{-0.3}	0.12
01 041 005	DO-A 18 x 50	6 ^{+0.5} ₀	12 ±0.3	34	31	65	18	–	–	50	55 ⁰ _{-0.3}	0.20
01 041 006	DO-A 18 x 80	6 ^{+0.5} ₀	12 ±0.3	34	31	65	18	–	–	80	85 ⁰ _{-0.3}	0.31
01 041 007	DO-A 27 x 40	8 ^{+0.5} ₀	20 ±0.4	47	44	91	27	–	–	40	45 ⁰ _{-0.3}	0.32
01 041 008	DO-A 27 x 60	8 ^{+0.5} ₀	20 ±0.4	47	44	91	27	–	–	60	65 ⁰ _{-0.3}	0.47
01 041 009	DO-A 27 x 100	8 ^{+0.5} ₀	20 ±0.4	47	44	91	27	–	–	100	105 ⁰ _{-0.3}	0.76
01 041 010	DO-A 38 x 60	10 ^{+0.5} ₀	25 ±0.4	63	60	123	38	–	–	60	70 ⁰ _{-0.3}	0.88
01 041 011	DO-A 38 x 80	10 ^{+0.5} ₀	25 ±0.4	63	60	123	38	–	–	80	90 ⁰ _{-0.3}	1.14
01 041 012	DO-A 38 x 120	10 ^{+0.5} ₀	25 ±0.4	63	60	123	38	–	–	120	130 ⁰ _{-0.3}	1.69
01 041 013	DO-A 45 x 80	12 ^{+0.5} ₀	35 ±0.5	85	73	150	45	–	–	80	90 ⁰ _{-0.3}	1.84
01 041 014	DO-A 45 x 100	12 ^{+0.5} ₀	35 ±0.5	85	73	150	45	–	–	100	110 ⁰ _{-0.3}	2.27
01 041 015	DO-A 45 x 150	12 ^{+0.5} ₀	35 ±0.5	85	73	150	45	–	–	150	160 ⁰ _{-0.3}	3.37
01 041 026	DO-A 50 x 120	M12	40 ±0.5	89	78	167	50	30	60	120	130 ⁰ _{-0.3}	3.30
01 041 029	DO-A 50 x 160	M12	40 ±0.5	89	78	167	50	30	60	160	170 ⁰ _{-0.3}	4.40
01 041 027	DO-A 50 x 200	M12	40 ±0.5	89	78	167	50	40	70	200	210 ⁰ _{-0.3}	5.50

List of torque and loads on page 2.3.

If no other units are specified, the numbers given are in mm.

Material structure: DO-A 50 available with nodular cast iron housings on request

Rubber Suspension Element

Bracket WS

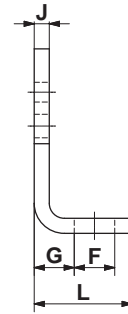
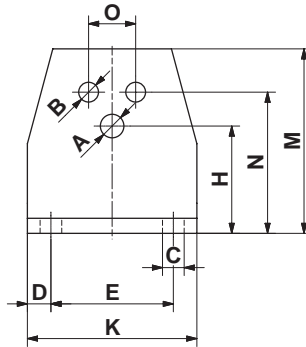

Part no.	Type	Fit for tensioner devices			Fit for DR-A, DK-A, DW-A														Weight [kg]
		SE nominal size	ϕ A	H	Element nominal size	ϕ B	N	O	C	D	E	F	G	J	K	L	M		
06 590 001	WS 11-15	11	6.5	27	15	5.5	35	10	7	7.5	30	13	11.5	4	45	30	46	0.08	
06 590 002	WS 15-18	15	8.5	34	18	6.5	44	12	7	7.5	40	13	13.5	5	55	32	58	0.15	
06 590 003	WS 18-27	18	10.5	43	27	8.5	55	20	9.5	10	50	15.5	16.5	6	70	38	74	0.30	
06 590 004	WS 27-38	27	12.5	57	38	10.5	75	25	11.5	12.5	65	21.5	21	8	90	52	98	0.66	
06 590 005	WS 38-45	38	16.5	66	45	12.5	85	35	14	15	80	24	21	8	110	55	116	0.94	
06 590 006	WS 45-50	45	20.5	80	50	12.5	110	40	18	20	100	30	26	10	140	66	140	1.74	

If no other units are specified, the numbers given are in mm.



OSCILLATING MOUNTINGS

Elastic suspensions for all types of screening machines, shaker conveyors and gyratory sifters

- Components for all types of vibrating machines and conveyors
- Vibration-damping mountings for circular and linear vibrating screens
- Double rocker arms for high-speed vibrating conveyor troughs
- Spring accumulators for machines in near-resonant operation
- Rocker arms and push rod heads for sliding-crank gutters
- Universal joint bearings for gyratory sifter screening machines
- Spring accumulator for resonance-based operation

Product advantages:



long service life

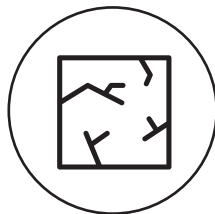



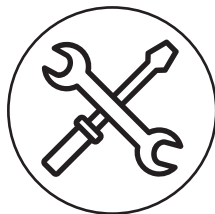







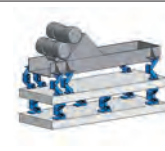

shatterproof





maintenance-free

Selection tables Oscillating Mountings

						
		One mass system circular motion screen	One mass system linear motion screen	Two mass system with counterframe	One mass system linear motion screen hanging	
		Illustration	Type	Description		Page
Elements for free oscillating systems (with unbalanced excitation)		AB ABI	Oscillating Mounting – universal mounting. High vibration isolation and low residual force transmission. Natural frequencies approx. 2–3 Hz. 9 element sizes from 50 N to 20 000 N.			3.4– 3.5
		AB-HD ABI-HD	Oscillating Mounting for impact loading and high production peaks (Heavy Duty). Natural frequencies approx. 2–4 Hz. 11 element sizes from 150 N to 60 000 N.			3.6– 3.7
		HS HSI			Oscillating Mounting for hanging systems. Natural frequencies approx. 3–5 Hz. 7 element sizes from 150 N to 14 000 N.	3.8
		AB-D		Oscillating Mounting in compact design. Optimal in two mass systems as counter- frame mounting. Natural frequencies approx. 3–4.5 Hz. 7 element sizes from 500 N to 16 000 N.		3.9

					
		Gyratary sifter upright staying	Gyratary sifter hanging		
		Illustration	Type	Description	Page
Elements for gyratary sifters		AK	Universal joint for the support or suspension of positive drive or freely oscillating gyratary sifting machines. 10 element sizes up to 40 000 N per AK.		3.19
		AV	Single joint specially designed with a large rubber volume for the suspended gyratary sifters. Models with right-hand and left-hand threads. 5 element sizes up to 16 000 N per AV.		3.20

		
One mass system «brute-force» system	One mass system «natural frequency» system	Two mass system «fast-runner» system with reaction force compensation

Elements for guided systems (crank driven)	Illustration	Type	Description	Page	
		AU AUI	Single Rocker for a variable arm length. Models with right-hand and left-hand threads. 7 element sizes up to 5 000 N.		3.10
		AS-P AS-C	Single rocker with standardized center distance. 6 sizes up to 2 500 N for flange fixation. 6 element sizes up to 2 500 N for central fixation.		3.11 – 3.12
		AD-P AD-C		Double rocker with standardized center distance. 5 element sizes up to 2 500 N for flange fixation. 4 element sizes up to 1 600 N for central fixation.	3.13 – 3.14
		AR	Single rocker and double rocker with adjustable length, connection of the AR elements using round pipe. Two mass shakers with bi-direction flow are simply to realize. 3 element sizes up to 1 600 N.		3.15
		ST STI	Drive Head for crank drive transmission. Models with right-hand and left-hand threads. 9 element sizes up to 27 000 N.		3.16 – 3.17
		DO-A		Spring accumulator with high dynamic spring value for feeder systems running close to resonance frequency. A spring accumulator consists of 2 DO-A elements. 5 element sizes up to dynamic spring value of 320 N/mm.	3.18

Oscillating Mountings

AB / ABI

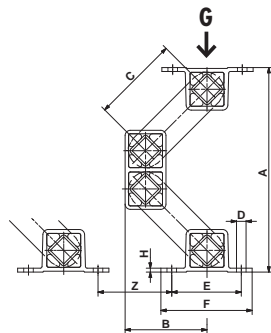

sizes 15 to 50

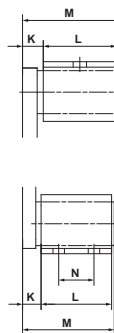

size 50-2

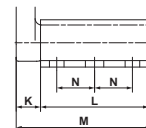

3

Part no.	Type	Load $G_{min.} - G_{max.}$ [N]	A un- loaded	A* max. load	B un- loaded	B* max. load	C	D	E	F	H	K	L	M	N	Weight [kg]
07 051 056	AB 15	50-160	168	114	70	88	80	∅7	50	65	3	10	40	52	-	0.5
07 171 107	ABI 15	70-180	168	114	70	88	80	7×10	50	65	3	10	40	52	-	0.8
07 051 057	AB 18	120-350	208	146	88	109	100	∅9	60	80	3.5	14	50	67	-	1.2
07 171 114	ABI 18	120-350	208	146	88	109	100	9×15	60	80	3.5	14	50	67	-	1.6
07 051 058	AB 27	250-800	235	170	94	116	100	∅11	80	105	4.5	17	60	80	-	2.3
07 171 109	ABI 27	250-800	235	170	94	116	100	11×20	80	105	4.5	17	60	80	-	3.4
07 051 059	AB 38	600-1600	305	225	120	147	125	∅13	100	125	6	21	80	104	40	5.1
07 171 110	ABI 38	600-1600	305	225	120	147	125	13×20	100	125	6	21	80	104	40	7.6
07 051 042	AB 45	1200-3000	353	257	141	172	140	13×27	115	145	9	28	100	132	58	9.5
07 171 111	ABI 45	1200-3000	353	257	137	168	140	13×26	115	145	8	28	100	132	58	13.6
07 051 043	AB 50	2500-6000	380	277	150	184	150	17×27	130	170	12	35	120	160	60	14.5
07 171 112	ABI 50	2500-6000	380	277	150	184	150	17×27	130	170	12	35	120	160	60	22.2
07 051 044	AB 50-2	4200-10000	380	277	150	184	150	17×27	130	170	12	40	200	245	70	22.5
07 171 113	ABI 50-2	4200-10000	380	277	150	184	150	17×27	130	170	12	40	200	245	70	35.2

Part no.	Type	Natural frequency $G_{min.} - G_{max.}$ [Hz]	Z	Dynamic spring value		Operating parameters by rpm						Material structure				
				vertical [N/mm]	horizontal [N/mm]	720 min ⁻¹		960 min ⁻¹		1440 min ⁻¹		Aluminium profile	steel welded construction	Nodular cast iron	painted blue	stainless steel casting
						sw	K	sw	K	sw	K					
07 051 056	AB 15	4.0-2.8	65	10	6	14	4.1	12	6.2	8	9.3	×	×	×		
07 171 107	ABI 15	4.0-2.8	65	10	6	14	4.1	12	6.2	8	9.3				×	
07 051 057	AB 18	3.7-2.6	80	20	14	17	4.9	15	7.7	8	9.3	×	×	×		
07 171 114	ABI 18	3.7-2.6	80	20	14	17	4.9	15	7.7	8	9.3				×	
07 051 058	AB 27	3.7-2.7	80	40	25	17	4.9	14	7.2	8	9.3	×	×	×		
07 171 109	ABI 27	3.7-2.7	80	40	25	17	4.9	14	7.2	8	9.3				×	
07 051 059	AB 38	3.0-2.4	100	60	30	20	5.8	17	8.8	8	9.3	×	×	×		
07 171 110	ABI 38	3.0-2.4	100	60	30	20	5.8	17	8.8	8	9.3				×	
07 051 042	AB 45	2.8-2.3	115	100	50	21	6.1	18	9.3	8	9.3	×	×	×		
07 171 111	ABI 45	2.8-2.3	115	100	50	21	6.1	18	9.3	8	9.3				×	
07 051 043	AB 50	2.4-2.1	140	190	85	22	6.4	18	9.3	8	9.3	×		×	×	
07 171 112	ABI 50	2.4-2.1	140	190	85	22	6.4	18	9.3	8	9.3				×	
07 051 044	AB 50-2	2.4-2.1	140	320	140	22	6.4	18	9.3	8	9.3	×		×	×	
07 171 113	ABI 50-2	2.4-2.1	140	320	140	22	6.4	18	9.3	8	9.3				×	

* compression load $G_{max.}$ and cold flow compensation (after approx. 1 year).

If no other units are specified, the numbers given are in mm.

Dynamic spring value: Values in nominal load range at 960 min⁻¹ and 8 mm of oscillating stroke sw

Operating parameters by rpm: Acceleration > 9.3g is not recommended

Material structure: AB50 and AB50-2 available with nodular cast iron housings on request

Oscillating Mountings

AB TWIN

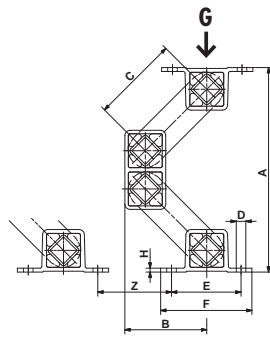

size 50 TWIN

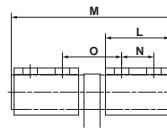

size 50-2 TWIN

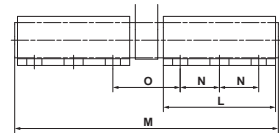

Part no.	Type	Load $G_{min.} - G_{max.}$ [N]	A un- loaded	A* max. load	B un- loaded	B* max. load	C	D	E	F	H	L	M	N	O	Weight [kg]
07 051 046	AB 50 TWIN	5 000–12 000	380	277	150	184	150	17 × 27	130	170	12	120	300	60	110	26.5
07 051 047	AB 50-2 TWIN	8 400–20 000	380	277	150	184	150	17 × 27	130	170	12	200	470	70	120	40.7

Part no.	Type	Natural frequency $G_{min.} - G_{max.}$ [Hz]	Z	Dynamic spring value cd		Operating parameters by rpm						Material structure
				vertical [N/mm]	horizontal [N/mm]	720 min ⁻¹		960 min ⁻¹		1 440 min ⁻¹		
						sw [mm]	K [-]	sw [mm]	K [-]	sw [mm]	K [-]	
07 051 046	AB 50 TWIN	2.4–2.1	140	380	170	22	6.4	18	9.3	8	9.3	steel welded inner parts, aluminium housings, painted blue
07 051 047	AB 50-2 TWIN	2.4–2.1	140	640	280	22	6.4	18	9.3	8	9.3	

* compression load $G_{max.}$ and cold flow compensation (after approx. 1 year).

If no other units are specified, the numbers given are in mm.

Dynamic spring value: Values in nominal load range at 960 min⁻¹ and 8 mm of oscillating stroke sw

Operating parameters by rpm: Acceleration > 9.3 g is not recommended

Material structure: Nodular cast iron housings available on request

Oscillating Mountings

AB-HD / ABI-HD sizes 15 to 50-2

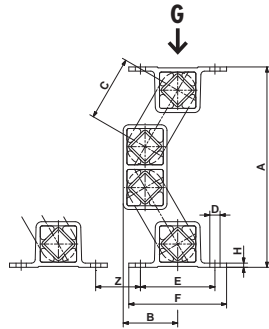

sizes 15 to 50-1.6



size 50-2

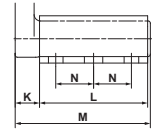

3

Part no.	Type	Load $G_{min.} - G_{max.}$ [N]	A un- loaded	A* max. load	B un- loaded	B* max. load	C	D	E	F	H	K	L	M	N	Weight [kg]
07 171 121	ABI-HD 15	150–400	132	107	36	50	45	7 × 10	50	65	3	10	40	52	–	0.8
07 171 128	ABI-HD 18	300–700	171	141	47	64	60	9 × 15	60	80	3.5	14	50	67	–	1.5
07 051 070	AB-HD 27	500–1250	215	182	59	78	70	∅11	80	105	4.5	17	60	80	–	2.0
07 171 123	ABI-HD 27	500–1250	215	182	59	78	70	11 × 20	80	105	4.5	17	60	80	–	3.4
07 051 071	AB-HD 38	1200–2500	293	246	79	106	95	∅13	100	125	6	21	80	104	40	4.9
07 171 124	ABI-HD 38	1200–2500	293	246	79	106	95	13 × 20	100	125	6	21	80	104	40	7.6
07 051 082	AB-HD 45	2000–4200	346	290	98	130	110	13 × 27	115	145	9	28	100	132	58	9.0
07 171 125	ABI-HD 45	2000–4200	346	290	94	126	110	13 × 26	115	145	8	28	100	132	58	13.8
07 051 083	AB-HD 50	3500–8400	376	313	105	141	120	17 × 27	130	170	12	40	120	165	60	15.1
07 171 126	ABI-HD 50	3500–8400	376	313	105	141	120	17 × 27	130	170	12	40	120	165	60	21.7
07 051 084	AB-HD 50-1.6	4800–11300	376	313	105	141	120	17 × 27	130	170	12	45	160	210	70	19.5
07 051 085	AB-HD 50-2	6000–14000	376	313	105	141	120	17 × 27	130	170	12	45	200	250	70	23.0
07 171 127	ABI-HD 50-2	6000–14000	376	313	105	141	120	17 × 27	130	170	12	45	200	250	70	35.8

Part no.	Type	Natural frequency $G_{min.} - G_{max.}$ [Hz]	Z	Dynamic spring value		Operating parameters by rpm						Material structure				
				vertical [N/mm]	horizontal [N/mm]	720 min ⁻¹		960 min ⁻¹		1440 min ⁻¹		Aluminium profile	steel welded construction	Nodular cast iron	painted blue	stainless steel casting
						cd	cd	sw	K	sw	K					
07 171 121	ABI-HD 15	5.8–3.6	35	18	10	8	2.3	7	3.6	5	5.8					×
07 171 128	ABI-HD 18	4.9–3.2	50	32	20	10	2.9	9	4.6	7	8.1					×
07 051 070	AB-HD 27	4.8–3.1	60	70	33	12	3.5	10	5.2	8	9.3	×	×		×	
07 171 123	ABI-HD 27	4.8–3.1	60	70	33	12	3.5	10	5.2	8	9.3					×
07 051 071	AB-HD 38	3.6–2.7	90	100	48	15	4.3	13	6.7	8	9.3	×	×		×	
07 171 124	ABI-HD 38	3.6–2.7	90	100	48	15	4.3	13	6.7	8	9.3					×
07 051 082	AB-HD 45	3.3–2.5	100	150	72	17	4.9	14	7.2	8	9.3	×	×		×	
07 171 125	ABI-HD 45	3.3–2.5	100	150	72	17	4.9	14	7.2	8	9.3					×
07 051 083	AB-HD 50	3.2–2.4	120	270	130	18	5.2	15	7.7	8	9.3	×		×	×	
07 171 126	ABI-HD 50	3.2–2.4	120	270	130	18	5.2	15	7.7	8	9.3					×
07 051 084	AB-HD 50-1.6	3.2–2.4	120	360	172	18	5.2	15	7.7	8	9.3	×	×	×	×	
07 051 085	AB-HD 50-2	3.2–2.4	120	450	215	18	5.2	15	7.7	8	9.3	×		×	×	
07 171 127	ABI-HD 50-2	3.2–2.4	120	450	215	18	5.2	15	7.7	8	9.3					×

* compression load $G_{max.}$ and cold flow compensation (after approx. 1 year).

If no other units are specified, the numbers given are in mm.

Dynamic spring value: Values in nominal load range at 960 min⁻¹ and 8 mm of oscillating stroke sw

Operating parameters by rpm: Acceleration > 9.3g is not recommended

Material structure: AB-HD 50, 50-1.6, 50-2 available with nodular cast iron housings on request

Oscillating Mountings

AB-HD sizes 70-3 to 100-4

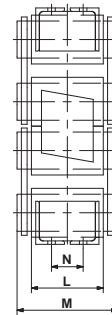
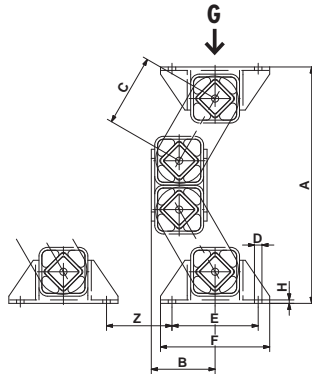

Part no.	Type	Load $G_{min.} - G_{max.}$ [N]	A un- loaded	A* max. load	B un- loaded	B* max. load	C	$\varnothing D$	E	F	H	L	M	N	Weight [kg]
07 051 076	AB-HD 70-3	9 000–20 000	592	494	160	215	180	22	200	260	9	300	380	200	82
07 051 080	AB-HD 100-2.5	15 000–37 000	823	676	222	302	250	26	300	380	12	250	350	110	170
07 051 081	AB-HD 100-4	25 000–60 000	823	676	222	302	250	26	300	380	12	400	500	260	230

Part no.	Type	Natural frequency $G_{min.} - G_{max.}$ [Hz]	Z	Dynamic spring value cd		Operating parameters by rpm						Material structure
				vertical [N/mm]	horizontal [N/mm]	720 min^{-1}		960 min^{-1}		$1 440 \text{ min}^{-1}$		
						sw [mm]	K [–]	sw [mm]	K [–]	sw [mm]	K [–]	
07 051 076	AB-HD 70-3	2.4–2.1	200	670	320	25	7.3	18	9.3	8	9.3	steel welded construction, painted blue
07 051 080	AB-HD 100-2.5	2.4–1.8	250	1 150	530	30	8.6	18	9.3	8	9.3	
07 051 081	AB-HD 100-4	2.4–1.8	250	1 840	850	30	8.6	18	9.3	8	9.3	

* compression load $G_{max.}$ and cold flow compensation (after approx. 1 year).

If no other units are specified, the numbers given are in mm.

Customized Oscillating Mountings Type AB-HD with low natural frequency and high load capacity.

The sizes 100-2.5 to AB-HD 100-4 can be combined with one another (identical heights and operation behaviour).

Dynamic spring value: Values in nominal load range at 960 min^{-1} and 8 mm of oscillating stroke sw

Operating parameters by rpm: Acceleration $> 9.3g$ is not recommended

Oscillating Mountings

HS / HSI

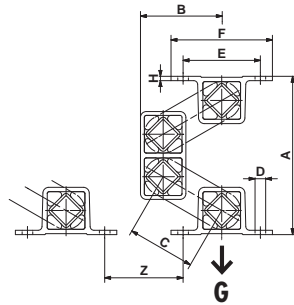

sizes 15 to 50



size 50-2

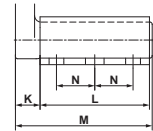

Part no.	Type	Load $G_{min.} - G_{max.}$ [N]	A un- loaded	A* max. load	B un- loaded	B* max. load	C	D	E	F	H	K	L	M	N	Weight [kg]
07 321 101	HSI 15	150–400	99	125	53	42	45	∅7	50	65	3	10	40	52	25	0.8
07 321 102	HSI 18	300–700	127	159	69	56	60	∅9	60	80	3.5	14	50	67	30	1.5
07 311 001	HS 27	500–1 250	164	202	84	68	70	∅11	80	105	4.5	17	60	80	35	2.0
07 321 103	HSI 27	500–1 250	164	202	84	68	70	∅11	80	105	4.5	17	60	80	35	3.4
07 311 002	HS 38	1 200–2 500	223	275	114	92	95	∅13	100	125	6	21	80	104	40	4.8
07 321 104	HSI 38	1 200–2 500	223	275	114	92	95	13×20	100	125	6	21	80	104	40	7.3
07 311 013	HS 45	2 000–4 200	265	325	138	113	110	13×27	115	145	9	28	100	132	58	9.0
07 321 105	HSI 45	2 000–4 200	265	325	134	109	110	13×26	115	145	8	28	100	132	58	13.6
07 311 014	HS 50	3 500–8 400	288	357	148	118	120	17×27	130	170	12	40	120	165	60	15.1
07 321 106	HSI 50	3 500–8 400	288	357	148	118	120	17×27	130	170	12	40	120	165	60	22.3
07 311 015	HS 50-2	6 000–14 000	288	357	148	118	120	17×27	130	170	12	45	200	250	70	23.0
07 321 107	HSI 50-2	6 000–14 000	288	357	148	118	120	17×27	130	170	12	45	200	250	70	35.8

Part no.	Type	Natural frequency $G_{min.} - G_{max.}$ [Hz]	Z	Dynamic spring value		Operating parameters by rpm						Material structure				
				vertical [N/mm]	horizontal [N/mm]	720 min ⁻¹		960 min ⁻¹		1440 min ⁻¹		Aluminium profile	steel welded construction	Nodular cast iron	painted blue	stainless steel casting
						sw [mm]	K max. [-]	sw [mm]	K max. [-]	sw [mm]	K max. [-]					
07 321 101	HSI 15	5.2–4.7	35	17	10	8	2.3	7	3.6	5	5.8					×
07 321 102	HSI 18	4.5–4.0	50	30	19	10	2.9	9	4.6	7	8.1					×
07 311 001	HS 27	4.2–3.8	60	65	32	12	3.5	10	5.2	8	9.3	×	×		×	
07 321 103	HSI 27	4.2–3.8	60	65	32	12	3.5	10	5.2	8	9.3					×
07 311 002	HS 38	3.6–3.3	90	95	46	15	4.3	13	6.7	8	9.3	×	×		×	
07 321 104	HSI 38	3.6–3.3	90	95	46	15	4.3	13	6.7	8	9.3					×
07 311 013	HS 45	3.3–3.0	100	142	70	17	4.9	14	7.2	8	9.3	×	×		×	
07 321 105	HSI 45	3.3–3.0	100	142	70	17	4.9	14	7.2	8	9.3					×
07 311 014	HS 50	3.2–2.9	120	245	120	18	5.2	15	7.7	8	9.3	×		×	×	
07 321 106	HSI 50	3.2–2.9	120	245	120	18	5.2	15	7.7	8	9.3					×
07 311 015	HS 50-2	3.2–2.9	120	410	200	18	5.2	15	7.7	8	9.3	×		×	×	
07 321 107	HSI 50-2	3.2–2.9	120	410	200	18	5.2	15	7.7	8	9.3					×

* tensile load $G_{max.}$ and cold flow compensation (after approx. 1 year).

If no other units are specified, the numbers given are in mm.

Dynamic spring value: Values in nominal load range at 960 min⁻¹ and 8 mm of oscillating stroke sw

Operating parameters by rpm: Acceleration > 9.3 g is not recommended

Material structure: HS 50 and HS 50-2 available with nodular cast iron housings on request

Oscillating Mountings

AB-D

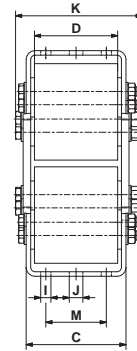
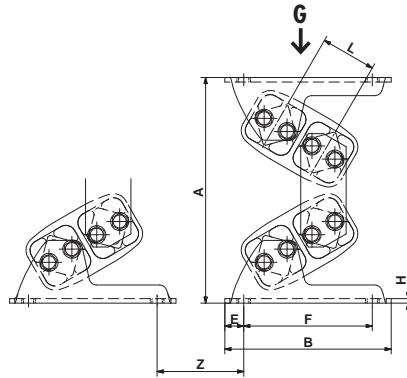

Part no.	Type	Load $G_{min.} - G_{max.}$ [N]	A un- loaded	A* max. load	B	C	D	E	F	H	I	J	K	L	M	Weight [kg]
07 281 000	AB-D 18	500–1 200	137	112	115	61	50	12.5	90	3	9	9	74	31	30	1.1
07 281 001	AB-D 27	1 000–2 500	184	148	150	93	80	15	120	4	9	11	116	44	50	3.1
07 281 002	AB-D 38	2 000–4 000	244	199	185	118	100	17.5	150	5	11	13.5	147	60	70	6.8
07 281 003	AB-D 45	3 000–6 000	298	240	220	132	110	25	170	6	13.5	18	168	73	80	11.2
07 281 004	AB-D 50	4 000–9 000	329	272	235	142	120	25	185	6	13.5	18	166	78	90	13.8
07 281 005	AB-D 50-1.6	6 000–12 000	329	272	235	186	160	25	185	8	13.5	18	214	78	90	18.5
07 281 006	AB-D 50-2	8 000–16 000	329	272	235	226	200	25	185	8	13.5	18	260	78	90	22.5

Part no.	Type	Natural frequency $G_{min.} - G_{max.}$ [Hz]	Z	Dynamic spring value			Operating parameters by rpm						Material structure (zinc-plated couplings)		
				vertical [N/mm]	at sw [N/mm]	horizontal [N/mm]	720 min ⁻¹		960 min ⁻¹		1 440 min ⁻¹		Aluminium profile	Steel plate	painted blue
							cd	cd	cd	sw	K	sw			
07 281 000	AB-D 18	6.1–4.4	30	100	4	20	5	1.4	5	2.6	4	4.6	×	×	×
07 281 001	AB-D 27	5.4–3.9	35	160	4	35	7	2.0	6	3.1	5	5.8	×	×	partially
07 281 002	AB-D 38	4.3–3.4	40	185	6	40	9	2.6	8	4.1	6	7.0	×	×	partially
07 281 003	AB-D 45	3.7–3.1	55	230	8	70	11	3.2	9	4.6	7	8.1	×	×	partially
07 281 004	AB-D 50	3.7–2.9	55	310	8	120	12	3.5	10	5.2	8	9.3	×	×	×
07 281 005	AB-D 50-1.6	3.6–2.9	55	430	8	160	12	3.5	10	5.2	8	9.3	×	×	×
07 281 006	AB-D 50-2	3.5–2.8	55	540	8	198	12	3.5	10	5.2	8	9.3	×	×	×

* compression load $G_{max.}$ and cold flow compensation (after approx. 1 year).

If no other units are specified, the numbers given are in mm.

Dynamic spring value: Values in nominal load range at 960 min⁻¹

Operating parameters by rpm: Acceleration > 9.3 g is not recommended

Oscillating Mountings

AU / AUI

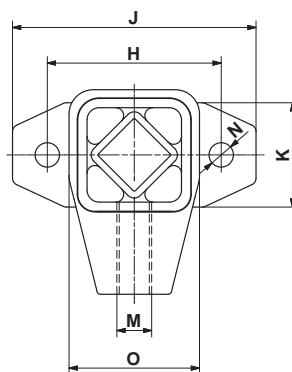
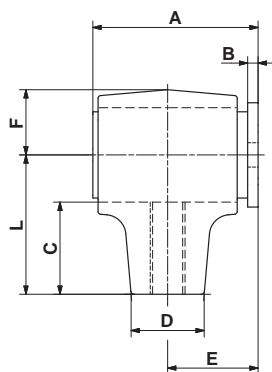

Fixation flange AU 60

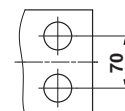

3

Part no.	Type	G [N] K<2	Mdd [Nm/°]	A	B	C	□D	E	F	H	J	K	L	M	øN	O	Weight [kg]
07 011 001	AU 15	100	0.44	50	4	29	20	28	17	50	70	25	40	M10	7	33	0.2
07 021 001	AU 15L	100	0.44	50	4	29	20	28	17	50	70	25	40	M10-LH	7	33	0.2
07 131 111	AUI 15	100	0.44	50	4	29	20	28	17	50	70	25	40	M10	7	33	0.4
07 141 111	AUI 15L	100	0.44	50	4	29	20	28	17	50	70	25	40	M10-LH	7	33	0.4
07 011 002	AU 18	200	1.32	62	5	31.5	22	34	20	60	85	35	45	M12	9	39	0.3
07 021 002	AU 18L	200	1.32	62	5	31.5	22	34	20	60	85	35	45	M12-LH	9	39	0.3
07 131 112	AUI 18	200	1.32	62	5	31.5	22	34	20	60	85	35	45	M12	9	39	0.5
07 141 112	AUI 18L	200	1.32	62	5	31.5	22	34	20	60	85	35	45	M12-LH	9	39	0.5
07 011 003	AU 27	400	2.6	73	5	40.5	28	40	27	80	110	45	60	M16	11.5	54	0.6
07 021 003	AU 27L	400	2.6	73	5	40.5	28	40	27	80	110	45	60	M16-LH	11.5	54	0.6
07 131 113	AUI 27	400	2.6	73	5	40.5	28	40	27	80	110	45	60	M16	11	54	1.2
07 141 113	AUI 27L	400	2.6	73	5	40.5	28	40	27	80	110	45	60	M16-LH	11	54	1.2
07 011 004	AU 38	800	6.7	95	6	53	42	52	37	100	140	60	80	M20	14	74	1.5
07 021 004	AU 38L	800	6.7	95	6	53	42	52	37	100	140	60	80	M20-LH	14	74	1.5
07 011 005	AU 45	1600	11.6	120	8	67	48	66	44	130	180	70	100	M24	18	89	2.7
07 021 005	AU 45L	1600	11.6	120	8	67	48	66	44	130	180	70	100	M24-LH	18	89	2.7
07 011 006	AU 50	2500	20.4	145	10	69.5	60	80	47	140	190	80	105	M36	18	93	6.3
07 021 006	AU 50L	2500	20.4	145	10	69.5	60	80	47	140	190	80	105	M36-LH	18	93	6.3
07 011 007	AU 60	5000	38.2	233	15	85	80	128	59	180	230	120	130	M42	18	116	15.6
07 021 007	AU 60L	5000	38.2	233	15	85	80	128	59	180	230	120	130	M42-LH	18	116	15.7

If no other units are specified, the numbers given are in mm.

G = max. load in N per element or rocker, by higher accelerations K, consult page 7.26.

Mdd = dynamic element torque in Nm/° by oscillation angles $\alpha \pm 5^\circ$ in speed range of $n_s = 300 - 600 \text{ min}^{-1}$.

AU: Inner part steel. Housing sizes 15–45 aluminium cast, sizes 50 and 60 nodular cast iron. Painted blue.

AUI: Stainless steel casting.

Oscillating Mountings

AS-P / AS-PV

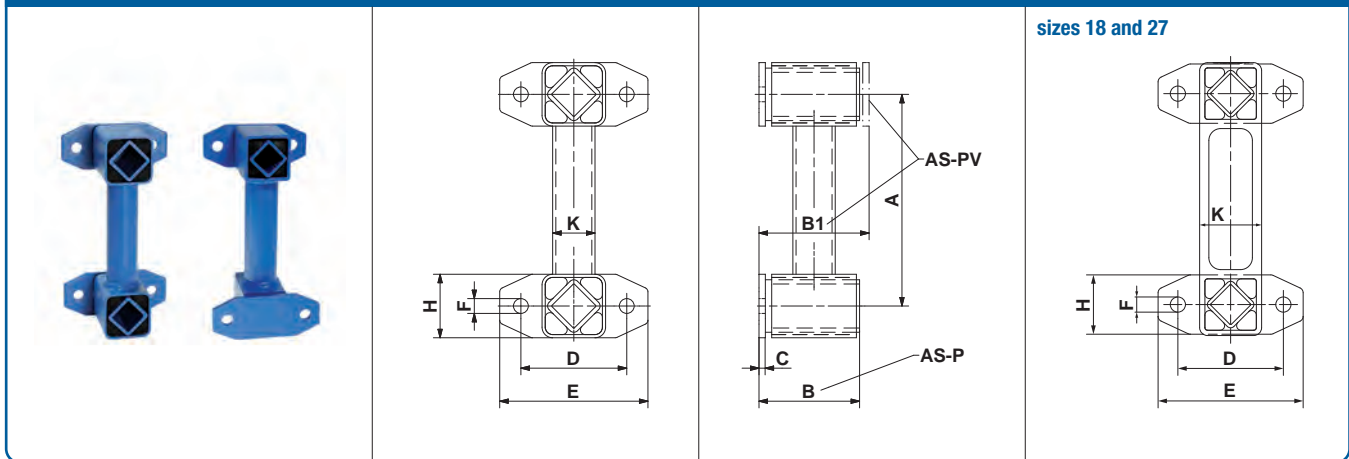

Part no.	Type	G [N] K<2	cd [N/mm]	A	B	B1	C	D	E	øF	H	K	Weight [kg]	Material structure		
														Aluminium profile	steel parts	paintd blue
07 081 001	AS-P 15	100	5	100	50	–	4	50	70	7	25	18	0.4		×	×
07 091 001	AS-PV 15	100	5	100	–	56	4	50	70	7	25	18	0.4		×	×
07 081 012	AS-P 18	200	11	120	62	–	5	60	85	9	35	34	0.6	×	×	×
07 091 012	AS-PV 18	200	11	120	–	68	5	60	85	9	35	34	0.6	×	×	×
07 081 013	AS-P 27	400	12	160	73	–	5	80	110	11.5	45	47	1.2	×	×	×
07 091 013	AS-PV 27	400	12	160	–	80	5	80	110	11.5	45	47	1.2	×	×	×
07 081 004	AS-P 38	800	19	200	95	–	6	100	140	14	60	40	2.8		×	×
07 091 004	AS-PV 38	800	19	200	–	104	6	100	140	14	60	40	3.6		×	×
07 081 005	AS-P 45	1600	33	200	120	–	8	130	180	18	70	45	4.7		×	×
07 091 005	AS-PV 45	1600	33	200	–	132	8	130	180	18	70	45	4.7		×	×
07 081 006	AS-P 50	2500	37	250	145	–	10	140	190	18	80	60	8.3		×	×
07 091 006	AS-PV 50	2500	37	250	–	160	10	140	190	18	80	60	8.3		×	×

If no other units are specified, the numbers given are in mm.

G = max. load in N per element or rocker, by higher accelerations K, consult page 7.26.

cd = dynamic spring value by oscillation angles $\alpha \pm 5^\circ$ in speed range of $n_s = 300 - 600 \text{ min}^{-1}$

AS-P for flange fixation.

AS-PV for flange fixation with inverted flange.

Oscillating Mountings

AS-C

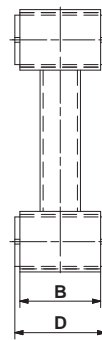
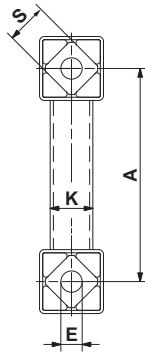

sizes 18 and 27

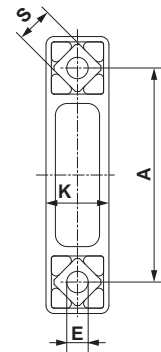

3

Part no.	Type	G [N] K<2	cd [N/mm]	A	B	D	øE	K	□S	Weight [kg]	Material structure		
											Aluminium profile	steel parts	painted blue
07 071 001	AS-C 15	100	5	100	40	45 ⁰ _{-0.3}	10 ^{+0.4} _{-0.2}	18	15	0.3	×	×	×
07 071 012	AS-C 18	200	11	120	50	55 ⁰ _{-0.3}	13 ⁰ _{-0.2}	34	18	0.3	×		×
07 071 013	AS-C 27	400	12	160	60	65 ⁰ _{-0.3}	16 ^{+0.5} _{-0.3}	47	27	0.8	×		×
07 071 004	AS-C 38	800	19	200	80	90 ⁰ _{-0.3}	20 ^{+0.5} _{-0.2}	40	38	1.9	×	×	×
07 071 005	AS-C 45	1600	33	200	100	110 ⁰ _{-0.3}	24 ^{+0.5} _{-0.2}	45	45	2.9	×	×	×
07 071 006	AS-C 50	2500	37	250	120	130 ⁰ _{-0.3}	30 ^{+0.5} _{-0.2}	60	50	6.1	×	×	×

If no other units are specified, the numbers given are in mm.

G = max. load in N per element or rocker, by higher accelerations K, consult page 7.26.

cd = dynamic spring value by oscillation angles $\alpha \pm 5^\circ$ in speed range of $n_s = 300 - 600 \text{ min}^{-1}$

AS-C for center connection.

Oscillating Mountings

AD-P / AD-PV

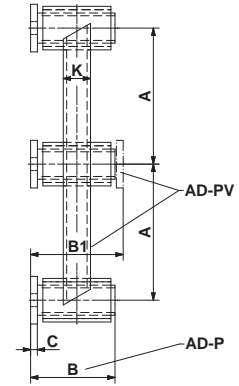
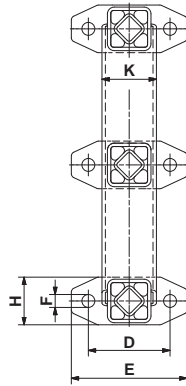

Part no.	Type	G [N]		cd [N/mm]	A	B	B1	C	D	E	øF	H	K	Weight [kg]	Material structure
		K=2	K=3												
07 111 001	AD-P 18	150	120	23	100	62	–	5	60	85	9	35	40×20	1.2	Steel parts, painted blue. Inner parts analogous to type AU.
07 121 001	AD-PV 18	150	120	23	100	–	68	5	60	85	9	35	40×20	1.2	
07 111 002	AD-P 27	300	240	31	120	73	–	5	80	110	11.5	45	55×34	2.3	
07 121 002	AD-PV 27	300	240	31	120	–	80	5	80	110	11.5	45	55×34	2.3	
07 111 003	AD-P 38	600	500	45	160	95	–	6	100	140	14	60	70×50	5.0	
07 121 003	AD-PV 38	600	500	45	160	–	104	6	100	140	14	60	70×50	5.0	
07 111 004	AD-P 45	1200	1000	50	200	120	–	8	130	180	18	70	80×40	8.5	
07 121 004	AD-PV 45	1200	1000	50	200	–	132	8	130	180	18	70	80×40	8.2	
07 111 005	AD-P 50	1800	1500	56	250	145	–	10	140	190	18	80	90×50	12.7	
07 121 005	AD-PV 50	1800	1500	56	250	–	160	10	140	190	18	80	90×50	12.7	

If no other units are specified, the numbers given are in mm.

G = max. load in N per element or rocker, by higher accelerations K, consult page 7.26.

cd = dynamic spring value by oscillation angles $\alpha \pm 5^\circ$ in speed range of $n_s = 300 - 600 \text{ min}^{-1}$

AD-P for flange fixation.

AD-PV for flange fixation with inverted flange.

Oscillating Mountings

AD-C

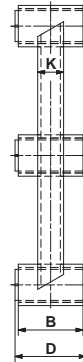
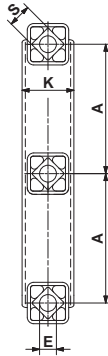

3

Part no.	Type	G [N]		cd [N/mm]	A	B	D	øE	K	□S	Weight [kg]	Material structure
		K=2	K=3									
07 101 001	AD-C 18	150	120	23	100	50	55 ⁰ _{-0.3}	13 ⁰ _{-0.2}	40 × 20	18	0.8	Steel welded construction, aluminium profile, painted blue.
07 101 002	AD-C 27	300	240	31	120	60	65 ⁰ _{-0.3}	16 ^{+0.5} _{-0.3}	55 × 34	27	1.6	
07 101 003	AD-C 38	600	500	45	160	80	90 ⁰ _{-0.3}	20 ^{+0.5} _{-0.2}	70 × 50	38	3.7	
07 101 004	AD-C 45	1200	1000	50	200	100	110 ⁰ _{-0.3}	24 ^{+0.5} _{-0.2}	80 × 40	45	6.1	

If no other units are specified, the numbers given are in mm.

G = max. load in N per element or rocker, by higher accelerations K, consult page 7.26.

cd = dynamic spring value by oscillation angles $\alpha \pm 5^\circ$ in speed range of $n_s = 300 - 600 \text{ min}^{-1}$

AD-C for center connection.

Oscillating Mountings

AR

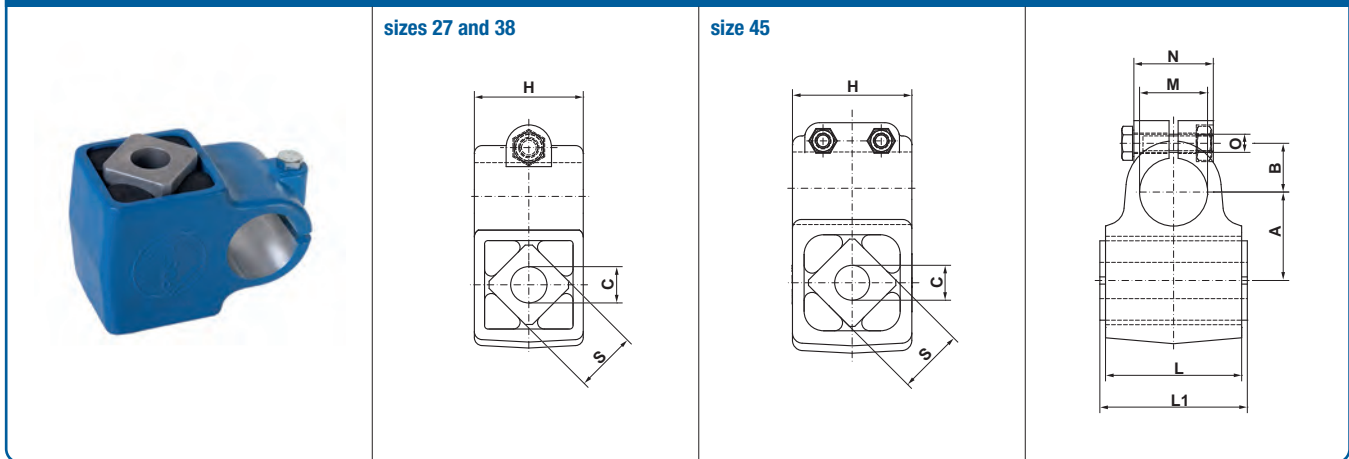

Part no.	Type	G [N] K<2	Mdd [Nm/°]	A	B	øC	H	L	L1	øM	N	O	□S	Weight [kg]	Material structure
07 291 003	AR 27	400	2.6	39 ±0.2	21.5	16 ^{+0.5} _{-0.3}	48	60	65 ⁰ _{-0.3}	30	35	M8	27	0.4	Aluminium profile, Aluminium cast, painted blue
07 291 004	AR 38	800	6.7	52 ±0.2	26.5	20 ^{+0.5} _{-0.2}	64	80	90 ⁰ _{-0.3}	40	50	M8	38	0.9	
07 291 005	AR 45	1600	11.6	65 ±0.2	32.5	24 ^{+0.5} _{-0.2}	82	100	110 ⁰ _{-0.3}	50	60	M10	45	2.0	

If no other units are specified, the numbers given are in mm.

G = max. load in N per element or rocker, by higher accelerations K, consult page 7.26.

Mdd = dynamic element torque in Nm/° by oscillation angles $\alpha \pm 5^\circ$ in speed range of $n_s = 300 - 600 \text{ min}^{-1}$.

For further information see chapter 7 Technology.

Oscillating Mountings

ST

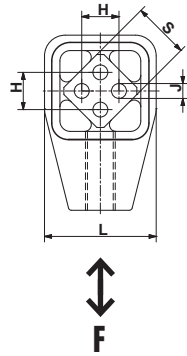

sizes 18 to 50

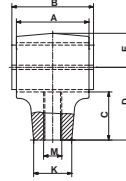

size 60

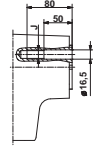

size 50-2

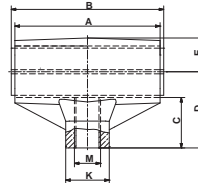

sizes 60-3 and 80

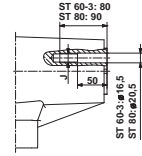

3

Part no.	Type	F max. [N]	n_s [min ⁻¹] max. $\alpha_{ST} \pm 5^\circ$	A	B	C	D	E	H	J	□K	L	M	□S	Weight [kg]
07 031 001	ST 18	400	600	50	55 ⁰ _{-0.3}	31.5	45	20	12 ±0.3	6 ^{+0.5} ₀	22	39	M12	18	0.2
07 041 001	ST 18L	400	600	50	55 ⁰ _{-0.3}	31.5	45	20	12 ±0.3	6 ^{+0.5} ₀	22	39	M12-LH	18	0.2
07 031 002	ST 27	1 000	560	60	65 ⁰ _{-0.3}	40.5	60	27	20 ±0.4	8 ^{+0.5} ₀	28	54	M16	27	0.4
07 041 002	ST 27L	1 000	560	60	65 ⁰ _{-0.3}	40.5	60	27	20 ±0.4	8 ^{+0.5} ₀	28	54	M16-LH	27	0.4
07 031 003	ST 38	2 000	530	80	90 ⁰ _{-0.3}	53	80	37	25 ±0.4	10 ^{+0.5} ₀	42	74	M20	38	1.1
07 041 003	ST 38L	2 000	530	80	90 ⁰ _{-0.3}	53	80	37	25 ±0.4	10 ^{+0.5} ₀	42	74	M20-LH	38	1.1
07 031 004	ST 45	3 500	500	100	110 ⁰ _{-0.3}	67	100	44	35 ±0.5	12 ^{+0.5} ₀	48	89	M24	45	1.8
07 041 004	ST 45L	3 500	500	100	110 ⁰ _{-0.3}	67	100	44	35 ±0.5	12 ^{+0.5} ₀	48	89	M24-LH	45	1.8
07 031 005	ST 50	6 000	470	120	130 ⁰ _{-0.3}	69.5	105	47	40 ±0.5	M12 × 40	60	93	M36	50	5.0
07 041 005	ST 50L	6 000	470	120	130 ⁰ _{-0.3}	69.5	105	47	40 ±0.5	M12 × 40	60	93	M36-LH	50	5.0
07 031 015	ST 50-2	10 000	470	200	210 ⁰ _{-0.3}	69.5	105	47	40 ±0.5	M12 × 40	60	93	M36	50	7.0
07 041 015	ST 50-2L	10 000	470	200	210 ⁰ _{-0.3}	69.5	105	47	40 ±0.5	M12 × 40	60	93	M36-LH	50	7.1
07 031 026	ST 60	13 000	440	200	210 ±0.2	85	130	59	45	M16	80	117	M42	60	15.6
07 041 026	ST 60L	13 000	440	200	210 ±0.2	85	130	59	45	M16	80	117	M42-LH	60	14.9
07 031 016	ST 60-3	20 000	440	300	310 ±0.2	85	130	59	45	M16	75	117	M42	60	20.0
07 041 016	ST 60-3L	20 000	440	300	310 ±0.2	85	130	59	45	M16	75	117	M42-LH	60	20.0
07 031 027	ST 80	27 000	380	300	310 ±0.2	100	160	77	60	M20	90	150	M52	80	34.0
07 041 027	ST 80L	27 000	380	300	310 ±0.2	100	160	77	60	M20	90	150	M52-LH	80	34.0

If no other units are specified, the numbers given are in mm.

F_{max} : Calculation of the acceleration force page 7.22.

n_s = max. revolutions by oscillation angle $\pm 5^\circ$; if osc. angle is below, higher rpm's are applicable, see «permissible frequencies» in chapter 7 Technology.

Sizes 18 to 45: Inner square Aluminium profile. Housing Aluminium cast. Housing painted blue.

Sizes 50 to 50-2: Inner square Aluminium profile. Housing nodular cast iron. Housing painted blue.

Sizes 60 to 80: Inner square steel. Housing nodular cast iron. Painted blue.

Oscillating Mountings

STI

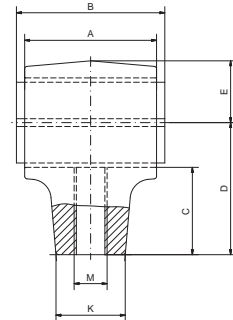
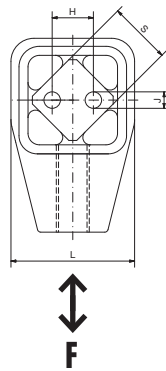

Part no.	Type	F max. [N]	n_s [min^{-1}] max. $\alpha_{ST} \pm 5^\circ$	A	B	C	D	E	H	J	□K	L	M	□S	Weight [kg]	Material structure
07 151 111	STI 18	400	600	50	$55_{-0.3}^0$	31.5	45	20	$12_{\pm 0.3}$	6	22	39	M12	18	0.5	Stainless steel casting and inner square solid material stainless
07 161 111	STI 18L	400	600	50	$55_{-0.3}^0$	31.5	45	20	$12_{\pm 0.3}$	6	22	39	M12-L	18	0.5	
07 151 112	STI 27	1 000	560	60	$65_{-0.3}^0$	40.5	60	27	$20_{\pm 0.4}$	8	28	54	M16	27	1.1	
07 161 112	STI 27L	1 000	560	60	$65_{-0.3}^0$	40.5	60	27	$20_{\pm 0.4}$	8	28	54	M16-L	27	1.1	

If no other units are specified, the numbers given are in mm.

F_{max} : Calculation of the acceleration force page 7.22.

n_s = max. revolutions by oscillation angle $\pm 5^\circ$; if osc. angle is below, higher rpm's are applicable, see «permissible frequencies» in chapter 7 Technology.

Oscillating Mountings

DO-A as a spring accumulator



size 45

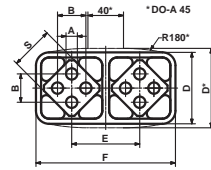

size 45

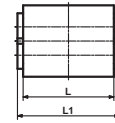

size 50

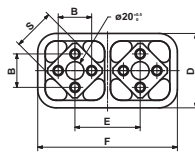

size 50

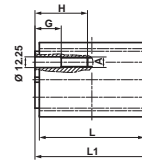

Part no.	Type	c_s [N/mm]	A	B	D	E	F	$\square S$	G	H	L	L1	Weight [kg]	Material structure
01 041 013	DO-A 45 × 80	100	$12^{+0.5}_0$	$35_{\pm 0.5}$	85	73	150	45	–	–	80	$90^{0}_{-0.3}$	1.9	Aluminium profiles, housings blue painted
01 041 014	DO-A 45 × 100	125	$12^{+0.5}_0$	$35_{\pm 0.5}$	85	73	150	45	–	–	100	$110^{0}_{-0.3}$	2.3	
01 041 026	DO-A 50 × 120	190	M12	$40_{\pm 0.5}$	89	78	167	50	30	60	120	$130^{0}_{-0.3}$	3.3	
01 041 029	DO-A 50 × 160	255	M12	$40_{\pm 0.5}$	89	78	167	50	30	60	160	$170^{0}_{-0.3}$	4.4	
01 041 027	DO-A 50 × 200	320	M12	$40_{\pm 0.5}$	89	78	167	50	40	70	200	$210^{0}_{-0.3}$	5.5	

If no other units are specified, the numbers given are in mm.

c_s = dynamic spring value of the complete accumulator by oscillating angle of $\pm 5^\circ$ and revolutions n_s between $300 - 600 \text{ min}^{-1}$.

1 spring accumulator is always consisting of 2 pcs. DO-A elements, for further information see chapter 7 Technology.

Material structure: DO-A 50 available with nodular cast iron housings on request.

Oscillating Mountings

AK

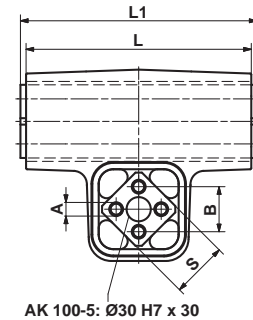
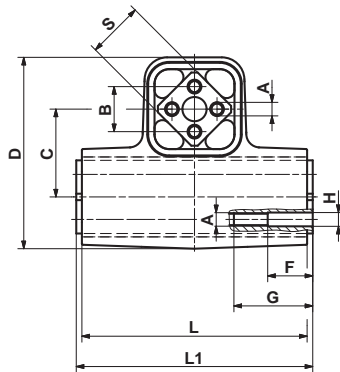

Part no.	Type	Max. load G [N] for the gyratory type:			A	B	C	D	F
		hanging	staying, crank driven	staying, free oscillating					
07 061 001	AK 15	160	128	80	5 ^{+0.5} ₀	10 ±0.2	27	54	–
07 061 002	AK 18	300	240	150	6 ^{+0.5} ₀	12 ±0.3	32	64	–
07 061 003	AK 27	800	640	400	8 ^{+0.5} ₀	20 ±0.4	45	97	–
07 061 004	AK 38	1600	1280	800	10 ^{+0.5} ₀	25 ±0.4	60	130	–
07 061 005	AK 45	3000	2400	1500	12 ^{+0.5} ₀	35 ±0.5	72	156	–
07 061 011	AK 50	5600	4480	2800	M12	40 ±0.5	78	172	40
07 061 012	AK 60	10000	8000	5000	M16	45	100	218	50
07 061 013	AK 80	20000	16000	10000	M20	60	136	283	50
07 061 009	AK 100-4	30000	24000	15000	M24	75	170	354	50
07 061 010	AK 100-5	40000	32000	20000	M24	75	170	340	50

Part no.	Type	G	øH	L	L1	□S	Weight [kg]	Material structure			Mounting inner square
								Inner square	Housing	Paint	
07 061 001	AK 15	–	–	60	65 ±0.2	15	0.3	Aluminium profile	steel welded construction	painted blue	End-to-end screw or threaded bar quality 8.8
07 061 002	AK 18	–	–	80	85 ±0.2	18	0.5				
07 061 003	AK 27	–	–	100	105 ±0.2	27	1.8				
07 061 004	AK 38	–	–	120	130 ±0.2	38	3.8				
07 061 005	AK 45	–	–	150	160 ±0.2	45	6.3				
07 061 011	AK 50	70	12.25	200	210 ±0.2	50	10.8	Steel	steel welded construction	Shoulder studs quality 8.8 for optimizing frictional connection	
07 061 012	AK 60	80	16.5	300	310 ±0.2	60	37.4				
07 061 013	AK 80	90	20.5	400	410 ±0.2	80	85.8				
07 061 009	AK 100-4	100	25	400	410 ±0.2	100	121.6				
07 061 010	AK 100-5	100	25	500	510 ±0.2	100	136.6				

If no other units are specified, the numbers given are in mm.

G = max. load in N per support column

Usual drive parameters from experience: Driving speed n_s up to approx. 380 min^{-1} , Oscillation angle α up to approx. $\pm 3.5^\circ$.

Limitation of application parameters see «permissible frequencies» in chapter 7 Technology.

For further information see chapter 7 Technology.

Oscillating Mountings

AV

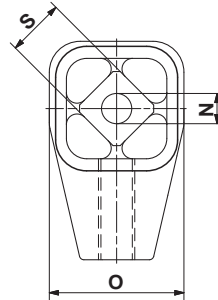
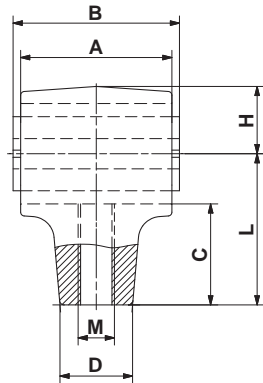

Inner square sizes 50 and 50L

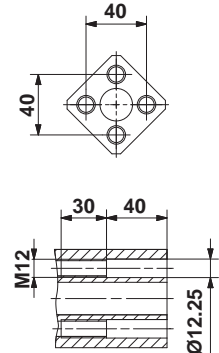

3

Part no.	Type	G [N] per suspension	A	B	C	□D	H	L	M
07 261 001	AV 18	600–1 600	60	65 ±0.2	40.5	28	27	60	M16
07 271 001	AV 18L	600–1 600	60	65 ±0.2	40.5	28	27	60	M16-LH
07 261 002	AV 27	1 300–3 000	80	90 ±0.2	53	42	37	80	M20
07 271 002	AV 27L	1 300–3 000	80	90 ±0.2	53	42	37	80	M20-LH
07 261 003	AV 38	2 600–5 000	100	110 ±0.2	67	48	44	100	M24
07 271 003	AV 38L	2 600–5 000	100	110 ±0.2	67	48	44	100	M24-LH
07 261 014	AV 40	4 500–7 500	120	130 ±0.2	69.5	60	47	105	M36
07 271 014	AV 40L	4 500–7 500	120	130 ±0.2	69.5	60	47	105	M36-LH
07 261 005	AV 50	6 000–16 000	200	210 ±0.2	85	80	59	130	M42
07 271 005	AV 50L	6 000–16 000	200	210 ±0.2	85	80	59	130	M42-LH

Part no.	Type	øN	O	□S	Weight [kg]	Material structure			Mounting inner square
						Inner square	Housing	Paint	
07 261 001	AV 18	13 ⁰ _{-0.2}	54	18	0.4	Aluminium profile	Aluminium cast	Housings blue painted	End-to-end screw or threaded bar quality 8.8.
07 271 001	AV 18L	13 ⁰ _{-0.2}	54	18	0.4				
07 261 002	AV 27	16 ^{+0.5} _{-0.3}	74	27	1.0				
07 271 002	AV 27L	16 ^{+0.5} _{-0.3}	74	27	1.0				
07 261 003	AV 38	20 ^{+0.5} _{-0.2}	89	38	1.7				
07 271 003	AV 38L	20 ^{+0.5} _{-0.2}	89	38	1.7				
07 261 014	AV 40	20 ^{+0.5} _{-0.2}	93	40	4.8		Nodular cast		M12 shoulder studs quality 8.8.
07 271 014	AV 40L	20 ^{+0.5} _{-0.2}	93	40	4.8				
07 261 005	AV 50	–	116	50	12.3				
07 271 005	AV 50L	–	116	50	12.3				

If no other units are specified, the numbers given are in mm.

G = max. load in N per suspension

Elements for higher load on request

Limitation of application parameters see «permissible frequencies» in chapter 7 Technology.

The threaded connection rod has to be provided by the customer.



VIBRATION DAMPERS

Highly elastic and tearproof mounts for passive and active vibration dampening

- Vibration-free mounting of motor test stands, emergency generators, compressors, etc.
- Tearproof mounting of suspended loads such as crane tracks and cable car cabins
- Anti-vibration machine leveling feet with balancing ball joints
- Impact-resistant vibration dampers for energy dissipation at belt transfer stations
- Standardised product range for high load capacities

Product advantages:



high degree
of isolation

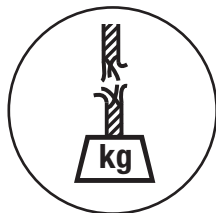









tearproof



maintenance-free

Selection table vibration dampers

	Illustration	Type	Description	Page
Vibration dampers basic types		ESL	Vibration dampers for the absorption of tensile, pressure and shear load. Also ideal for wall and ceiling installations. 8 element sizes from 200 N to 19 000 N. Natural frequency between 3.5–8 Hz. Mounts are mainly used for overcritical machine installations (machine frequency > mount frequency).	4.3
		AWI	Vibration dampers for to absorb tensile and pressure loads. 7 element sizes from 180 N to 16 000 N. Natural frequency between 3–7 Hz. Mounts are mainly used for overcritical machine installations (machine frequency > mount frequency).	4.4
		V	Vibration dampers for the absorption of tensile, pressure and shear load. Also ideal for wall and ceiling installations. 6 element sizes from 300 N to 12 000 N. Natural frequency between 10–30 Hz. Mounts can be used for subcritical machine installations (machine frequency < mount frequency).	4.5
Vibration dampers additional types		N	Mounting feet consisting of insulating plate, top cover with built-in levelling jack-screw with spherical joint for compensation of up to 10° of floor unevenness. Insulating plate oil- and acid-proof. FDA approved. 3 element sizes from 3 500 N to 20 000 N. Natural frequency between 19–27 Hz.	4.6
		NOX	Mounting feet consisting of insulating plate, stainless steel top cover with built-in stainless levelling jackscrew with spherical joint to compensate of up to 10° of floor unevenness. Insulating plate oil- and acid-proof. FDA approved. 2 element sizes from 5 000 N to 20 000 N. Natural frequency between 19–24 Hz.	
		Base plate P	Accessories for N and NOX for high shear forces or for assembling on a base or frame. The base plate must be bolted to the floor.	4.7
		M	Mounting feet consisting of metallic insulating cushion. Cushion resistant against corrosion, greases and solvents. 6 element sizes from 300 N to 35 000 N. Natural frequency between 14–26 Hz.	4.8
		NE	Adhesive cushioning plates made of closed-cell polyether urethane, no water absorption and good oil resistance. 3 element sizes from 500 N to 130 000 N. Natural frequency between 14–25 Hz.	4.9

Vibration damper

ESL

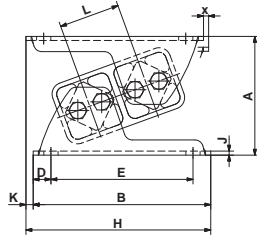

sizes 15 to 45

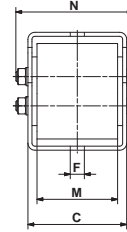

from size 50

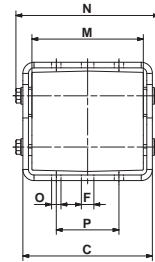

Part no.	Type	Load $G_{min.} - G_{max.}$ [N] on Z-axis	A unloaded	A* max. load	B	C	D	E	$\varnothing F$
05 021 001	ESL 15	200–550	54	43	85	49	10	65	7
05 021 002	ESL 18	450–1250	65	51	105	60	12.5	80	9.5
05 021 003	ESL 27	700–2000	88	68	140	71	15	110	11.5
05 021 004	ESL 38	1300–3800	117	91	175	98	17.5	140	14
05 021 005	ESL 45	2200–6000	143	110	220	120	25	170	18
05 021 016	ESL 50	4000–11000	170	138	235	142	25	185	18
05 021 017	ESL 50-1.6	5500–15000	170	138	235	186	25	185	18
05 021 018	ESL 50-2	7000–19000	170	138	235	226	25	185	18

Part no.	Type	H	J	K	L	M	N	O	P	x max.	Weight [kg]	Natural frequency $G_{min.} - G_{max.}$ [Hz]	Material structure
05 021 001	ESL 15	91	2	5.5	25.5	40	58.5	–	–	1.5	0.3	8.2–5.8	Aluminium profiles, steel brackets, painted blue, zinc-plated couplings
05 021 002	ESL 18	111	2.5	5.5	31	50	69	–	–	1.9	0.6	7.5–5.0	
05 021 003	ESL 27	148	3	8	44	60	85.3	–	–	2.7	1.3	6.2–4.5	
05 021 004	ESL 38	182	4	7	60	80	117	–	–	3.6	3.1	5.5–4.0	
05 021 005	ESL 45	235	5	15	73	100	138	–	–	4.4	5.9	5.0–3.5	
05 021 016	ESL 50	244	6	9	78	120	162	13.5	90	10	8.4	5.0–3.5	
05 021 017	ESL 50-1.6	244	8	9	78	160	206	13.5	90	10	10.4	5.0–3.5	
05 021 018	ESL 50-2	244	8	9	78	200	246	13.5	90	10	14.0	5.0–3.5	

* compression load $G_{max.}$ and cold flow compensation (after approx. 1 year).

If no other units are specified, the numbers given are in mm.

The sizes 50 to 50-2 can be combined with one another (identical heights and operation behaviour).

The max. load on X-axis should not exceed 200% of the Z-axis capacity.

The max. load on Y-axis should not exceed 20% of the Z-axis capacity.

Applicable on tensile, pressure and shear load.

Vibration damper

AWI

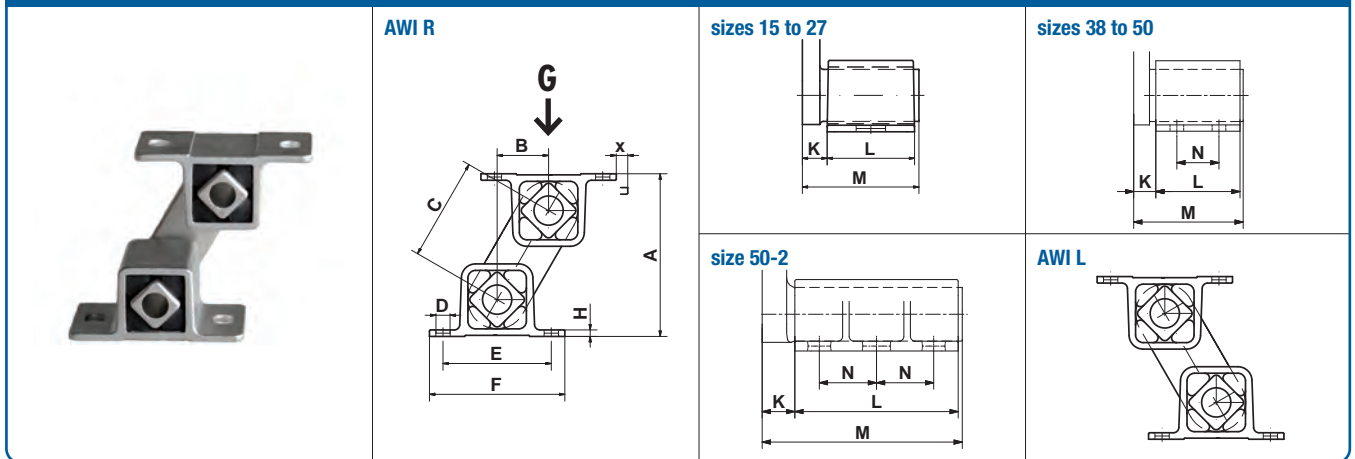

Part no.	Type	Load $G_{min.} - G_{max.}$ [N]	A unloaded	A* max. load	B	C	D	E	F
05 111 101	AWI 15R	180–400	68	55	22.5	45	7×10	50	65
05 121 101	AWI 15L	180–400	68	55	22.5	45	7×10	50	65
05 111 102	AWI 18R	350–850	88	70	30	60	9×15	60	80
05 121 102	AWI 18L	350–850	88	70	30	60	9×15	60	80
05 111 103	AWI 27R	650–1500	111	91	35	70	11×20	80	105
05 121 103	AWI 27L	650–1500	111	91	35	70	11×20	80	105
05 111 104	AWI 38R	1200–3000	150	122	47.5	95	13×20	100	125
05 121 104	AWI 38L	1200–3000	150	122	47.5	95	13×20	100	125
05 111 105	AWI 45R	2000–4800	177	145	55	110	13×26	115	145
05 121 105	AWI 45L	2000–4800	177	145	55	110	13×26	115	145
05 111 106	AWI 50R	4000–9600	194	159	60	120	17×27	130	170
05 121 106	AWI 50L	4000–9600	194	159	60	120	17×27	130	170
05 111 108	AWI 50-2R	6600–16000	194	159	60	120	17×27	130	170
05 121 108	AWI 50-2L	6600–16000	194	159	60	120	17×27	130	170

Part no.	Type	H	K	L	M	N	x max.	Weight [kg]	Natural frequency $G_{min.} - G_{max.}$ [Hz]	Material structure
05 111 101	AWI 15R	3	10	40	52	–	14	0.5	7.2–4.5	Stainless steel casting GX5CrNi19-10 (1.4308)
05 121 101	AWI 15L	3	10	40	52	–	14	0.5	7.2–4.5	
05 111 102	AWI 18R	3.5	14	50	67	–	19	0.9	6.5–3.7	
05 121 102	AWI 18L	3.5	14	50	67	–	19	0.9	6.5–3.7	
05 111 103	AWI 27R	4.5	17	60	80	–	22	1.9	6.0–3.7	
05 121 103	AWI 27L	4.5	17	60	80	–	22	1.9	6.0–3.7	
05 111 104	AWI 38R	6	21	80	104	40	31	4.5	5.2–3.2	
05 121 104	AWI 38L	6	21	80	104	40	31	4.5	5.2–3.2	
05 111 105	AWI 45R	8	28	100	132	58	35	7.8	5.0–2.8	
05 121 105	AWI 45L	8	28	100	132	58	35	7.8	5.0–2.8	
05 111 106	AWI 50R	12	40	120	165	60	38	12.8	4.8–2.8	
05 121 106	AWI 50L	12	40	120	165	60	38	12.8	4.8–2.8	
05 111 108	AWI 50-2R	12	45	200	250	70	38	20.3	4.8–2.8	
05 121 108	AWI 50-2L	12	45	200	250	70	38	20.3	4.8–2.8	

* compression load $G_{max.}$ and cold flow compensation (after approx. 1 year).

If no other units are specified, the numbers given are in mm.

The sizes 50 and 50-2 can be combined with one another (identical heights and operation behaviour).

Vibration damper

V

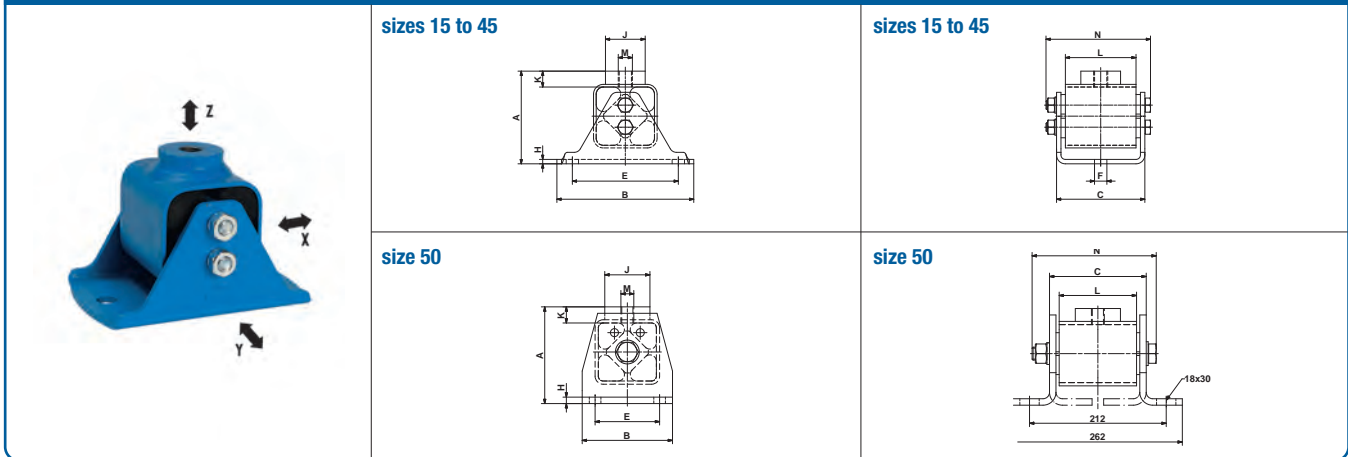

Part no.	Type	Load $G_{min.} - G_{max.}$ [N] on X- and Z-axis	A	B	C	E	$\varnothing F$	H	$\varnothing J$
05 011 001	V 15	300–800	49	80	51	55	9.5	3	20
05 011 002	V 18	600–1 600	66	100	62	75	9.5	3.5	30
05 011 003	V 27	1 300–3 000	84	130	73	100	11.5	4	40
05 011 024	V 38	2 600–5 000	105	155	100	120	14	5	45
05 011 005	V 45	4 500–8 000	127	190	122	140	18	6	60
05 011 006	V 50	6 000–12 000	150	140	150	100	–	10	70

Part no.	Type	K	L	M	N	Weight [kg]	Natural frequency $G_{min.} - G_{max.}$ [Hz]	Material structure
05 011 001	V 15	10	40	M10	59	0.3	30–23	Aluminium profile, welded steel housings, painted blue, zinc-plated couplings
05 011 002	V 18	13	50	M10	74	0.6	25–15	
05 011 003	V 27	14.5	60	M12	85	1.2	28–20	
05 011 024	V 38	17.5	80	M16	117	2.5	14–12	
05 011 005	V 45	22.5	100	M20	143	4.5	15–12	
05 011 006	V 50	25	120	M20	193	7.5	12–10	

If no other units are specified, the numbers given are in mm.
 The max. load on Y-axis should not exceed 20% of the X- resp. Z-axis capacity.
 Momentary shock loads of 2.5 g in X- and Z-axis admissible.
 Applicable on tensile, pressure and shear load.
 V 50: Alternativ mounting position 180° turned.

Vibration damper

N / NOX

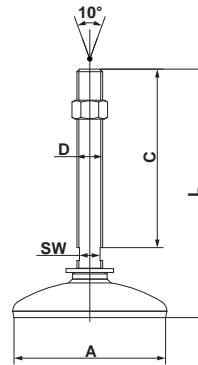

Part no.	Type	Load $G_{min.} - G_{max.}$ [N]	Natural frequency $G_{min.} - G_{max.}$ [Hz]	ϕA	C	D	L	SW	Weight [kg]	Material structure (rubber pad NBR with 50 ShA)
05 058 021	N 80 M12	3 500–8 000	27–22	80	60	M12	94	14	0.3	galvanised, base painted blue
05 058 022	N 80 M16	5 000–12 000	24–20	80	150	M16	188	13	0.5	galvanised, base painted blue
05 058 122	NOX 80 M16	5 000–12 000	24–20	80	150	M16	188	13	0.5	stainless steel 1.4301 and 1.4305
05 058 024	N 120 M20	8 000–20 000	22–19	120	150	M20	194	17	0.9	galvanised, base painted blue
05 058 124	NOX 120 M20	8 000–20 000	22–19	120	150	M20	194	17	0.9	stainless steel 1.4301 and 1.4305

If no other units are specified, the numbers given are in mm.
N/NOX are FDA approved.

Vibration damper

P

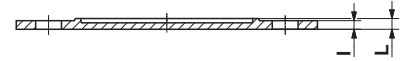
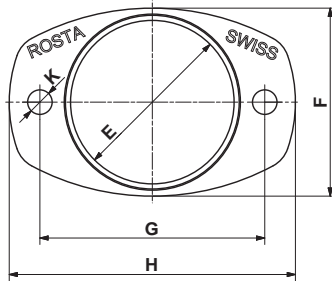

Part no.	Type	Accessory to	$\varnothing E$	F	G	H	I	$\varnothing K$	L	Weight [kg]	Material structure
05 060 101	P 80	N/NOX 80	80	92	110	140	4	12	5	0.1	Aluminium cast
05 060 102	P 120	N/NOX 120	120	135	170	210	5	16	7	0.3	

If no other units are specified, the numbers given are in mm.

Vibration damper

M

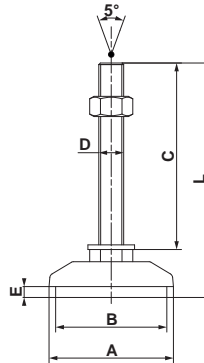

Part no.	Type	Load $G_{min.} - G_{max.}$ [N]	Max. dynamic load [N]	Deflection with $G_{max.}$ approx. [mm]	Natural frequency [Hz]	ϕA	ϕB	C	D	E	L	Weight [kg]
05 158 001	M 43 M16	300–2500	12500	3.0	20–26	80	61	120	M16	7	151	0.7
05 158 002	M 44 M16	2000–27000	70000	3.0	20–26	80	72	120	M16	7	151	0.7
05 158 003	M 45 M20	5000–35000	75000	3.0	20–26	128	119	120	M20	8	157	1.8
05 158 011	M 43W M16	300–2500	12500	6.0	14–19	80	63	120	M16	11	155	0.6
05 158 012	M 44W M16	1000–13000	45000	6.0	14–19	80	71	120	M16	18	162	0.7
05 158 013	M 45W M20	2000–25000	60000	6.0	14–19	128	120	120	M20	18	168	1.9

If no other units are specified, the numbers given are in mm.

Insulates structure-borne noise.

Chrome-steel cushion temperature resistant -40°C to $+250^{\circ}\text{C}$.

Resistant against corrosion, greases and solvents.

Up to 3 g dynamic shock loading permissible.

Unlimited lifetime.

On request available stainless steel anti-slip soles with granules on the underside:

– Part no. 04 020 451 for M 43 M16 and M 43W M16

– Part no. 04 020 452 for M 44 M16 and M 44W M16

– Part no. 04 020 453 for M 45 M20 and M 45W M20

Vibration damper

NE

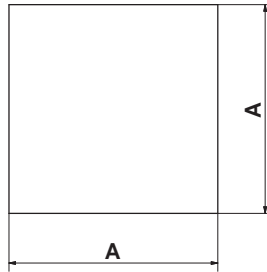

Part no.	Type	Load $G_{min.} - G_{max.}$ [N]	Deflection $G_{min.} - G_{max.}$ [mm]	Natural frequency $G_{min.} - G_{max.}$ [Hz]	A	B	Weight [kg]	Material structure
05 100 901	NE 50-12	500–1 500	0.5–1.4	25–14	50	12.5	0.02	– Polyether-Urethane closed-cell – No water absorption – Working temperature –30 to +70 °C – Good oil-resistance
05 100 902	NE 80-12	1 500–4 500	0.5–1.4	25–14	80	12.5	0.06	
05 100 903	NE 400-12	44 000–130 000	0.5–1.4	25–14	400	12.5	1.54	

If no other units are specified, the numbers given are in mm.

Tolerances according to ISO3302-1:1999 class L3 and EC3. The deflection of the cushions by the mentioned max. catalogue load capacities is 1.4 mm.



TENSIONER DEVICES

Optimum tension for chain and belt drives

- Quiet and smooth running
- Best possible transfer of power
- Automatic re-tensioning
- Compensation for belt elongation
- Pressing, guiding and vibration damping

Product advantages:

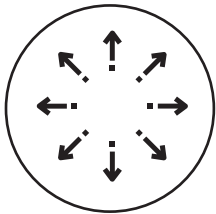

wide range
of applications

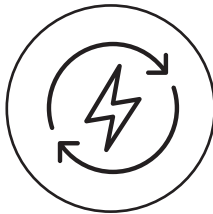

energy-saving

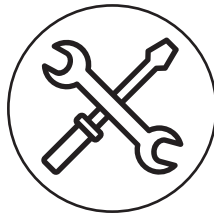

minimal
maintenance costs

Selection table tensioner devices

	Illustration	Type	Description	Page
Standard tensioner devices		SE	Standard component. Housing and inner part made out of steel. Rubber quality Rubmix 10. Steel parts ROSTA blue painted. Working temperature: – 40 ° to + 80 °C.	5.3
		SE-G	Oil resistant. Housing and inner part made out of steel. Rubber quality Rubmix 20. Steel parts galvanized. Marked with yellow dot or printing R20. Working temperature: – 30 ° to + 90 °C.	
		SE-W	Heat resistant. Housing and inner part made out of steel. Rubber quality Rubmix 40. Steel parts ROSTA blue painted. Marked with red dot or printing R40. Tension force 40% less than SE. Working temperature: – 35 ° to + 120 °C.	
Additional tensioner devices		SE-R	Reinforced lever arm. Housing and inner part made out of steel. Rubber quality Rubmix 10. Arm and inner core especially welded for use on combustion engines and compressors. Steel parts ROSTA blue painted. Marked with white ring or printing SE-R. Working temperature: – 40 ° to + 80 °C.	5.3
		SE-I	Housing and inner part made out of stainless steel. Rubber quality Rubmix 10. For the use in food- and pharmaceutical industries. Material: GX5CrNi19-10. Working temperature: – 40 ° to + 80 °C.	5.4
		SE-B	Boomerang®. Housing and inner part made out of steel. Rubber quality Rubmix 10. For the tensioning of very long chain and belt drives (triple compensation). Steel parts ROSTA blue painted. Working temperature: – 40 ° to + 80 °C.	5.5
		SE-F	Front mounting device. Housing and inner part made out of steel. Rubber quality Rubmix 10. As example for installations on blind-hole frames (fixation from the front only). Steel parts ROSTA blue painted. Hex socket screw quality 12.9. Working temperature: – 40 ° to + 80 °C.	5.6
		SE-FE	Front mounting. For installations on blind-hole frames (fixation from the front only). Steel parts painted black. Hex socket screw quality 12.9. Especially designed for engine applications. Working temperature: see page 5.7.	5.7

Note about accessories on pages 5.8–5.17.

Tensioner Device

SE/SE-G/SE-W/SE-R

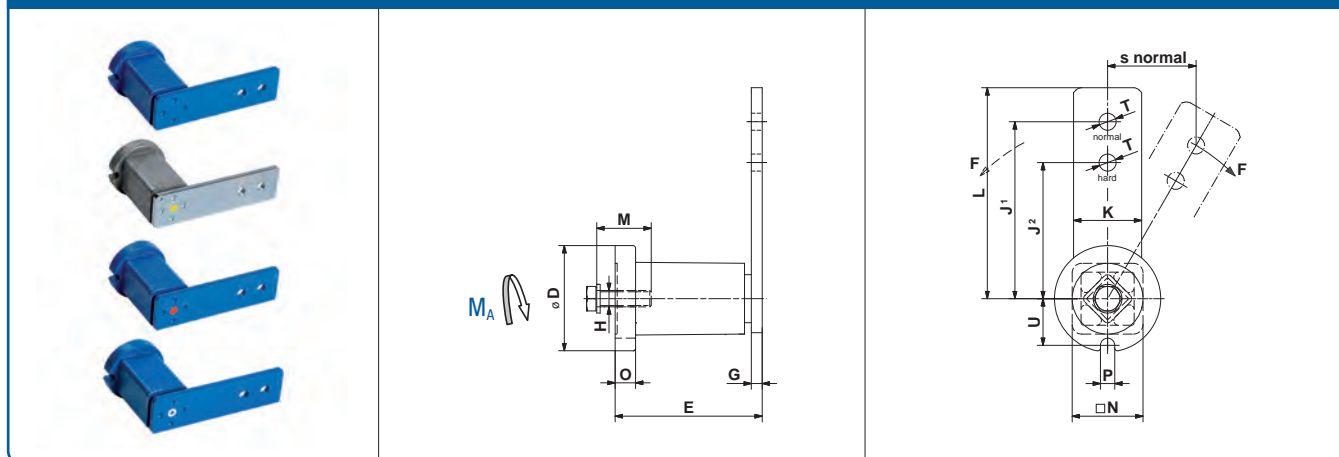

Part no.	Type	D	E	G	H	J ¹	J ²	K	L	M	N	O	P	T	U	Weight [kg]
06 011 001	SE 11	35	51 ⁺¹ _{-0.5}	5	M6	80	60	20	90	20	22	6	8	8.5	16.5	0.2
06 013 201	SE 11-G	35	51 ⁺¹ _{-0.5}	5	M6	80	60	20	90	20	22	6	8	8.5	16.5	0.2
06 011 002	SE 15	45	64 ⁺¹ _{-0.5}	5	M8	100	80	25	112.5	25	30	8	8.5	10.5	20.8	0.4
06 013 202	SE 15-G	45	64 ⁺¹ _{-0.5}	5	M8	100	80	25	112.5	25	30	8	8.5	10.5	20.8	0.4
06 015 002	SE 15-W	45	64 ⁺¹ _{-0.5}	5	M8	100	80	25	112.5	25	30	8	8.5	10.5	20.8	0.4
06 011 702	SE-R 15	45	64 ⁺¹ _{-0.5}	5	M8	100	80	25	112.5	25	30	8	8.5	10.5	20.8	0.4
06 011 003	SE 18	58	79 ⁺¹ _{-0.5}	7	M10	100	80	30	115	30	35	10.5	8.5	10.5	25.3	0.7
06 013 203	SE 18-G	58	79 ⁺¹ _{-0.5}	7	M10	100	80	30	115	30	35	10.5	8.5	10.5	25.3	0.7
06 015 003	SE 18-W	58	79 ⁺¹ _{-0.5}	7	M10	100	80	30	115	30	35	10.5	8.5	10.5	25.3	0.7
06 011 703	SE-R 18	58	79 ^{+1.5} _{-0.5}	7	M10	100	80	30	115	30	35	10.5	8.5	10.5	25.3	0.7
06 011 004	SE 27	78	108 ^{+1.5} _{-0.5}	8	M12	130	100	50	155	40	52	15	10.5	12.5	34.3	1.8
06 013 204	SE 27-G	78	108 ^{+1.5} _{-0.5}	8	M12	130	100	50	155	40	52	15	10.5	12.5	34.3	1.9
06 015 004	SE 27-W	78	108 ^{+1.5} _{-0.5}	8	M12	130	100	50	155	40	52	15	10.5	12.5	34.3	1.8
06 011 005	SE 38	95	140 ⁺² _{-0.5}	10	M16	175	140	60	205	40	66	15	12.5	20.5	42.0	3.3
06 013 205	SE 38-G	95	140 ⁺² _{-0.5}	10	M16	175	140	60	205	40	66	15	12.5	20.5	42.0	3.3
06 015 005	SE 38-W	95	140 ⁺² _{-0.5}	10	M16	175	140	60	205	40	66	15	12.5	20.5	42.0	3.3
06 011 006	SE 45	115	200 ⁺² ₋₁	12	M20	225	180	70	260	50	80	18	12.5	20.5	52.0	6.4
06 013 206	SE 45-G	115	200 ⁺² ₋₁	12	M20	225	180	70	260	50	80	18	12.5	20.5	52.0	6.5
06 015 006	SE 45-W	115	200 ⁺² ₋₁	12	M20	225	180	70	260	50	80	18	12.5	20.5	52.0	6.4
06 011 007	SE 50	130	210 ⁺³ ₋₁	20	M24	250	200	80	290	60	87	20	17	20.5	57.5	10.4
06 013 207	SE 50-G	130	210 ⁺³ ₋₁	20	M24	250	200	80	290	60	87	20	17	20.5	57.5	10.3
06 015 007	SE 50-W	130	210 ⁺³ ₋₁	20	M24	250	200	80	290	60	87	20	17	20.5	57.5	10.3

Further product and performance data in chapter 7 «Technology».

SE-R: Tensioning element with strengthened tensioning arm

If no other units are specified, the numbers given are in mm.

Tensioner Device

SE-I

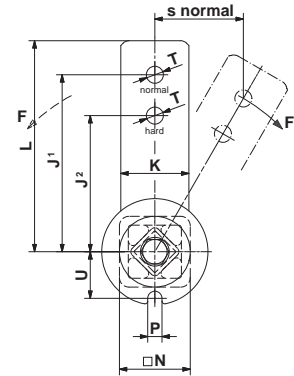
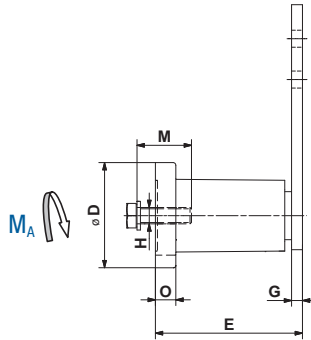

Part no.	Type	D	E	G	H	J ¹	J ²	K	L	M	N	O	P	T	U	Weight [kg]
06 071 111	SE-I 15	45	64 ⁺¹ _{-0.5}	5	M8	100	80	25	112.5	25	30	8	8.5	10.5	20.8	0.4
06 071 112	SE-I 18	58	79 ^{+1.5} _{-0.5}	7	M10	100	80	30	115	30	35	10.5	8.5	10.5	25.3	0.8
06 071 113	SE-I 27	78	108 ⁺² _{-0.5}	8	M12	130	100	50	155	40	52	15	10.5	12.5	34.3	2.3
06 071 114	SE-I 38	95	140 ⁺² _{-0.5}	10	M16	175	140	60	205	40	66	15	12.5	20.5	42.0	4.1

Further product and performance data in chapter 7 «Technology».

Tensioning element made out of stainless steel, INOX

If no other units are specified, the numbers given are in mm.

Tensioner Device

SE-B Boomerang®

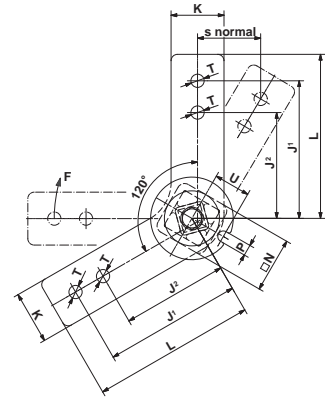
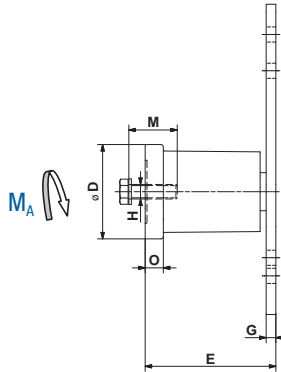

Part no.	Type	D	E	G	H	J ¹	J ²	K	L	M	N	O	P	T	U	Weight [kg]
06 021 003	SE-B 18	58	78 ^{+1.5} _{-0.5}	6	M10	100	80	30	115	30	35	10.5	8.5	10.5	25.3	0.8
06 021 004	SE-B 27	78	108 ⁺² _{-0.5}	8	M12	130	100	50	155	40	52	15	10.5	12.5	34.3	2.2

Further product and performance data in chapter 7 «Technology».
If no other units are specified, the numbers given are in mm.

Tensioner Device

SE-F

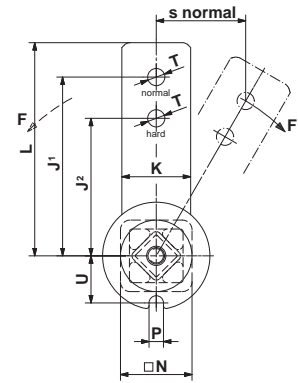
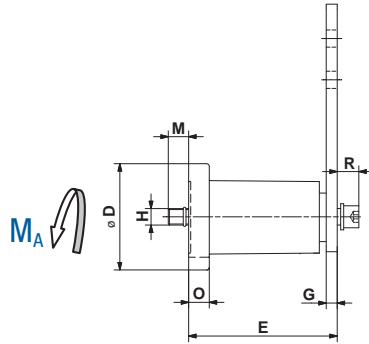

Part no.	Type	D	E	G	H	J ¹	J ²	K	L	M	N	O	P	R	T	U	Weight [kg]
06 061 002	SE-F 15	45	64 ⁺¹ _{-0.5}	5	M6	100	80	25	112.5	12	30	8	8.5	10	10.5	20.8	0.4
06 061 003	SE-F 18	58	79 ^{+1.5} _{-0.5}	7	M8	100	80	30	115	18	35	10.5	8.5	11	10.5	25.3	0.7
06 061 004	SE-F 27	78	108 ⁺² _{-0.5}	8	M10	130	100	50	155	17	52	15	10.5	15	12.5	34.3	1.9
06 061 005	SE-F 38	95	140 ⁺² _{-0.5}	10	M12	175	140	60	205	16	66	15	12.5	17	20.5	42.0	3.5
06 061 006	SE-F 45	115	200 ⁺³ ₋₁	12	M16	225	180	70	260	32	80	18	12.5	24	20.5	52.0	7.2
06 061 007	SE-F 50	130	210 ⁺³ ₋₁	20	M20	250	200	80	290	23	87	20	17	27	20.5	57.5	11.6

Further product and performance data in chapter 7 «Technology».

Tensioning element with front mounting.

Screw quality 12.9

If no other units are specified, the numbers given are in mm.

Tensioner Device

SE-FE

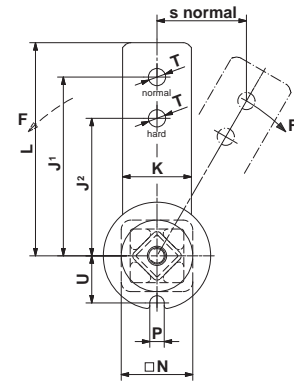
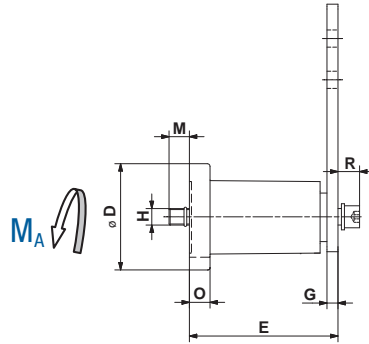

Part no.	Type	D	E	G	H	J ¹	J ²	K	L	M	N	O	P	R	T	U	Weight [kg]
06 093 904	SE-FE 27	78	110 ⁺² _{-0.5}	10	M10	130	100	50	155	16	52	15	10.5	15	12.5	34.3	2.1
06 095 905	SE-FE 38	95	120 ⁺² _{-0.5}	10	M12	145	110	60	175	35	66	15	12.5	17	22.0	42.0	3.1

Part no.	Type	Rubber Type	Working temperature	Marked with	Pre-tension $\leq 10^\circ$ (J ¹)		Pre-tension $\leq 20^\circ$ (J ¹)		Pre-tension $\leq 30^\circ$ (J ¹)		Coating
					F [N]	s [mm]	F [N]	s [mm]	F [N]	s [mm]	
06 093 904	SE-FE 27	Rubmix 20	- 30° to + 90°C	yellow dot or R20	150	23	380	44	810	65	RAL 9005 (black)
06 095 905	SE-FE 38	Rubmix 40	- 35° to + 120°C	red dot or R40	170	25	425	50	870	73	RAL 9005 (black)

Further product and performance data in chapter 7 «Technology».

Tensioning element with front mounting in special design.

Screw quality 12.9

If no other units are specified, the numbers given are in mm.

Tensioner Device

Sprocket wheel set N

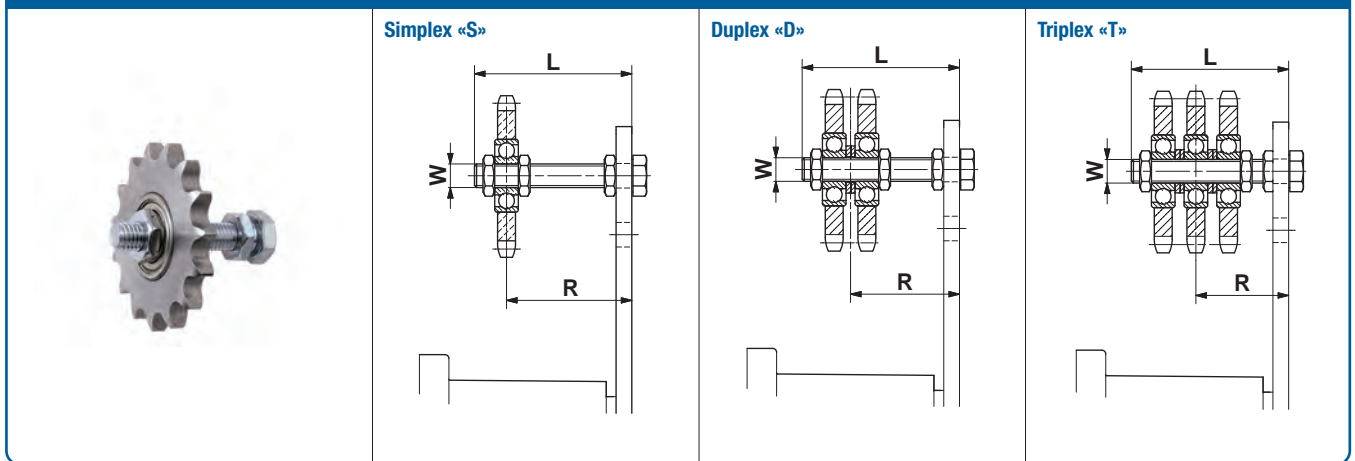

Part no.	Type	Roller chain		Number of teeth	W	L	Torque hex nut 0.5 d [Nm]	suitable for size SE	Adjusting range R with SE	Weight [kg]
		ANSI	DIN 8187							
Simplex «S»										
06 510 001	N $\frac{3}{8}$ " – 10 S	35	ISO 06 B-1	15	M10	55	20	15/18	22–43/23–43	0.15
06 510 002	N $\frac{1}{2}$ " – 10 S	40	ISO 08 B-1	15	M10	55	20	18	23–44	0.20
06 510 003	N $\frac{5}{8}$ " – 12 S	50	ISO 10 B-1	15	M12	80	35	27	27–65	0.35
06 510 004	N $\frac{3}{4}$ " – 12 S	60	ISO 12 B-1	15	M12	80	35	27	27–65	0.55
06 510 005	N $\frac{3}{4}$ " – 20 S	60	ISO 12 B-1	15	M20	100	165	38	40–80	0.85
06 510 006	N1" – 20 S	80	ISO 16 B-1	13	M20	100	165	38	40–80	1.25
06 510 007	N1 $\frac{1}{4}$ " – 20 S	100	ISO 20 B-1	13	M20	100	165	45/50	40–80/48–80	2.00
06 510 008	N1 $\frac{1}{2}$ " – 20 S	120	ISO 24 B-1	11	M20	140	165	45/50	40–120/48–120	2.35
Duplex «D»										
06 520 001	N $\frac{3}{8}$ " – 10 D	35	ISO 06 B-2	15	M10	55	20	15/18	27–39/28–39	2.00
06 520 002	N $\frac{1}{2}$ " – 10 D	40	ISO 08 B-2	15	M10	55	20	18	30–37	0.35
06 520 003	N $\frac{5}{8}$ " – 12 D	50	ISO 10 B-2	15	M12	80	35	27	36–57	0.60
06 520 004	N $\frac{3}{4}$ " – 12 D	60	ISO 12 B-2	15	M12	80	35	27	37–56	1.05
06 520 005	N $\frac{3}{4}$ " – 20 D	60	ISO 12 B-2	15	M20	120	165	38	50–90	1.35
06 520 006	N1" – 20 D	80	ISO 16 B-2	13	M20	120	165	38	55–84	2.10
06 520 007	N1 $\frac{1}{4}$ " – 20 D	100	ISO 20 B-2	13	M20	140	165	45/50	60–102/68–102	3.60
06 520 008	N1 $\frac{1}{2}$ " – 20 D	120	ISO 24 B-2	11	M20	140	165	45/50	65–97/73–97	4.25
Triplex «T»										
06 530 001	N $\frac{3}{8}$ " – 10 T	35	ISO 06 B-3	15	M10	70	20	18	33–48	0.25
06 530 002	N $\frac{1}{2}$ " – 12 T	40	ISO 08 B-3	15	M12	80	35	27	41–51	0.50
06 530 003	N $\frac{5}{8}$ " – 12 T	50	ISO 10 B-3	15	M12	80	35	27	43–50	0.95
06 530 004	N $\frac{5}{8}$ " – 20 T	50	ISO 10 B-3	15	M20	120	165	38	56–84	1.25
06 530 005	N $\frac{3}{4}$ " – 20 T	60	ISO 12 B-3	15	M20	120	165	38	59–80	1.50
06 530 006	N1" – 20 T	80	ISO 16 B-3	13	M20	160	165	45	74–108	2.90
06 530 007	N1 $\frac{1}{4}$ " – 20 T	100	ISO 20 B-3	13	M20	160	165	45/50	78–105/86–105	5.20
06 530 008	N1 $\frac{1}{2}$ " – 20 T	120	ISO 24 B-3	11	M20	180	165	45/50	90–111/98–111	6.20

Allows accurate positioning of relevant chain track.
 Ball-bearings 2Z/C3, permanently lubricated.
 Working temperature: –40° to +100 °C.
 If no other units are specified, the numbers given are in mm.

Tensioner Device

Sprocket wheel N

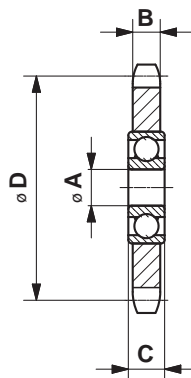

Part no.	Type	Roller chain		Number of teeth	A	B	C	D	Weight [kg]
		ANSI	DIN 8187						
06 500 001	N$\frac{3}{8}$"-10	35	ISO 06 B	15	10	5.3	9	45.81	0.06
06 500 002	N$\frac{1}{2}$"-10	40	ISO 08 B	15	10	7.2	9	61.08	0.15
06 500 003	N$\frac{1}{2}$"-12	40	ISO 08 B	15	12	7.2	12	61.08	0.15
06 500 004	N$\frac{5}{8}$"-12	50	ISO 10 B	15	12	9.1	12	76.36	0.27
06 500 005	N$\frac{5}{8}$"-20	50	ISO 10 B	15	20	9.1	15	76.36	0.29
06 500 006	N$\frac{3}{4}$"-12	60	ISO 12 B	15	12	11.1	12	91.63	0.47
06 500 007	N$\frac{3}{4}$"-20	60	ISO 12 B	15	20	11.1	15	91.63	0.47
06 500 008	N1"-20	80	ISO 16 B	13	20	16.1	15	106.14	0.88
06 500 009	N1$\frac{1}{4}$"-20	100	ISO 20 B	13	20	18.5	15	132.67	1.60
06 500 010	N1$\frac{1}{2}$"-20	120	ISO 24 B	11	20	24.1	15	135.23	1.93

Allows accurate positioning of relevant chain track.

Ball-bearings 2Z/C3, permanently lubricated.

Working temperature: -40° to $+100^{\circ}\text{C}$.

If no other units are specified, the numbers given are in mm.

Tensioner Device

Chain rider set P

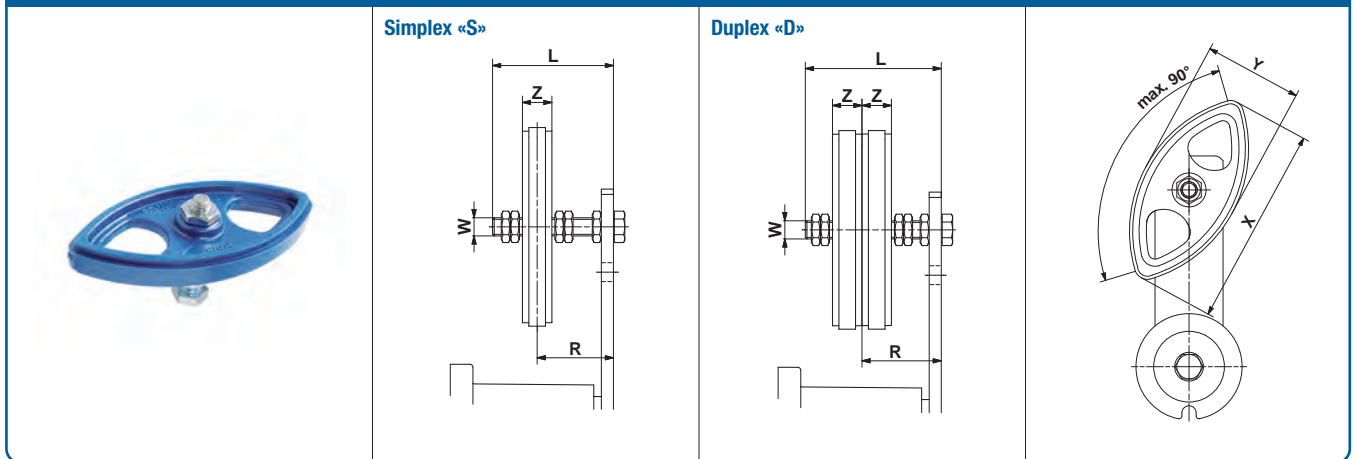

Part no.	Type	Roller chain		W	L	X	Y	Z	Torque hex nut 0.5 d [Nm]	suitable for size SE	Adjusting range R with SE	Weight [kg]
		ANSI	DIN 8187									
Simplex «S»												
06 550 001	P$\frac{3}{8}$"-8 S	35	ISO 06 B-1	M8	45	74	37	10.2	11	11	19-34	0.05
06 550 002	P$\frac{1}{2}$"-10 S	40	ISO 08 B-1	M10	55	96	48	13.9	20	15/18	23-41	0.10
06 550 003	P$\frac{5}{8}$"-10 S	50	ISO 10 B-1	M10	55	126	63	16.6	20	18	24-39	0.12
06 550 004	P$\frac{3}{4}$"-12 S	60	ISO 12 B-1	M12	80	148	72	19.5	35	27	30-61	0.18
Duplex «D»												
06 560 001	P$\frac{3}{8}$"-8 D	35	ISO 06 B-2	M8	45	74	37	10.2	11	11	25-30	0.07
06 560 002	P$\frac{1}{2}$"-10 D	40	ISO 08 B-2	M10	55	96	48	13.9	20	15/18	30-34	0.12
06 560 003	P$\frac{5}{8}$"-10 D	50	ISO 10 B-2	M10	70	126	63	16.6	20	18	34-46	0.17
06 560 004	P$\frac{3}{4}$"-12 D	60	ISO 12 B-2	M12	80	148	72	19.5	35	27	40-52	0.26

For double sided use. Max. allowed chain speed 1.5 m/sec.

Material: POM-H.

Working temperature: -40 ° to +100 °C.

If no other units are specified, the numbers given are in mm.

Tensioner Device

Chain rider P

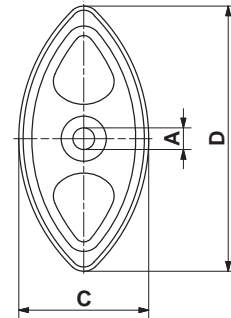

Part no.	Type	Roller chain		A	B	C	D	Weight [kg]
		ANSI	DIN 8187					
06 540 001	P $\frac{3}{4}$ "	35	ISO 06 B	8 $^{+0.2}_0$	10.2	37	74	0.02
06 540 002	P $\frac{1}{2}$ "	40	ISO 08 B	10 $^{+0.2}_0$	13.9	48	96	0.03
06 540 003	P $\frac{5}{8}$ "	50	ISO 10 B	10 $^{+0.2}_0$	16.6	63	126	0.05
06 540 004	P $\frac{3}{4}$ "	60	ISO 12 B	12 $^{+0.2}_0$	19.5	72	148	0.07

For double sided use. Max. allowed chain speed 1.5 m/sec.

Material: POM-H.

Working temperature: -40° to $+100^{\circ}\text{C}$.

If no other units are specified, the numbers given are in mm.

Tensioner Device

Tensioning roller standard R

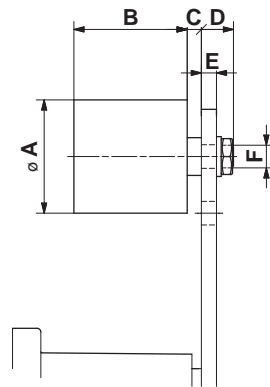

Part no.	Type	Max. speed [rpm]	Max. belt width	A	B	C	D	E	F	Torque hex nut 0.5 d [Nm]	suitable for size SE	Weight [kg]
06 580 001	R 11	8000	30	30	35	2	14	≤5	M8	25	11	0.08
06 580 002	R 15/18	8000	40	40	45	6	16	≤7	M10	20	15/18	0.17
06 580 003	R 27	6000	55	60	60	8	17	≤8	M12	35	27	0.40
06 580 004	R 38	5000	85	80	90	8	25	≤10	M20	165	38	1.15
06 580 005	R 45	4500	130	90	135	10	27	≤12	M20	165	45	1.75

Customer-specific $\varnothing A$ or outer contours on request.

Material: PA 6. Ball-bearings 2Z/C3, permanently lubricated.

Working temperature: -35° to $+100^{\circ}\text{C}$.

If no other units are specified, the numbers given are in mm.

Tensioner Device

Tensioning roller light RL

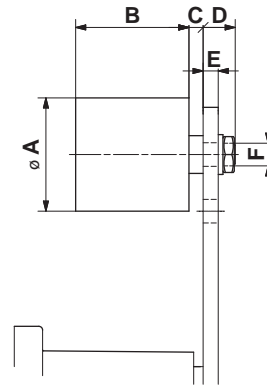

Part no.	Type	Max. speed [rpm]	Max. belt width	A	B	C	D	E	F	Torque hex nut 0.5 d [Nm]	suitable for size SE	Weight [kg]
06 580 901	RL 11	6 000	30	30	35	3	19	≤10	M8	25	11	0.08
06 580 902	RL 15/18	6 000	40	40	45	6	21	≤9	M10	49	15/18	0.17
06 580 903	RL 27	4 500	55	60	60	8	22	≤8	M12	86	27	0.50

Designed for light belt drive loads.

Material: PA 6. Ball-bearings 2Z / C3, permanently lubricated.

Working temperature: -35 ° to +80 °C.

If no other units are specified, the numbers given are in mm.

Tensioner Device

Bracket WS

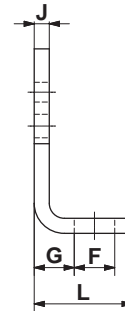
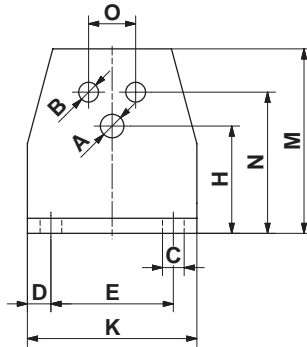

Part no.	Type	A	B	C	D	E	F	G	H	J	K	L	M	N	O	suitable for size SE	Weight [kg]
06 590 001	WS 11	6.5	5.5	7	7.5	30	13	11.5	27	4	45	30	46	35	10	11	0.08
06 590 002	WS 15	8.5	6.5	7	7.5	40	13	13.5	34	5	55	32	58	44	12	15	0.15
06 590 003	WS 18	10.5	8.5	9.5	10	50	15.5	16.5	43	6	70	38	74	55	20	18	0.28
06 590 004	WS 27	12.5	10.5	11.5	12.5	65	21.5	21	57	8	90	52	98	75	25	27	0.70
06 590 005	WS 38	16.5	12.5	14	15	80	24	21	66	8	110	55	116	85	35	38	0.90
06 590 006	WS 45	20.5	12.5	18	20	100	30	26	80	10	140	66	140	110	40	45	1.80

For the easy mounting of tensioners on the standard support (except SE 50).
If no other units are specified, the numbers given are in mm.

Tensioner Device

Safety Sockets

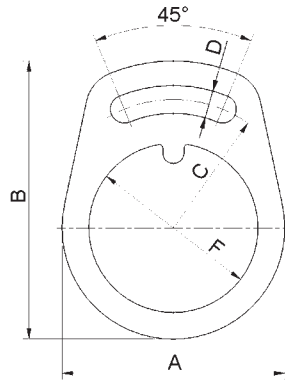

Part no.	Type	A	B	C	D	E	F	suitable for size SE	Weight [kg]
06 618 400	SS 27	104	130	60	13	8	79	27	0.35
06 618 394	SS 38	128	161	75	17	10	96.5	38	0.65

In case of uneven surfaces or coatings that give inadequate frictional locking, additional tensioning can be made with this safety clamp. If no other units are specified, the numbers given are in mm.

Tensioner Device

Tension bracket VS

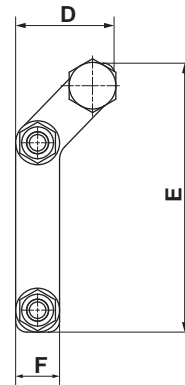
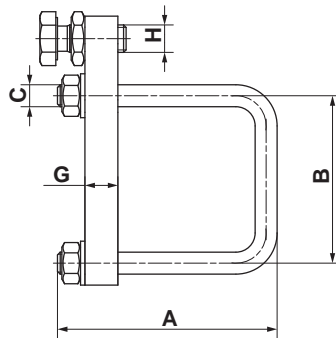

Part no.	Type	A	B	C	D	E	F	G	H	suitable for size SE	Weight [kg]
06 600 203	VS 15/18	54/59	36/42	M6	32	74	15	10	M8	15/18	0.16
06 600 204	VS 27	85	61	M8	36	98	16	12	M10	27	0.28
06 600 205	VS 38	112	79	M10	62	167	30	20	M10	38	1.00
06 600 206	VS 45	124	93	M10	97	205	50	20	M20	45	2.05
06 600 207	VS 50	139	102	M10	97	205	50	20	M20	50	2.15

The Tension bracket VS 15/18 is supplied with brackets fitting both SE 15 and SE 18 Tensioners.

The maximum pre-tensioning angle is 15°.

If no other units are specified, the numbers given are in mm.

Tensioner Device

Fast tension device SV

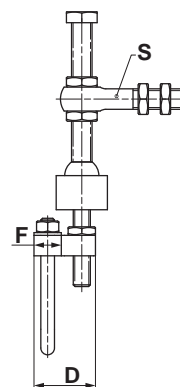
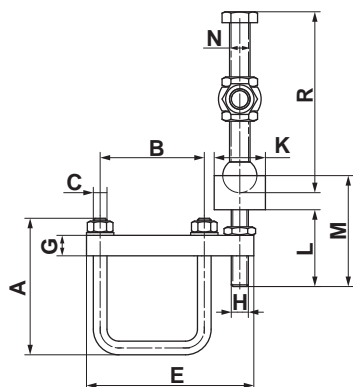

Part no.	Type	A	B	C	D	E	F	G	H	K
06 600 305	SV 15/18	54/59	36/42	M6	32	74	15	10	M8	24
06 600 301	SV 27	85	61	M8	36	98	16	12	M10	30
06 600 302	SV 38	112	79	M10	62	167	30	20	M10	30
06 600 303	SV 45	124	93	M10	97	205	50	20	M20	50
06 600 304	SV 50	139	102	M10	97	205	50	20	M20	50

Part no.	Type	L	M	N	R	S eyebolt	suitable for size SE	Weight [kg]
06 600 305	SV 15/18	22	39	M10 × 70	79	DIN4444 LAM 8 × 60	15/18	0.33
06 600 301	SV 27	45	60	M12 × 100	112	DIN4444 LAM 10 × 60	27	0.60
06 600 302	SV 38	45	60	M12 × 100	112	DIN4444 LAM 10 × 60	38	1.45
06 600 303	SV 45	60	86	M20 × 170	184	DIN4444 LAM 16 × 80	45	3.10
06 600 304	SV 50	60	86	M20 × 170	184	DIN4444 LAM 16 × 80	50	3.20

Installation guidelines SV in chapter 7 «Technology».
If no other units are specified, the numbers given are in mm.



MOTORBASES

Self-tensioning motor mounts for friction belt drives

- Prevent belt slippage
- One-time set-up
- Change belts without realignment
- Compensation for load changes
- Constant transfer of force

Product advantages:



cost-saving

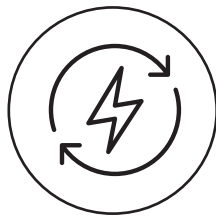

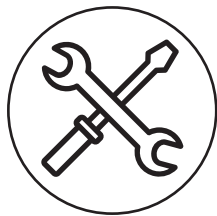

energy-saving

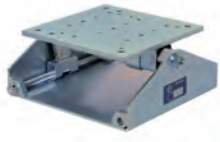

maintenance-free

Selection table motorbases

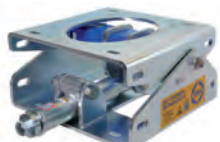
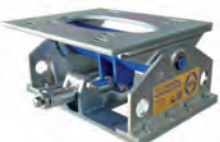
Illustration	Type	IEC			NEMA			Page
		Motor Frame Size	P [kW] 1000 min ⁻¹ 6-pole motor	P [kW] 1500 min ⁻¹ 4-pole motor	Motor Frame Size	P [HP] 1200 min ⁻¹ 6-pole motor	P [HP] 1800 min ⁻¹ 4-pole motor	
	MB 27 × 120	90S	0.75	1.1	143T	0.75	1	6.3
		90L	1.1	1.5	145T	1	1.5/2	
		100L	1.5	2.2/3	182T	1.5	3	
		112M	2.2	4	184T	2	5	
	MB 38 × 300	132S	3	5.5	213T	3	7.5	6.4
		132M	4/5.5	7.5	215T	5	10	
		160M	7.5	11	254T	7.5	15	
		160L	11	15	256T	10	20	
	MB 50 × 270-1	160M	7.5	11	254T	7.5	15	6.5
		160L	11	15	256T	10	20	
	MB 50 × 270-2	180M	–	18.5	284T	15	25	
		180L	15	22	286T	20	30	
	MB 50 × 400	200L	18.5/22	30	324T	25	40	
		–	–	–	326T	30	50	
	MB 50 × 500	225S	–	37	364T	40	60	
		225M	30	45	365T	50	75	
	MB 75 × 450	250M	37	55	404T	60	100	6.6
		–	–	–	405T	75	100/125	
	MB 75 × 550	280S	45	75	444T	100	125/150	
		280M	55	90	445T	125/150	150/200	
	MB 75 × 700	315S	75	110	447T	150–200	200–250	
		315M	90/110	132–160	–	–	–	
	MB 100 × 750	315M	90/110	132–160	447T	150–200	200–250	6.7
		315L	110–160	160–200	449T	200–300	250–300	
		355S	132–160	200–250	586/7	250–350	300–350	
		355M	200–250	250	–	–	–	
		355L	200–250	250	–	–	–	
	MB 100 × 1000	various	up to 275	up to 400	various	up to 370	up to 540	
MB 100 × 1500	various	up to 350	up to 550	various	up to 650	up to 750	on request	

- Attention: Don't use motorbase on floating chassis.
- Contact ROSTA for more frame sizes not listed.
- For the ATEX certified designs category 2 please change the 3rd digit of the part number to 3 (example: 02 200 201 = 02 300 201).
- ATEX label:



II 2G Ex h IIC T6 Gb
 II 2D Ex h IIC T85°C Db
 T_{amb}: -40°C ÷ +60°C

Motorbase

MB 27

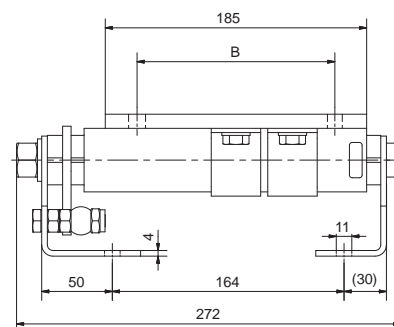
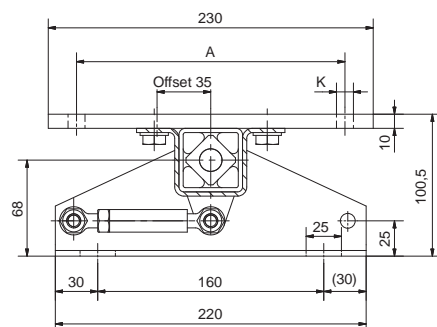

Part no.	Type	Motor Frame Size	IEC			Motor Frame Size	NEMA			Weight [kg]
			A	B	K		A	B	K	
02 200 201	MB 27 × 120	90S	140	100	10.5	143T	140	102	10.5	6.9
		90L	140	125	10.5	145T	140	127	10.5	6.9
		100L	160	140	10.5	182T	190	114	10.5	6.9
		112M	190	140	10.5	184T	190	140	10.5	6.9

Details ATEX on page 6.2.

If the tension range is not sufficient, the motor plate can be configured in the offset position.

The Motorbase has galvanized surfaces, the blue painted ROSTA rubber suspension element as well as several labels with information for adjustment procedures, product name and traceability. A QR code stands for getting additional product information.

If no other units are specified, the numbers given are in mm.

Please follow our instructions at www.rosta.com

Motorbase

MB 38

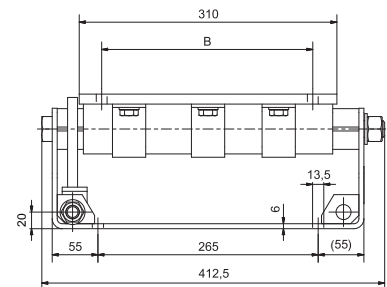
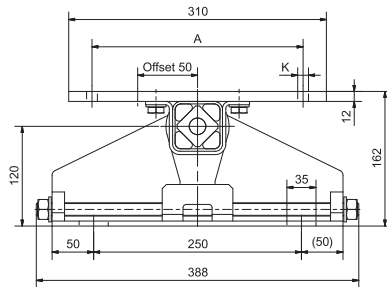
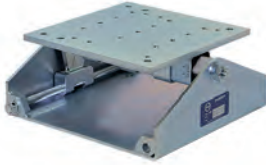

Part no.	Type	IEC				NEMA				Weight [kg]
		Motor Frame Size	A	B	K	Motor Frame Size	A	B	K	
02 000 301	MB 38 × 300	132S	216	140	M10	213T	216	140	M10	25.4
		132M	216	178	M10	215T	216	178	M10	25.4
		160M	254	210	13	254T	254	210	13	25.4
		160L	254	254	13	256T	254	254	13	25.4

Details ATEX on page 6.2.

If the tension range is not sufficient, the motor plate can be configured in the offset position.

If no other units are specified, the numbers given are in mm.

The Motorbase has galvanized surfaces, the ROSTA rubber suspension element as well as several labels with information for adjustment procedures, product name and traceability. A QR code stands for getting additional product information.

We recommend using the MB 50 for motor frame size 160 in vibrating screen applications.

Please follow our instructions at www.rosta.com

Motorbase

MB 50

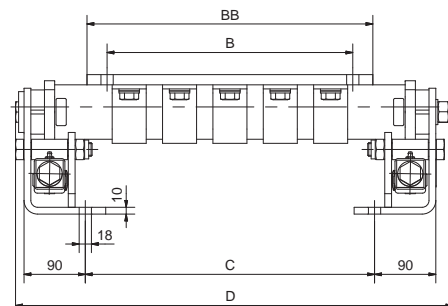
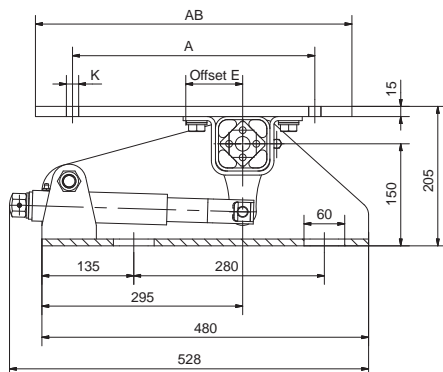

Part no.	Type	Motor Frame Size	IEC			NEMA			AB	BB	C	D	E	Weight [kg]	
			A	B	K	Motor Frame Size	A	B							K
02 200 526	MB 50 × 270-1	160M	254	210	14	254T	254	210	14	320	315	245	463	25	43.8
		160L	254	254	14	256T	254	254	14	320	315	245	463	25	43.8
02 200 527	MB 50 × 270-2	180M	279	241	14	284T	279	241	14	350	335	245	463	72	46.2
		180L	279	279	14	286T	279	279	14	350	335	245	463	72	46.2
02 200 528	MB 50 × 400	200L	318	305	18	324T	318	267	18	405	390	345	563	55	56.6
		–	–	–	–	326T	318	305	18	405	390	345	563	55	56.6
02 200 529	MB 50 × 500	225S	356	286	18	364T	356	286	18	465	420	425	643	72	63.2
		225M	356	311	18	365T	356	311	18	465	420	425	643	72	63.2

Details ATEX on page 6.2.

The ROSTA Motorbases MB 50 are supplied with the motor plate installed in «off-set» configuration. Depending on the operating angle of the running belts, the motor plate can also be configured «centrally» over the element axis. Corresponding threads are present on the motor plate. For a higher setting angle of the motor plate, the lever can be mounted at 45°.

The Motorbases have galvanized surfaces, the blue painted ROSTA rubber suspension element as well as several labels with information for adjustment procedures, product name and traceability. A QR code stands for getting additional product information.

If no other units are specified, the numbers given are in mm.

Please follow our instructions at www.rosta.com

Motorbase

MB 75

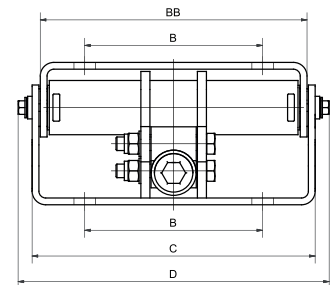
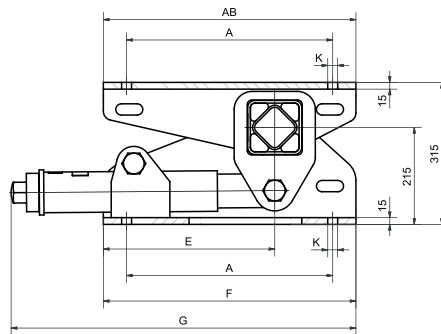
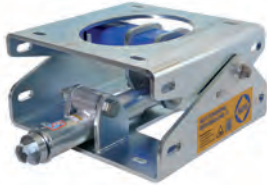

Part no.	Type	Motor Frame Size	IEC			NEMA			AB	BB	C	D	E	F	G	Weight [kg]	
			A	B	K	Motor Frame Size	A	B									K
02 202 701	MB 75 × 450	250M	406	349	22	404T	406	311	22	510	525	561	623	380	560	764	135
		–	–	–	–	405T	406	349	22	510	525	561	623	380	560	764	135
02 202 702	MB 75 × 550	280S	457	368	22	444T	457	368	22	560	590	626	688	380	560	764	150
		280M	457	419	22	445T	457	419	22	560	590	626	688	380	560	764	150
02 202 703	MB 75 × 700	315S	508	406	28	447T	457	508	22	630	740	776	838	400	600	805	190
		315M	508	457	28	–	–	–	–	630	740	776	838	400	600	805	190

Details ATEX on page 6.2.

The MB75 features a single, centred pre-tensioning device for easy handling (like the MB100). The hole pattern of the motor plate is equal to the pattern of the baseplate. This enables a previously fix installed motor onto a MB75 without extra efforts. Furthermore, the side plates of the MB75 incorporate extra openings for easier handling during installation.

All three sizes of the MB75 have a 100 mm offset position of the motor plate, a compact height of 315 mm, galvanized surfaces, the blue painted ROSTA rubber suspension element as well as several labels with information for adjustment procedures, product name and traceability. A QR code stands for getting additional product information.

If no other units are specified, the numbers given are in mm.

Please follow our instructions at www.rosta.com

Motorbase

MB 100

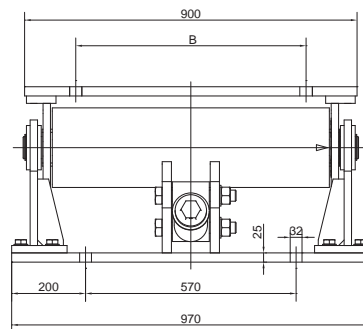
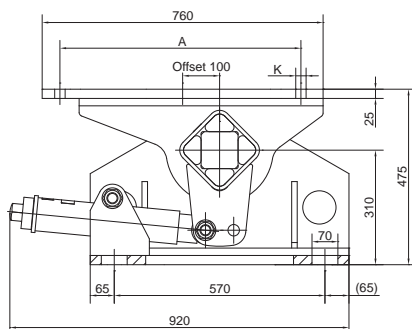
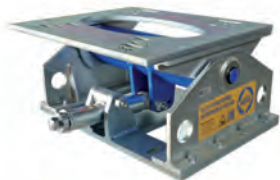

Part no.	Type	Motor Frame Size	IEC			Motor Frame Size	NEMA			Weight [kg]
			A	B	K		A	B	K	
02 200 900	MB 100 x 750	315M	508	457	28	447T	457	508	21	490
		315L	508	508	28	449T	457	635	21	490
		355S	610	500	28	586 / 7	584	560	30	490
		355M	610	560	28	–	–	–	–	490
		355L	610	630	28	–	–	–	–	490

Details ATEX on page 6.2.

For possibly required additional tensioning travel, the pretensioning device can be bolted into the front holes of the fork-head on the rubber suspension element.

The Motorbase has galvanized surfaces, the blue painted ROSTA rubber suspension element as well as several labels with information for adjustment procedures, product name and traceability. A QR code stands for getting additional product information.

If no other units are specified, the numbers given are in mm.

Please follow our instructions at www.rosta.com

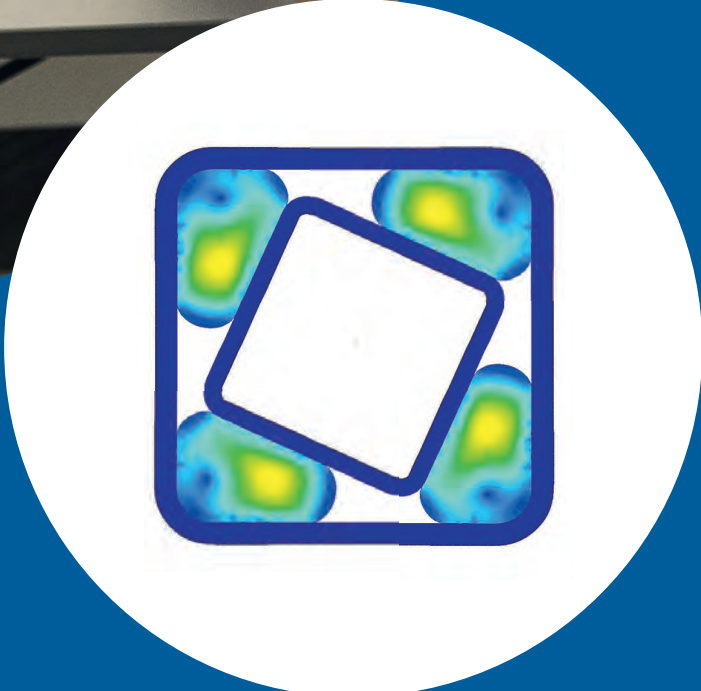
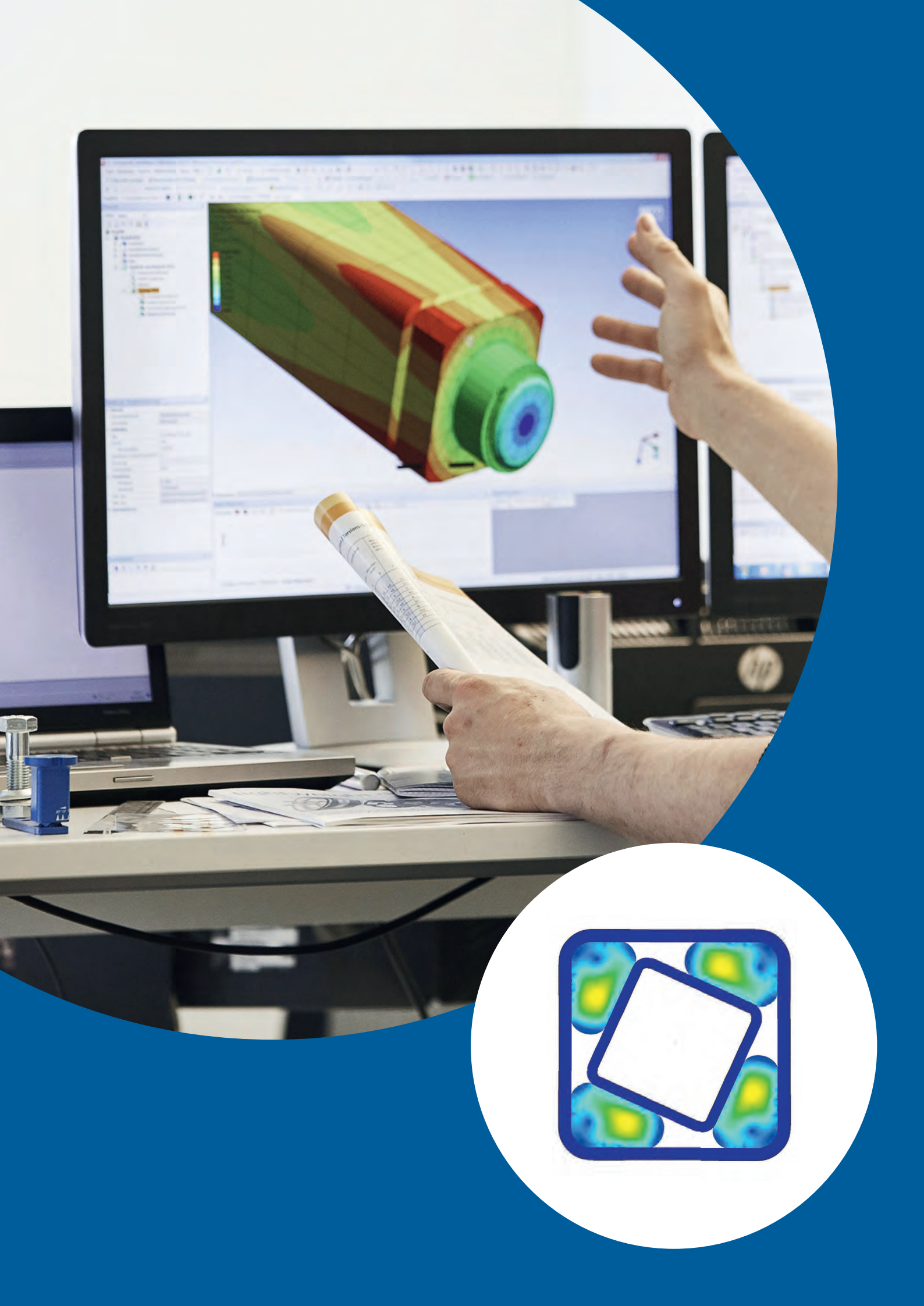

TECHNOLOGY

A unique spring system from experienced specialists

We at ROSTA have experienced the needs and solved the problems of our customers for more than 75 years. Together with our customers, we analyse their applications and concerns based on decades of experience. We help them to optimise their products and plants and improve their process safety. The result is higher productivity and a true competitive advantage.

Who doesn't want that?

TABLE OF CONTENTS

TECHNOLOGY

ROSTA BASICS

Page 7.4–7.8

RUBBER SUSPENSION ELEMENTS

Page 7.9–7.12

OSCILLATING MOUNTINGS

Page 7.13–7.30

VIBRATION DAMPERS

Page 7.31–7.38

TENSIONER DEVICES

Page 7.39–7.44

MOTORBASES

Page 7.45–7.48

PART NO. INDEX

Page 7.49–7.52

ROSTA Basics

Function

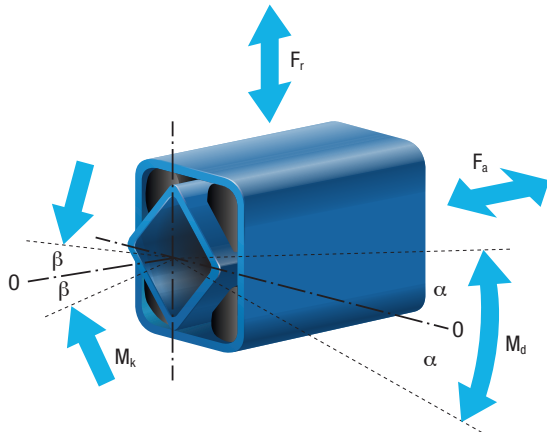

The ROSTA rubber suspension elements are mainly designed for applications as torsional spring devices offering operation angles of $\pm 30^\circ$. Depending on the particular function, not only torsional moments are generated by pivoting the spring device. According to the specific application additional radial F_r , axial F_a and / or cardanic M_k forces have usually to be taken in consideration. The occurring torques of the different elements and the additional load characteristics are indicated in the respective chapter.

Spring characteristic

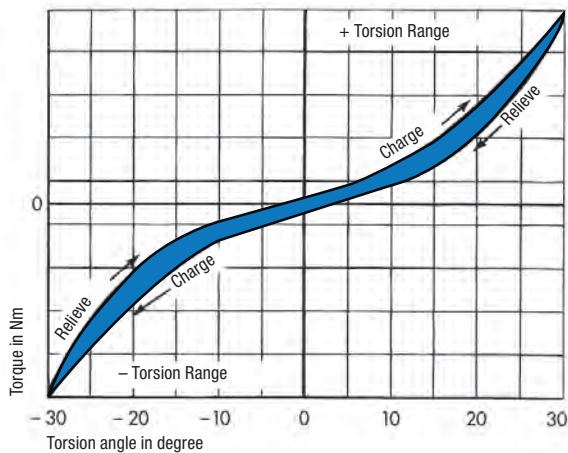

Due to the specific construction characteristics of the ROSTA rubber suspension element, pivoting the device \pm results in a slightly progressive spring characteristic. The torsion angle is limited to ± 30 for most elements.

ROSTA Basics

Damping

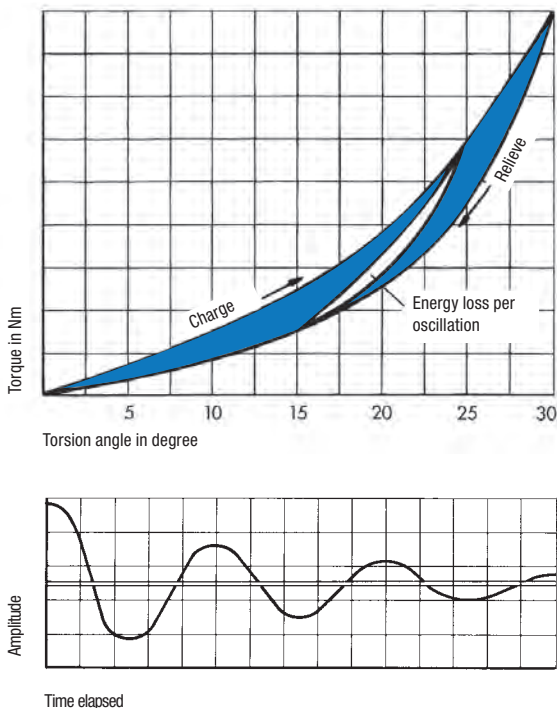

The occurring hysteresis in the ROSTA element is added to the resulting energy loss work in the rubber inserts during the pivoting activity of the spring device. In the process of the element actuation a part of the resulting energy is transformed into frictional work generating heat. The shaded surface between load and relieve headline indicates the effective energy loss. At element actuation out of the zero position up to 30°, the resulting average energy loss is at 15 to 20%. At the actuation of a pre-tensioned element, the resulting ± working angle is usually only a few degrees, therefore the energy loss reduces within a limit (see graph).

Uniquely animated element oscillations fade within short term, due to the occurring energy loss at each following post-pulse oscillation. (Very important at the use of ROSTA screen mountings – during the operation procedure of the screen the resulting power loss in the ROSTA mountings is neglectable; during the running down phase, close to the resonance frequency of the suspensions, an important amplitude exaggeration occurs. The high energy loss in the ROSTA screen mountings dampens and absorbs these exaggerations within only a few post-pulse oscillations.)

Natural frequency

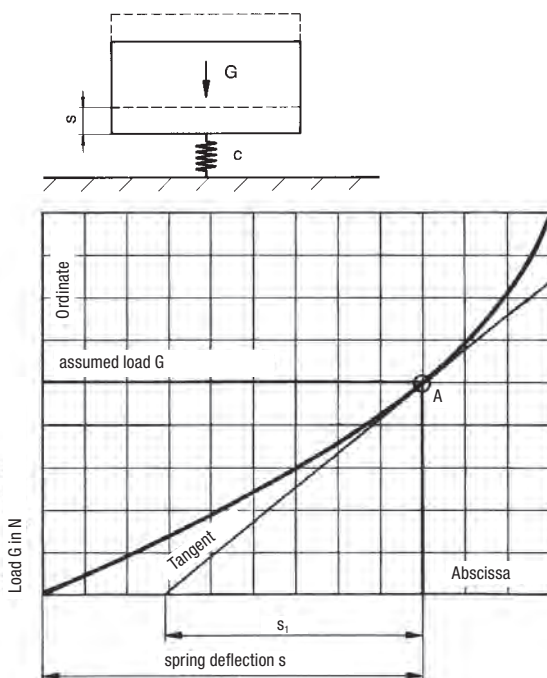

The determination of the natural frequency of a ROSTA suspension has to be carried out by spreading the tangent at the loading point «A» on the parabolic arc of the load deflection curve. The resulting distance s₁ on the axis of abscissa comes up to the arithmetical spring deflection in mm, required for the determination of the natural frequency.

$$\text{Natural frequency } n_e = \frac{300}{\sqrt{s_1 \text{ (in cm)}}} = \text{min}^{-1}$$

$$\text{or } f_e = \frac{5}{\sqrt{s_1 \text{ (in cm)}}} = \text{Hz}$$

Cold flow and settling of the rubber suspensions

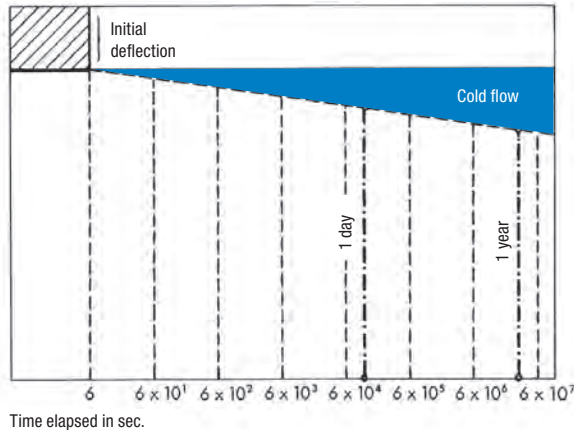

All elastic materials show more or less permanent measurable deformation over time when subjected to a load. This is noticeable in a relatively small additional deflection, the cold flow. This cold flow runs over a linear logarithmic time scale. The illustration shows that after being under a load for one day, already compensates for more than half of the flow deformation of a year; after one year of use, the overall element settling is largely compensated (depending on the temperature and frequency). Empirical findings show that the settling factor lies within a 3° to 5° loss of the element to the neutral 0° position, with combined vibrating bearings at approx. +10% of the respective nominal deflection according to the catalogue specification.

Temperature influence

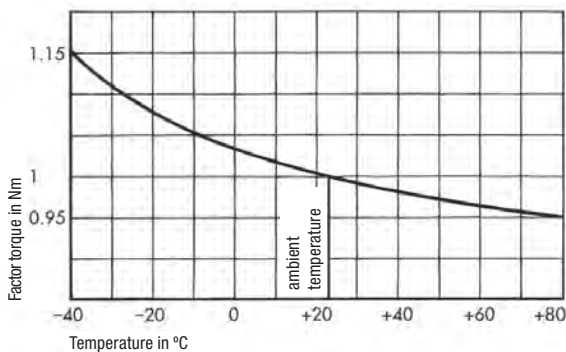

The ROSTA rubber suspension elements are designed in the standard rubber quality «Rubmix 10» for use in the temperature range of -40°C to $+80^{\circ}\text{C}$. As the temperature rises, the mechanical torque strength decreases. This decrease is at a low approx. 5% in the upper temperature range ($+80^{\circ}\text{C}$). At lower ambient temperatures, i.e. in the minus range, the mechanical torsional stiffness increases (at -40°C up to 15%). The internal damping of the elements undergoes a similar process: when the temperature drops, the damping percentage increases and then falls again when the temperature rises. Due to the internal friction (energy loss work), the rubber inserts in the suspension elements warm up with every movement, meaning the effective element temperature may vary in relation to the ambient temperature.

Service life

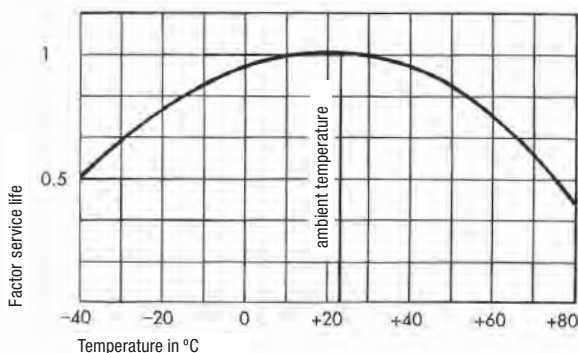

Provided the rubber suspension elements are selected according to the technical specifications, i.e. are operating within the given frequencies and oscillation angles and under the mentioned surrounding conditions, no loss of performance and functionality can be expected for many years. Extremely low or high permanent surrounding temperatures considerably shorten the lifetime expectancy of the rubber suspension elements. The opposite service life curve indicates the relevant life deduction at extreme \pm temperatures from factor 1 at room temperature of $+22^{\circ}\text{C}$.

ROSTA Basics

Quality control and tolerances

Since December 1992 ROSTA AG has been an ISO 9001 standard certified development, manufacture and distribution company. All products undergo regular functional and quality testing. The rubber inserts are continuously tested and controlled on the test machines of the in-house laboratory with regard to Shore A hardness, compression set, abrasive wear, rebound resilience, tensile strength, breaking elongation and aging behaviour. The dimensional tolerance of the rubber inserts is defined according DIN 7715 standard and the Shore A hardness according to DIN 53505 standard. The inner-core profiles and housings of the rubber suspension elements are subject to the tolerance guidelines of the relevant production process and respective supplier (e.g.

cast, extruded, edge rolled) and the individual material consistence (e.g. aluminium casting, steel tube, nodular cast iron part, etc.). The resulting torsional moments and spring deflections of the ROSTA rubber suspension elements are within a tolerance range of $\pm 15\%$ at the most, but usually lie in a much narrower range!



Permissible frequencies

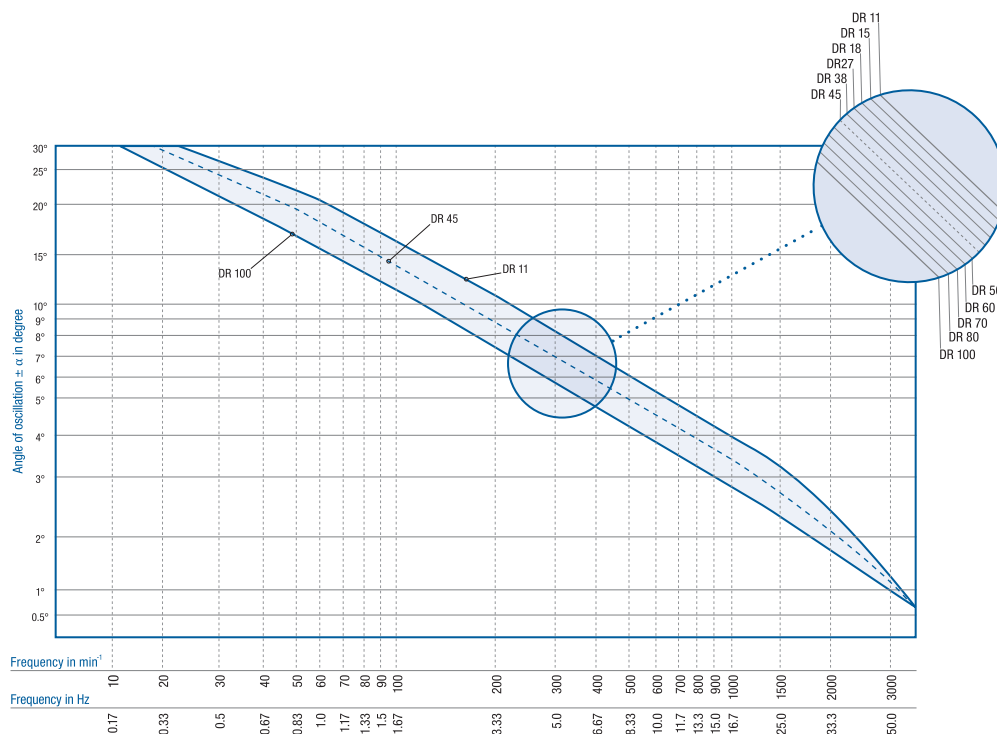

Alignment chart for determining the permissible frequencies and oscillation angles in relation to the respective rubber suspension element type (DR 11, 15, 18, etc.). The higher the frequency in min^{-1} , the lower the oscillation angle should be and vice versa.

Example: (see blue indication on chart) A rubber suspension of type DR 50 may be rotated from the neutral position (0°) to an oscillation angle of $\pm 6^\circ$ by a max. frequency of 340 min^{-1} . For applications of «pre-tensioned» elements working, e.g. under 15° of pre-tension and describing oscillation angles of $\pm 5^\circ$ at 250 min^{-1} , it is absolutely necessary to consult ROSTA.

ROSTA Basics

Rubber qualities

The majority of all ROSTA rubber suspension elements are equipped with the standard quality «Rubmix 10» rubber inserts. This rubber quality is based on a high content of natural rubber, offers good shape memory, low settling factors (cold flow), high mechanical strength and moderate aging behaviour (little embrittlement/hardening of the rubber inserts).

Where high oil consistency, heat resistance or even greater torques are required, other resilient inserts with the corresponding characteristics can be installed in the rubber suspension elements.

Special qualities on request.

Rubber quality	Factor in relation to the list «torque and loads» (chapter 2 rubber suspension elements)	Working temperature	Material	Comments
Rubmix 10	1.0	-40° to +80°C	NR	- Standard quality - Highest elasticity - Lowest cold flow
Rubmix 20	approx. 1.0	-30° to +90°C	CR	- Good oil-resistance - Elements marked with yellow dot or R20
Rubmix 40	approx. 0.6	-35° to +120°C	EPDM-Silicone	- High temperature resistance - Elements marked with red dot or R40
Rubmix 50	approx. 3.0	-35° to +90°C	PUR	- Max. oscillation angle ±20° - Limited oscillation frequencies - No permanent water contact - Elements marked with green dot or R50

Chemical resistance

The standardised ROSTA rubber suspension elements are equipped with «Rubmix 10» elastic inserts. These have a high chemical resistance compared to many media. For specific applications, however, the elements must be provided with additional protection or synthetically constructed elastomer inserts should be used («Rubmix 20», «Rubmix 40» or «Rubmix 50»), which will slightly change the characteristics compared to the standard quality (see Rubber qualities).

The resistance table below is only a guideline and is incomplete. In practical use, data for the concentration of the respective medium and the operating temperature are required to determine the resistance. Please contact us in this regard.

Rubmix	10	20	40	50
Acetone	+	00	++	00
Alcohol	++	++	++	0
Benzene	00	00	00	00
Caustic soda solution up to 25% (20°)	++	++	++	00
Citric acid	++	+	0	00
Diesel	00	+	00	+
Formic acid	+	+	0	00
Glycerine	+	+	++	00
Hydraulic fluid	0	+	00	00
Hydrochloric acid up to 15%	++	+	0	00
Javelle water	0	+	++	00
Lactic acid	++	++	++	+

Rubmix	10	20	40	50
Liquid ammonia	+	+	++	00
Lubricating grease and oil	00	+	00	+
Nitric acid up to 10%	00	+	+	00
Nitro thinner	00	00	00	00
Petrol (fuel)	00	0	00	++
Petroleum	00	+	00	++
Phosphoric acid up to 85%	00	00	00	00
Seawater	++	+	++	00
Sulphuric acid up to 10%	+	0	0	00
Tannic acid	++	+	++	00
Toluene	00	00	00	00
Treacle	++	++	++	0

++ excellent consistency, + good consistency, 0 sufficient consistency, 00 insufficient consistency

RUBBER SUSPENSION ELEMENTS



Rubber suspension elements

Description of inner squares



A
Suitable for alternating deflection via the element rest position. Nominal sizes 15 to 45: Fastening with 2 to 4 continuous screws (of which nominal sizes 27 to 45 with threads are available).

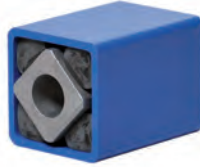

C
Attachment with central screw for frictional connection with 360° adjustment. For optimum frictional connection, please remove the paint on the front side. Alternating deflection up to max. $\pm 10^\circ$.

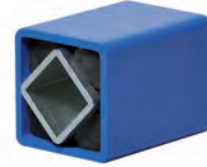

S
For plug-in connections, select plug-in length at least $2 \times$ light dimension «C». The inserted square must be blank, with a tolerance of h9 to h11. The corners may be over-rotating, the inner radius is max. 1.5 mm). Up to nominal size 18, a frictional connection can be made with one screw. No reciprocal deflection over the element zero position.

Serial and parallel connection

Serial connection

Double oscillating angle ($\pm 60^\circ$) with a constant torque.

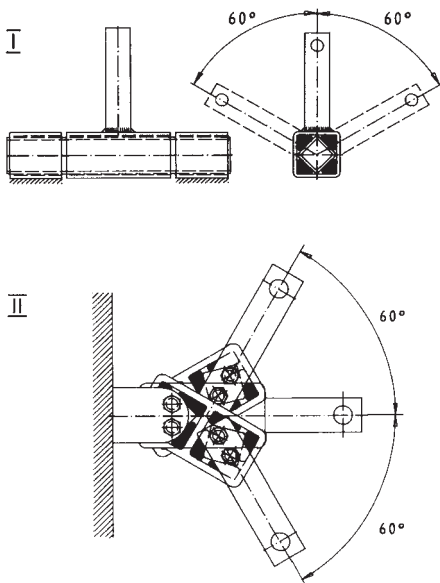

Parallel connection

Double torque at constant oscillating angle ($\pm 30^\circ$).

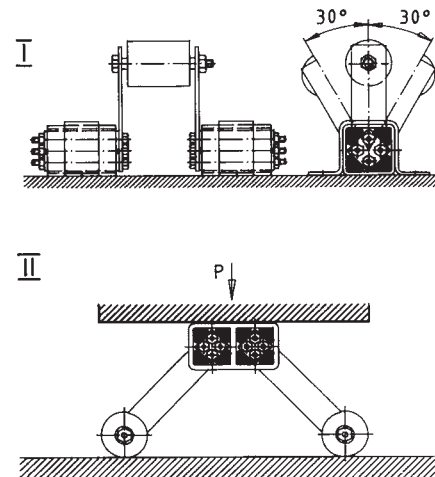

Rubber suspension elements

Examples of fixations

Housing

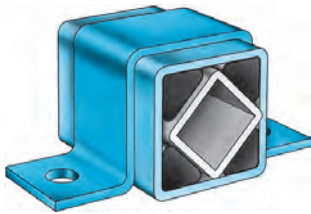

Outer tube with bracket BR

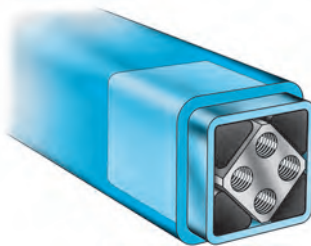

Plug-in connection

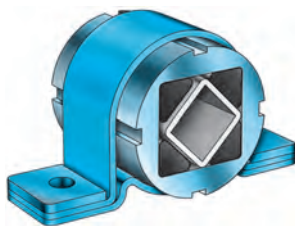

Round housing with bracket BK



Outer housing in clamping jaw

Inner Square Section

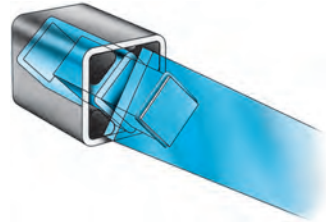

Plug-in connections: inner square made of tubular steel, lever arm with welded-on square profile

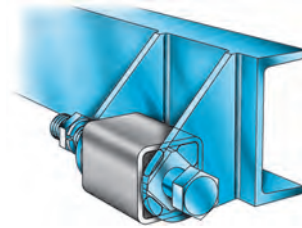

Inner square section with a central through bore

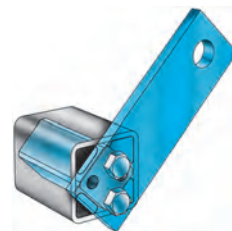

Inner square with through holes and bolted-on lever arm

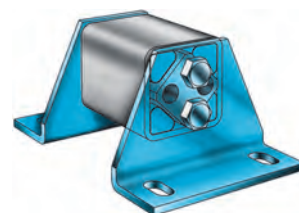

Inner square with through holes and brackets WS

Rubber suspension elements

Application examples

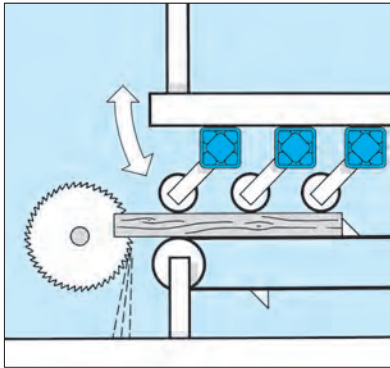

Pressure rollers in saw device

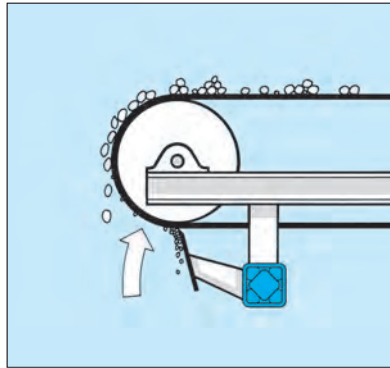

Conveyor-belt scraper

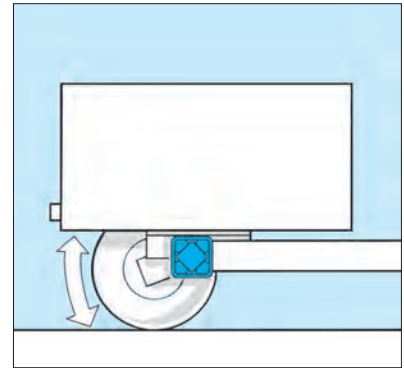

Independent wheel suspension

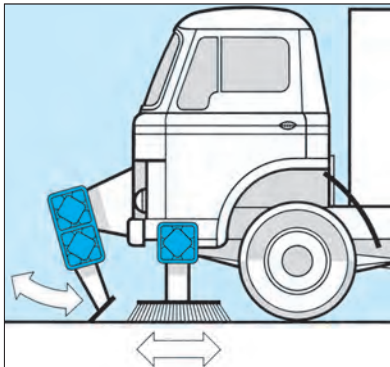

Elastic scraper / brushing joint

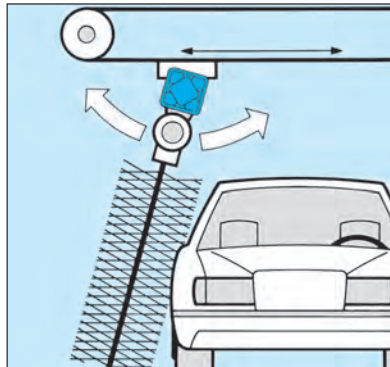

Self-aligning bearing for cleaning brushes

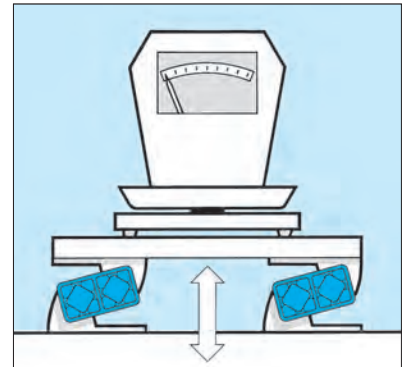

Passive insulation

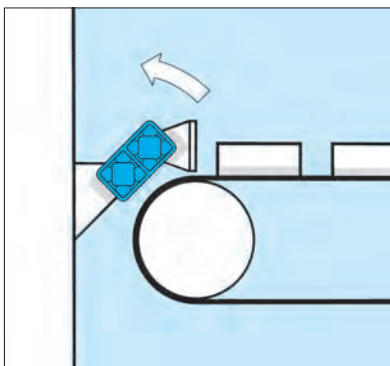

Shock absorber

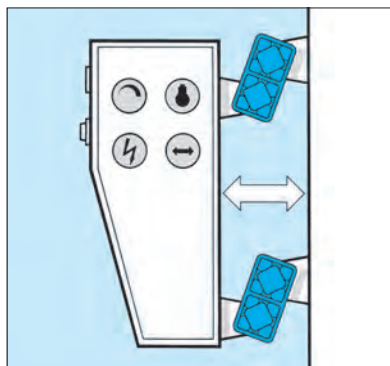

Control unit insulation

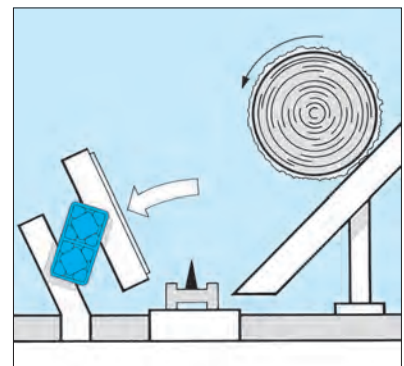

Impact suspension in feeder

OSCILLATING MOUNTINGS



Oscillating mountings – free oscillating systems

Calculation bases

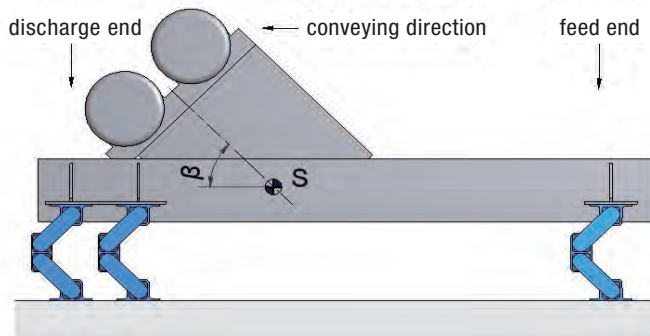

Subject	Symbol	Unit
Mass of the empty channel and drive *	m_0	kg
Products on the channel *	m_m	kg
Total vibrating mass	$m = m_0 + m_m$	kg
Mass distribution: feed end	% feed end	%
discharge end	% discharge end	%
Acceleration due to gravity	g	9.81 m/s ²
Load per corner feed end	F feed end	N
Load per corner discharge end	F discharge end	N
Working torque of both drives	AM	kgcm
Oscillating stroke empty channel	sw_0	mm
Oscillating stroke in operation	sw	mm
Motor revolutions	n_s	min ⁻¹
Centrifugal force of both drives	Fz	N
Oscillating machine factor	K	
Machine acceleration	$a = K \cdot g$	g

Calculation formulas

Loading per corner

$$F_{\text{feed end}} = \frac{m \cdot g \cdot \% \text{ feed end}}{2 \cdot 100} \quad F_{\text{discharge end}} = \frac{m \cdot g \cdot \% \text{ discharge end}}{2 \cdot 100} \quad [N]$$

Oscillating stroke

$$sw_0 = \frac{AM}{m_0} \cdot 10 \quad sw = \frac{AM}{m} \cdot 10 \quad [mm]$$

Centrifugal force

$$F_z = \frac{\left(\frac{2\pi}{60} \cdot n_s\right)^2 \cdot AM \cdot 10}{2 \cdot 1000} = \frac{n_s^2 \cdot AM}{18'240} \quad [N]$$

Oscillating machine factor

$$K = \frac{\left(\frac{2\pi}{60} \cdot n_s\right)^2 \cdot sw}{2 \cdot g \cdot 1000} = \frac{n_s^2 \cdot sw}{1'789'000} \quad [-]$$

* When determining the weight, take into account:

- High coupling or sticking of humid bulk material
- Channel running full
- Fully stacked screen deck with humid material
- Weight distribution with and without conveyed material
- Centrifugal force does not run through the center of gravity (channel full or empty)
- Sudden impact loading occurs
- Subsequent additions to the screen structure (e. g. additional screening deck)

Oscillating mountings – free oscillating systems

Vibration isolation

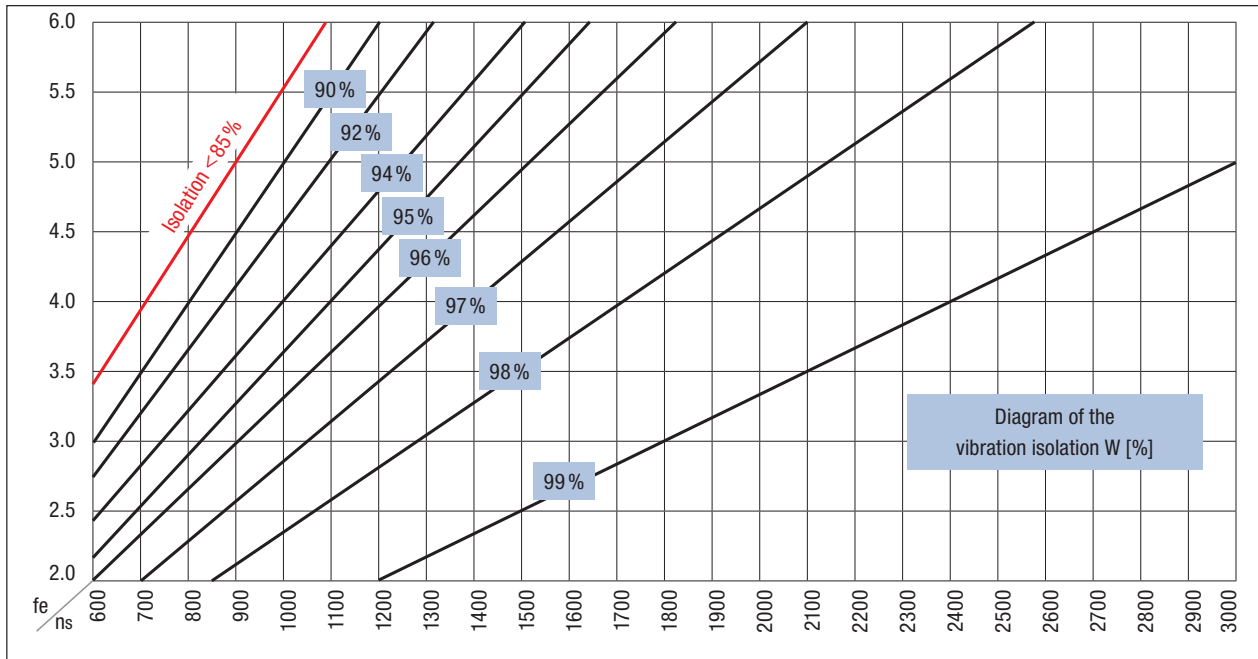

Calculation formula

$$W = 100 - \frac{100}{\left(\frac{n_s}{60 \cdot fe}\right)^2 - 1} \quad [\%]$$

Oscillating mountings – free oscillating systems

Average material conveying speed v_m

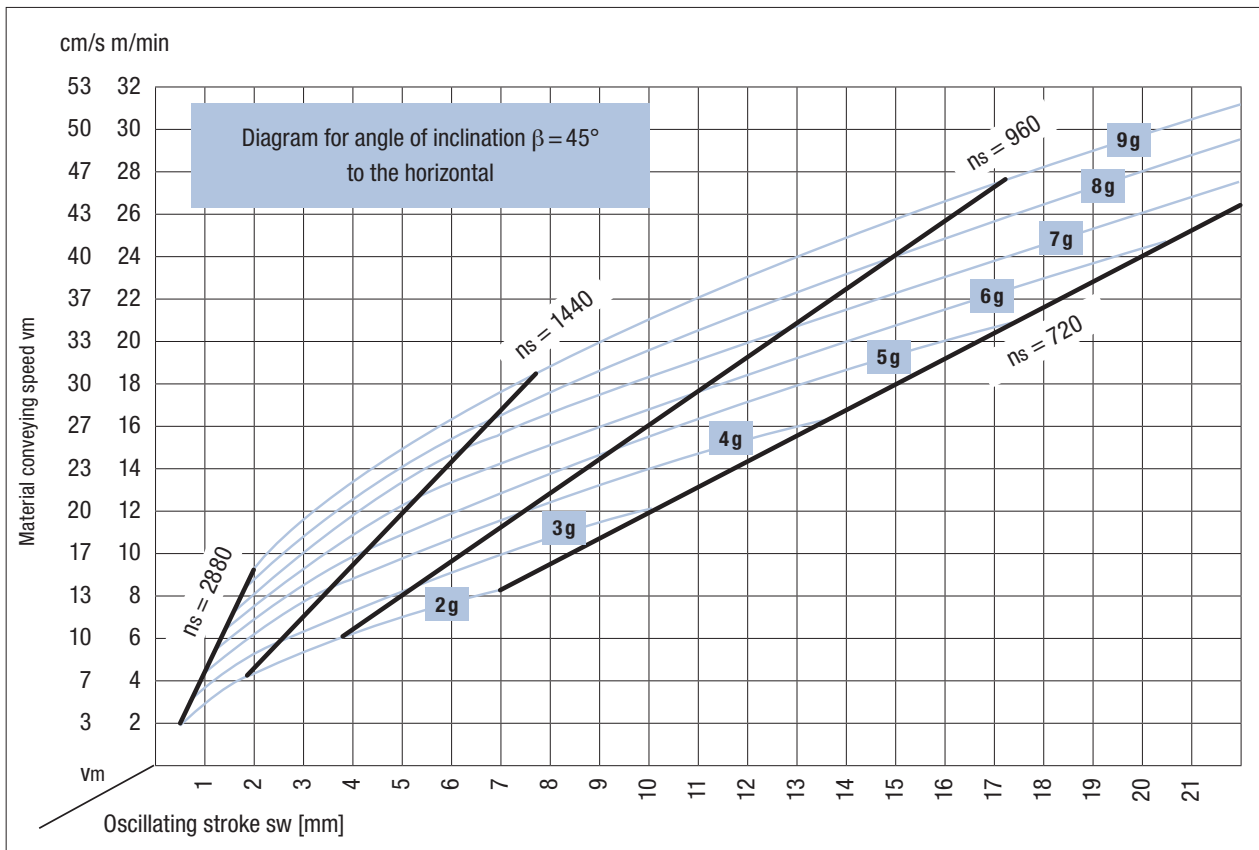

Main influencing factors

- Conveying ability of the material
- Height of the bulk goods
- Inclination of screen base
- Drive angle of the exciters in linear oscillators
- Position of the centre of gravity

The material speed on circular motion screens varies and depends largely on the tilt of the screen box.

Oscillating mountings – free oscillating systems

Operating and resonance behaviour

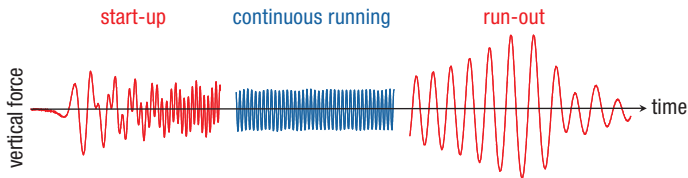

Laboratory measurements of a typical development of the residual forces on a ROSTA screen suspension.

At the screen start-up and run-out, the element's natural frequency is passed through. During the resulting amplitude superelevation, the four rubber suspension elements generate a high level of damping, which greatly reduces the vibration amplitudes. The screen box therefore stops fully after only a few strokes.

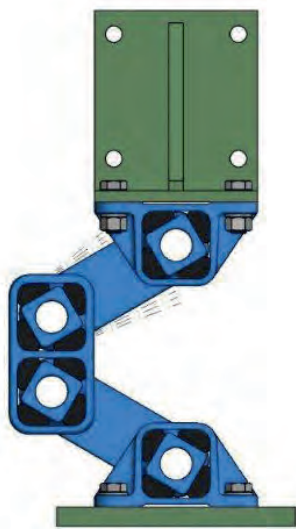

The rocker arm fixed to the screen carries out the greater part of the oscillations. The rocker arm fixed to the substructure remains virtually stationary, provides a strong cushion and ensures a low natural frequency and therefore a good insulation on the base frame.

Alignment of the elements

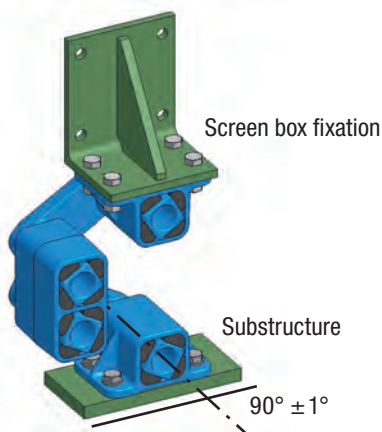

The mounting axis has to be arranged at a right angles (90°) to the conveying axis, with maximum tolerance of $\pm 1^\circ$.

Oscillating mountings – free oscillating systems

Element heights and setting behaviour AB and ABI

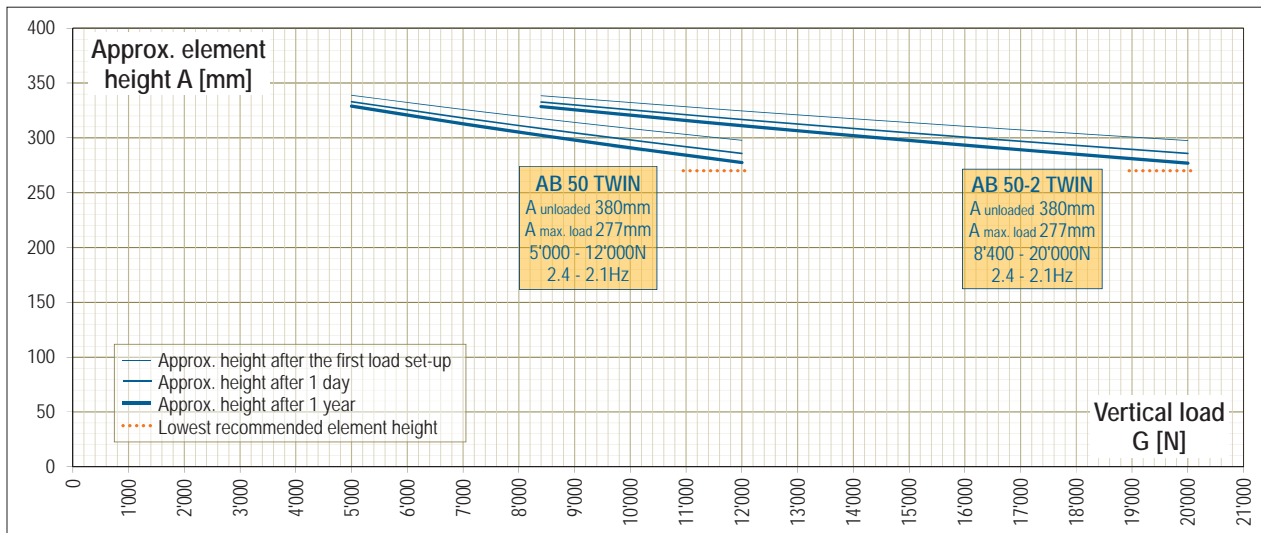
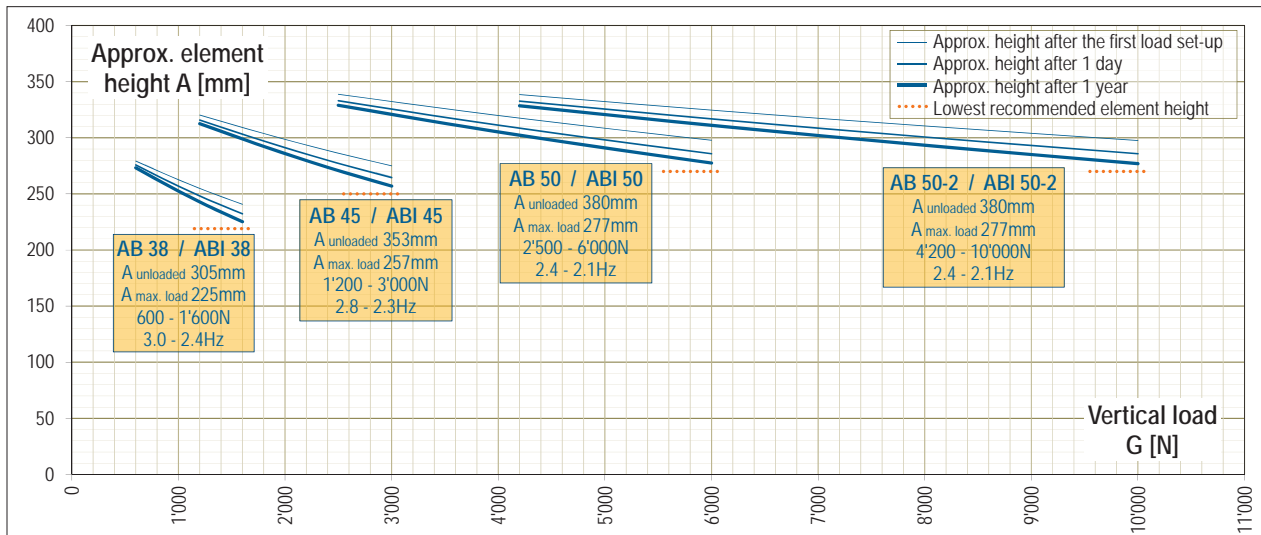
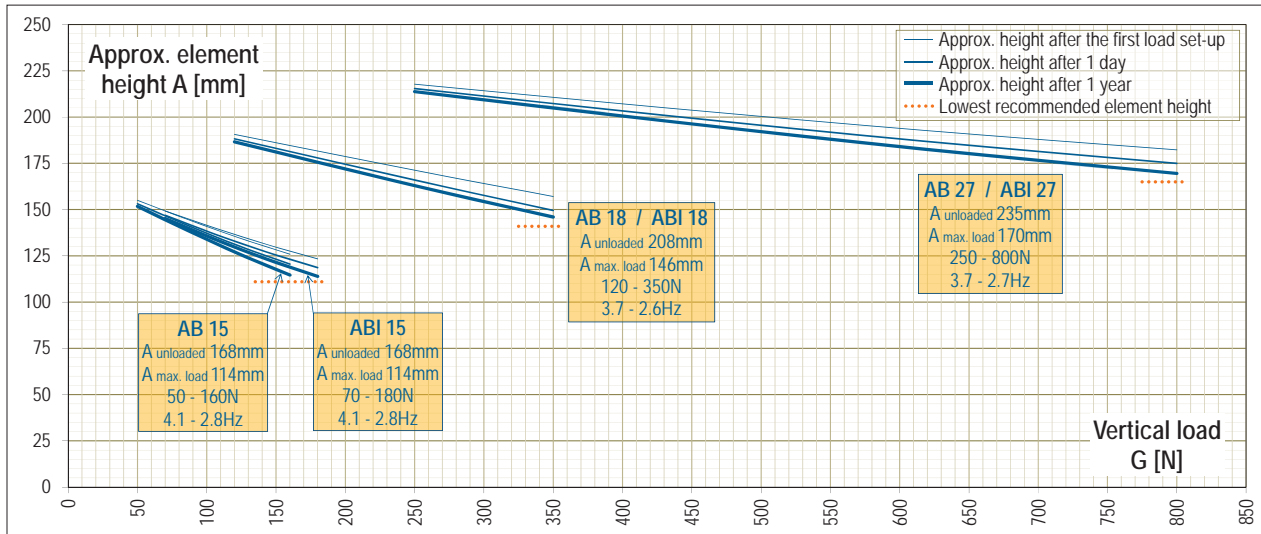

Oscillating mountings – free oscillating systems

Element heights and setting behaviour AB-HD and ABI-HD

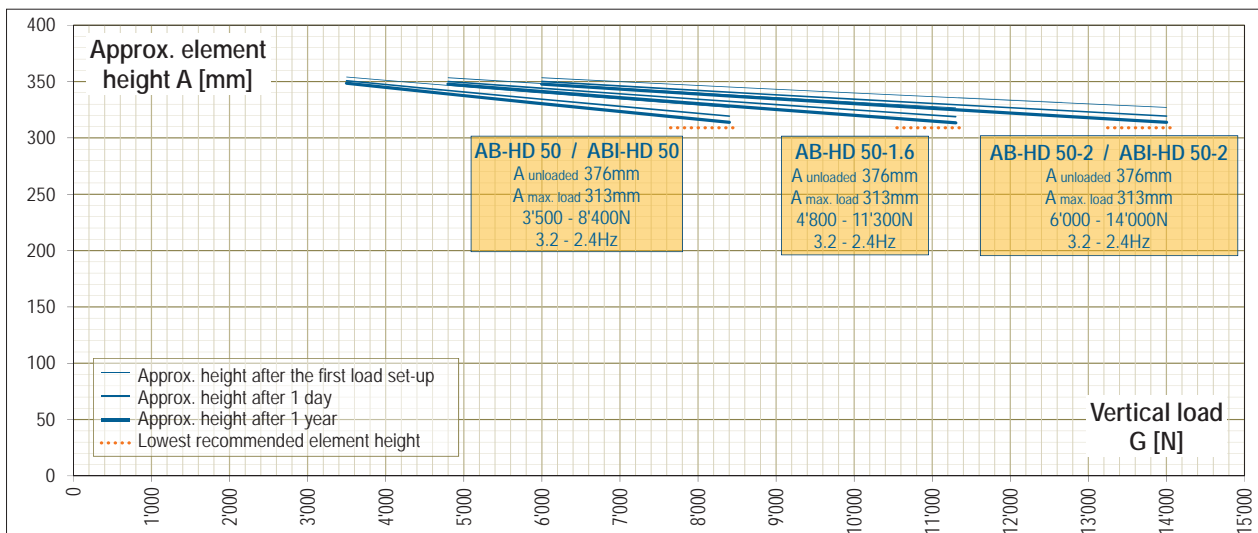
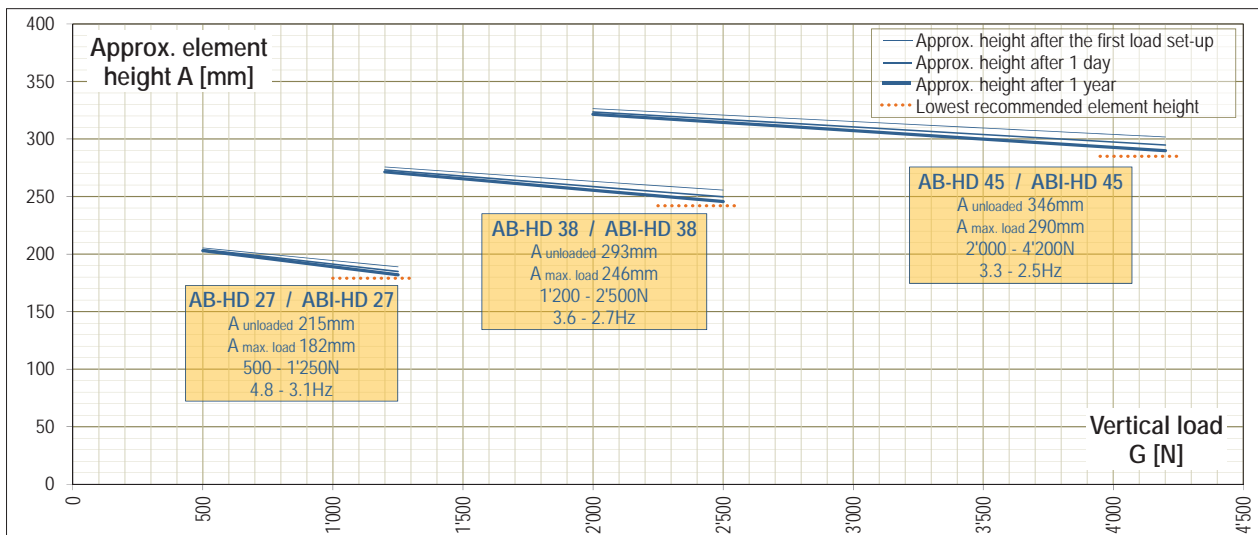
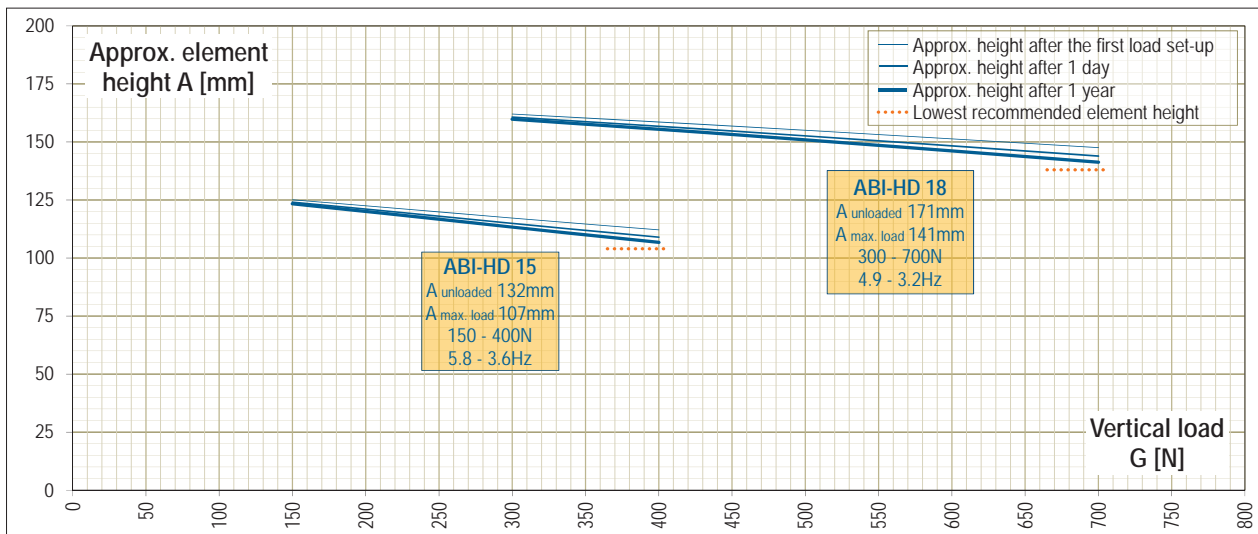

Oscillating mountings – free oscillating systems

Element heights and setting behaviour HS and HSI

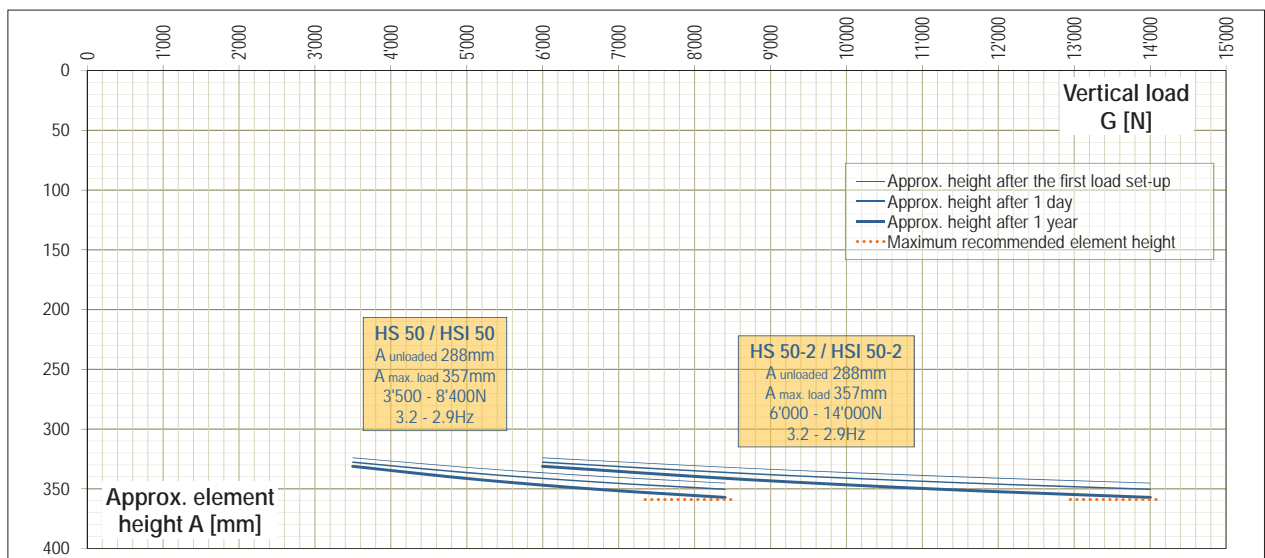
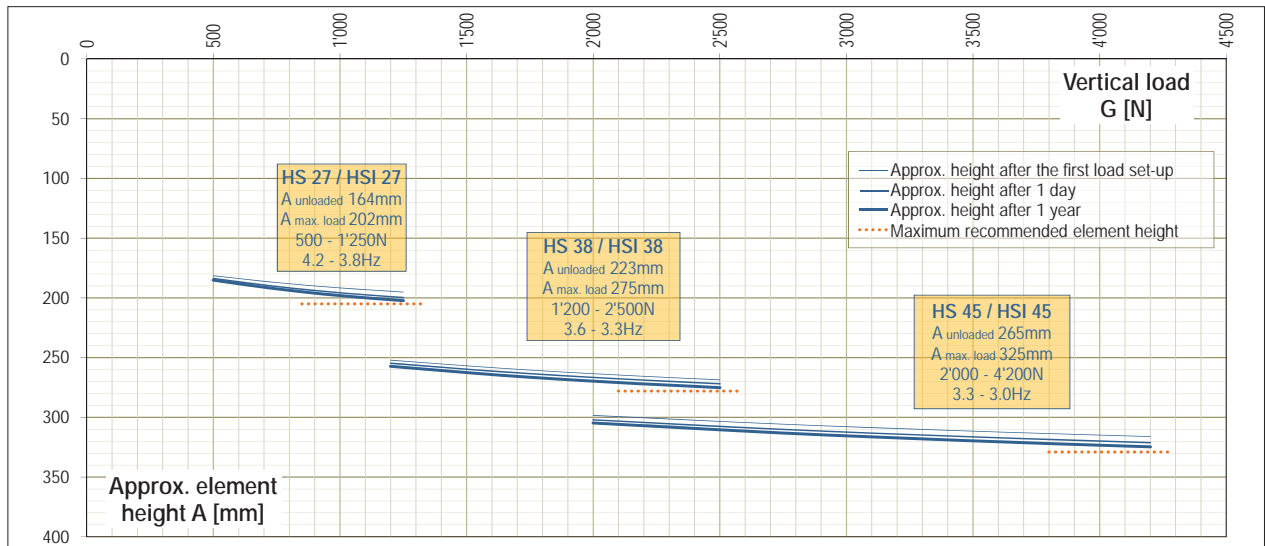
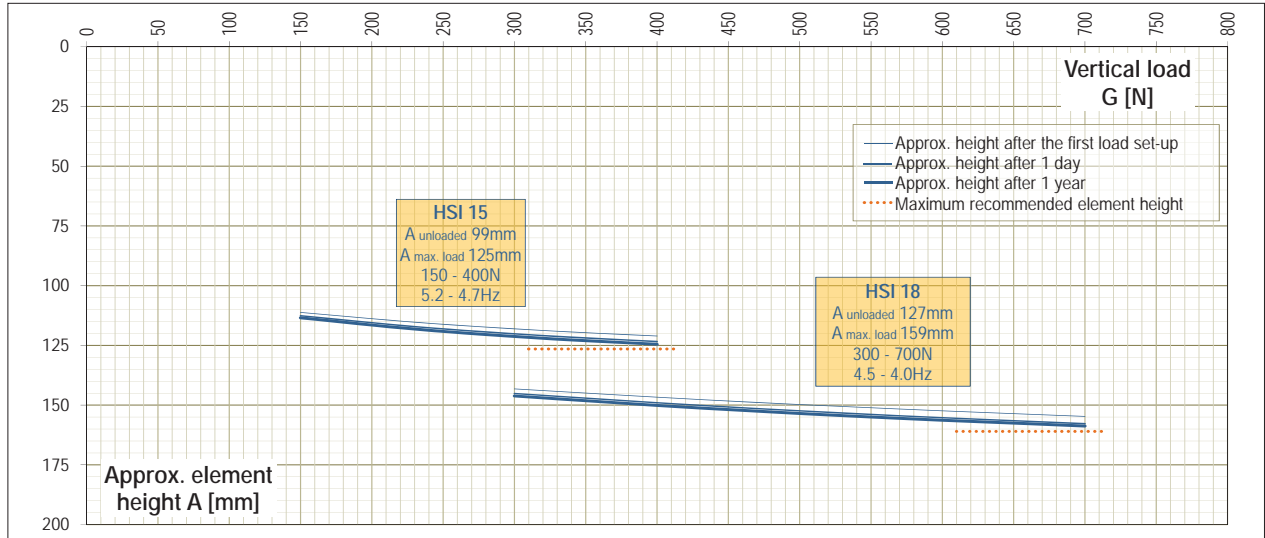

Oscillating mountings – free oscillating systems

Element heights and setting behaviour AB-D

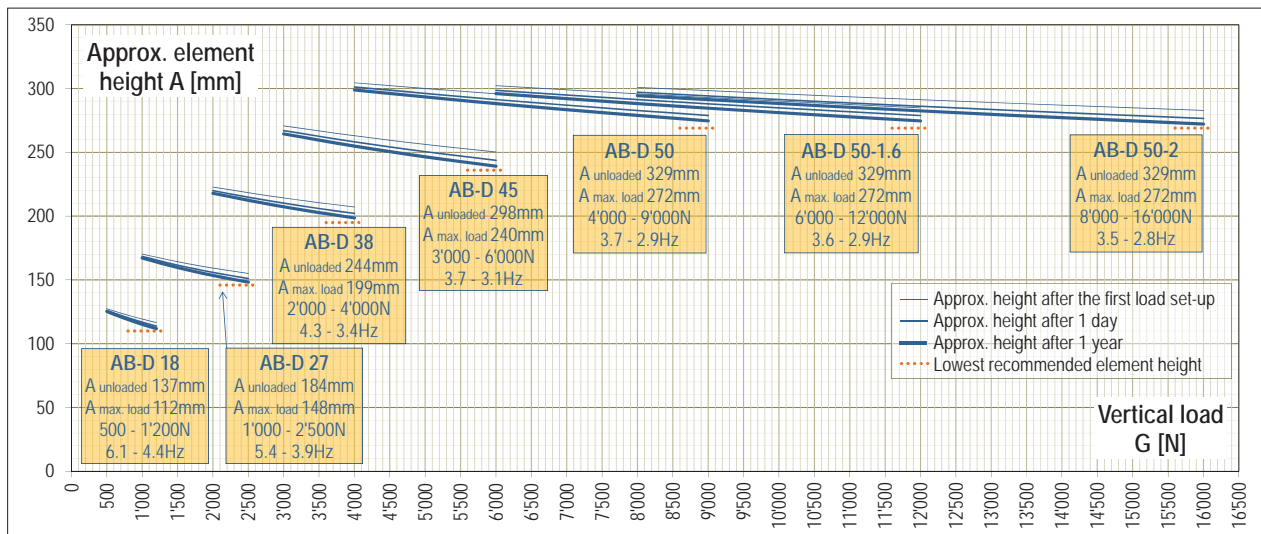

Oscillating mountings – guided systems

One mass systems without spring accumulators: calculation

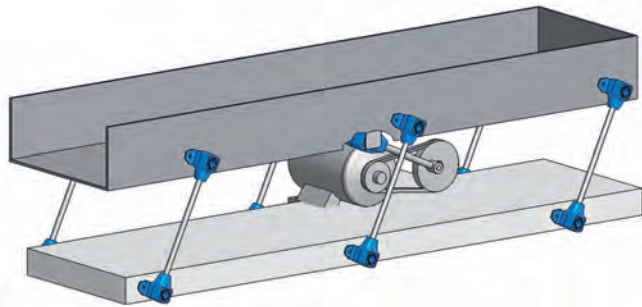

	Subject	Symbol	Unit
Length, weight	Weight empty trough *	m_0	kg
	Weight of feeding material *		kg
	Weight of oscillating mass	$m = m_0 + m_m$	kg
Drive parameter	Eccentric radius	R	mm
	Stroke	$sw = 2 \cdot R$	mm
	Rpm on trough	n_s	min ⁻¹
	Gravity acceleration	g	9.81 m/s ²
	Oscillating machine factor	K	
	Acceleration	$a = K \cdot g$	m/s ²
	Total spring value of system	c_t	N/mm
Rocker arms	Quantity of rockers **	Z	
	Load per rocker	G	N
	Center distance of elements	A	mm
Drive	Acceleration force	F	N
	Drive capacity approx.	P	kW
Spring value of natural frequency shaker	Dynamic torque	Md_d	Nm/°
	Dynamic spring value per rocker	c_d	N/mm
	Dynamic spring value of all rockers	$Z \cdot c_d$	N/mm
	Resonant ability factor	i	

- * When determining the weight, take into account:
- High coupling factor or sticking of wet and humid material
 - Possible stemming of the trough

** Distance of the rocker max. 1.5 metres.

Calculation formulas

Oscillating machine factor

$$K = \frac{\left(\frac{2\pi}{60} \cdot n_s\right)^2 \cdot R}{g \cdot 1000} = \frac{n_s^2 \cdot R}{894'500} [-]$$

Total spring value of system

$$c_t = m \cdot \left(\frac{2\pi}{60} \cdot n_s\right)^2 \cdot 0.001 \quad [\text{N/mm}]$$

Load per rocker

$$G = \frac{m \cdot g}{Z} \quad [\text{N}]$$

Acceleration force (for ST selection)

$$F = m \cdot R \cdot \left(\frac{2\pi}{60} \cdot n_s\right)^2 \cdot 0.001 = c_t \cdot R \quad [\text{N}]$$

Drive capacity approx.

$$P = \frac{F \cdot R \cdot n_s}{9550 \cdot 1000 \cdot \sqrt{2}} \quad [\text{kW}]$$

Dynamic spring value per rocker

$$c_d = \frac{Md_d \cdot 360 \cdot 1000}{A^2 \cdot \pi} \quad [\text{N/mm}]$$

Resonant ability factor

$$i = \frac{Z \cdot c_d}{c_t} [-]$$

By a resonant ability factor $i \geq 0,8$ the system is usually titled «natural frequency shaker».

Oscillating mountings – guided systems

One mass system with spring accumulators: calculation

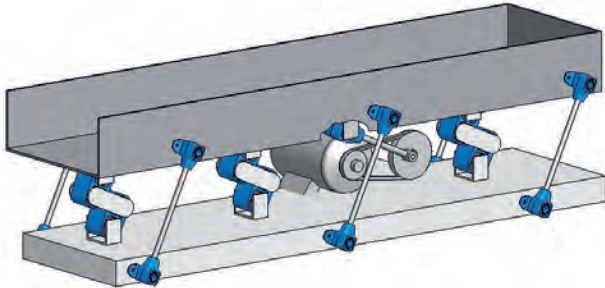

Calculation analog one mass systems without spring accumulators with following additions:

Subject	Symbol	Unit
Spring accumulators	Quantity	Z_s
	Dynamic spring value per item	C_s N/mm
	Dynamic spring value of all items	$Z_s \cdot C_s$ N/mm
	Resonant ability factor	i_s

Calculation formulas

Resonant ability factor with accumulators

$$i_s = \frac{Z \cdot C_d + Z_s \cdot C_s}{C_t} [-]$$

By a resonant ability factor is ≥ 0.8 the system is usually titled «natural frequency shaker».

One mass conveyor system: installation instructions

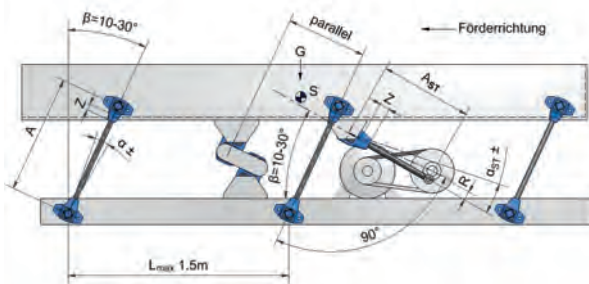

Distance between rockers L_{max} :

- Usually, the distance between the rockers in the longitudinal direction must not exceed 1.5 metres.
- With chutes wider than 1.5 m, we recommend fitting a third row or multiple rows of rockers on the underside of the chute base or to install spring accumulators to improve the stability.

Mounting position drive head ST:

For one mass shaker systems it is recommendable to position the drive head slightly ahead of the center of gravity of the trough, towards the discharge end.

Angle of attack β :

The angle of attack β of the rocker must be between 10° and 30° to the perpendicular line, depending on the process and the conveying speed. (The optimum combination of a fast conveying speed and the high material throw is given at the angle of attack $\beta = 30^\circ$.) The operating direction of the drive rod should be at 90° , i.e. the thrust angle of attack β is accordingly between 10° and 30° to the horizontal line.

Oscillation angle α :

The parameters for the oscillation angle and speed must be within the permissible range, see «permissible frequencies» in chapter 7 Technology.

Screw grade:

Select screw grade 8.8 and mount with correct tightening torque.

Thread length Z:

The thread length Z is at least $1.5 \times$ the nominal thread size.

Oscillating mountings – guided systems

Two mass system with direct mass balance

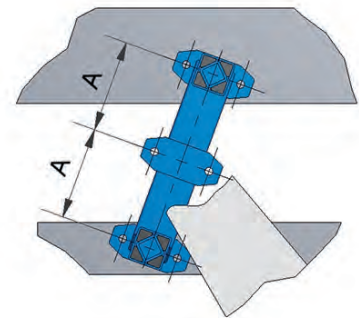
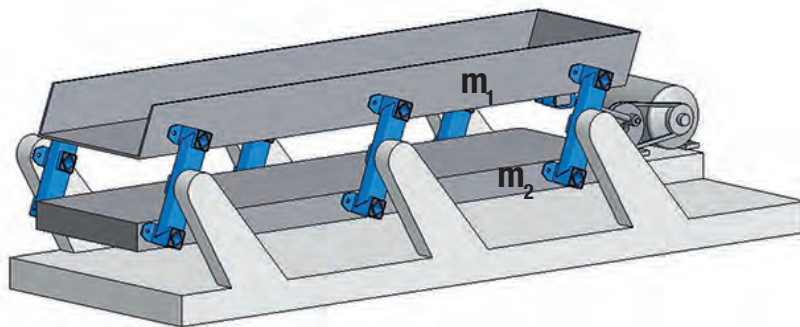

- Max. acceleration of approx. 5 g and max. chute length of approx. 25 metres
- Double rockers made from ROSTA elements AR, AD-P or AD-C
- Optimal balance of forces with $m_1 = m_2$
- Calculation same as for one mass system, with the following difference:

Actuated mass incl. material coupling	m_1 [kg]
Driven mass incl. material coupling	m_2 [kg]
Total oscillating mass	$m = m_1 + m_2$ [kg]

Dynamic spring value per rocker
[N/mm]

$$c_d = \frac{3 \cdot Md_g \cdot 360 \cdot 1000}{2 \cdot A^2 \cdot \pi} \quad [\text{N/mm}]$$

- Calculation of c_t and F with the new total oscillating mass m
- Introduction of force with the ST at any point along the chute, 90° to the rocker axis
- For customised rockers with different centre distances A , please contact ROSTA

Oscillating mountings – guided systems

Average material conveying speed v_m

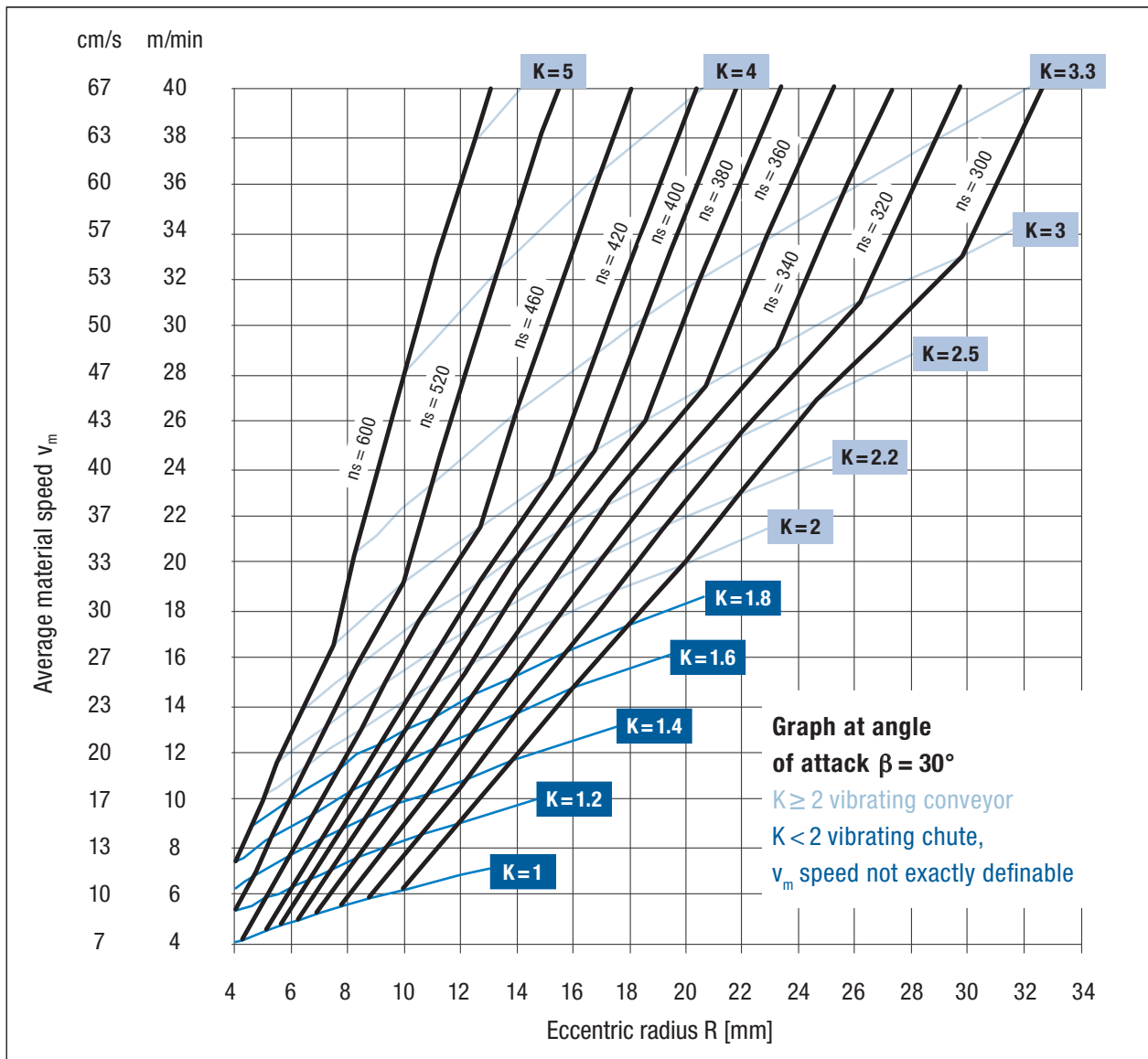

Main influence factors:

- bulk height
- sieve surface texture
- drive angle and thus rocker angle of attack
- feeding capacity is dependent on shape and humidity of the material, e.g. dry, fine-grained material needs correction factors up to 30%.

By acceleration factors $K > 2$ and rocker mounting angles of $\beta = 30^\circ$ (to the perpendicular line) the vertical acceleration is getting bigger than 1g, therefore the material starts lifting from the trough bottom = material throw.

Oscillating mountings – guided systems

Maximum load G, speed n_s and oscillation angle α

Size (e. g. AU 15)	max. load capacity per rocker [N]				max. revolutions n_s [min ⁻¹]*	
	K < 2	K = 2	K = 3	K = 4	$\alpha \pm 5^\circ$	$\alpha \pm 6^\circ$
15	100	75	60	50	640	480
18	200	150	120	100	600	450
27	400	300	240	200	560	420
38	800	600	500	400	530	390
45	1600	1200	1000	800	500	360
50	2500	1800	1500	1200	470	340
60	5000	3600	3000	2400	440	320

Please contact ROSTA for higher machine parameters and elements with greater loads.
The revolutions are usually $n_s = 300$ to 600 min^{-1} and oscillation angle α to max. $\pm 6^\circ$.
*see «permissible frequencies» in chapter 7 Technology.

The oscillation angle α of each component must be within the permissible range of application (n_s and α), i.e. rockers, drive rods and spring accumulator.

Calculating the oscillation angle for rockers

Eccentric radius R [mm]

Center distance A [mm]

Oscillation angle $\alpha \pm [^\circ]$

$$\alpha = \arctan\left(\frac{R}{A}\right) [^\circ]$$

AU / AU1: Connection rod

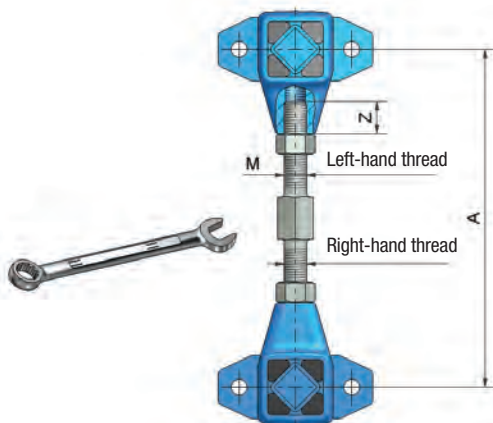

The customer manufactures the connection rod, preferably with a left and right-hand thread. Together with the corresponding oscillating mountings, the distance between the mountings (A) can be freely adjusted. Using a standard threaded rod (with «only» a right-hand thread) may be more economical, but it is less accurate.

The centre distance A must be set identically for all rockers and the thread length Z must be at least $1.5 \times M$.

AS / AD: Resulting oscillation angle α from eccentric radius R

Single rocker AS

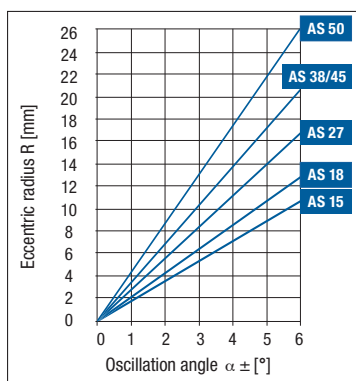

Double rocker AD

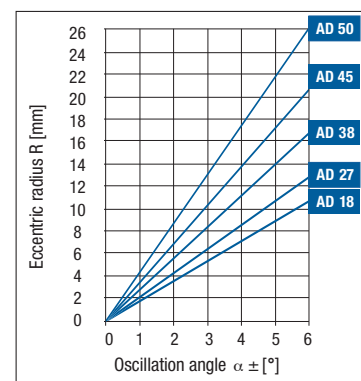

Oscillating mountings – guided systems

AR: Single, double and two-way Rocker

Single rocker

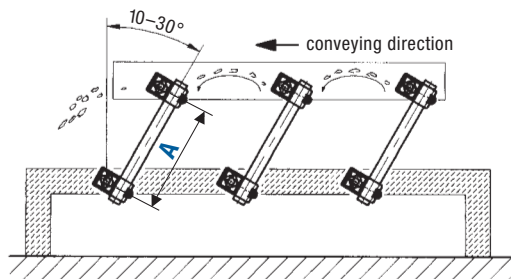

The two AR elements are pushed onto a round tube. The desired center distance is set on a straightening plate and then fixed by tightening the clamp.

Double rocker

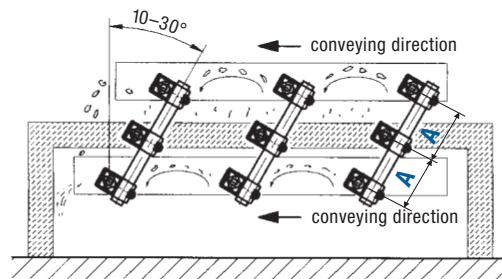

With three AR elements, the tube wall thickness is adjusted to the centre distances A, see «dimensioning of the connecting tubes». The counterweight can be used as an additional conveyor trough with the same conveying direction.

Two-way rocker

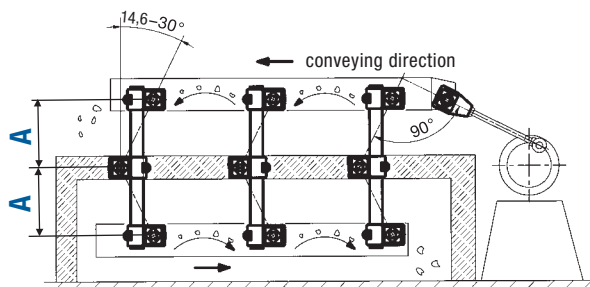

The three AR elements mounted in the boomerang configuration create a two-way material flow. Tube wall thickness according to «dimensioning of the connecting tubes». This two-way conveying flow can simplify the conveying process and the mass balance is maintained with this arrangement.

AR: Dimensioning of the connecting tubes

For double rockers and two-way rocker

Type	Tube- ϕ	thickness of tube	max. centre distance A	resulting min. angle of attack β [°] with two-way rocker
AR 27	30	3	160	26.0
		4	220	19.5
		5	300	14.6
AR 38	40	3	200	27.5
		4	250	22.6
		5	300	19.1
AR 45	50	5	300	23.4
		8	400	18.0

The customer provides the connecting tubes.

For single rockers with AR 27 or AR 38, it is sufficient for the tubes to have a wall thickness of 3 mm up to A = 300 mm.

For different centre distances A, please contact ROSTA.

Oscillating mountings – guided systems

ST/STI: Length of drive rod A_{ST} and eccentric radius R

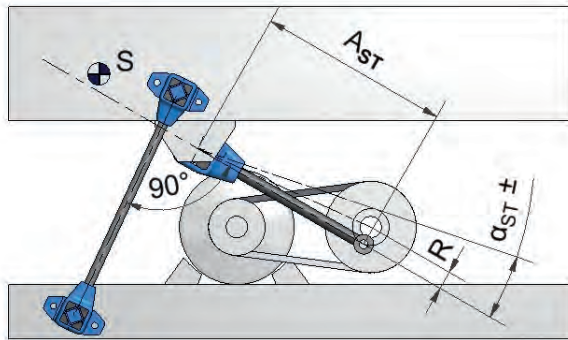

To introduce the force in balance, the deflection angle α_{ST} of the drive rod must not exceed $\pm 5.7^\circ$. This corresponds to a ratio $R:A_{ST}$ of 1:10.

Calculation deflection angle

Eccentric radius R [mm]

Center distance A_{ST} [mm]

Deflection angle $\alpha_{ST} \pm [^\circ]$

$$\alpha_{ST} = \arcsin \left(\frac{R}{A_{ST}} \right) [^\circ]$$

DO-A: Operating parameters and installation guidelines

Example deflection angle DO-A (series connection)	Accumulator cons. of 2 x DO-A 45				Accumulator cons. of 2 x DO-A 50			
	R	sw	max. n_s	max. K	R	sw	max. n_s	max. K
$\pm 6^\circ$	15.3	30.6	360	2.2	16.4	32.8	340	2.1
$\pm 5^\circ$	12.8	25.6	500	3.6	13.6	27.2	470	3.4
$\pm 4^\circ$	10.2	20.4	740	6.2	10.9	21.8	700	6

The connecting levers made by the customer, between the DO-A elements, are at 90° to the DO-A element axis. A cross bracing can be installed (V) if required. The DO-A elements are parallel to each other and parallel to the rockers; they are attached by means of a fork construction at a rigid point on the vibrating conveyor and base frame.

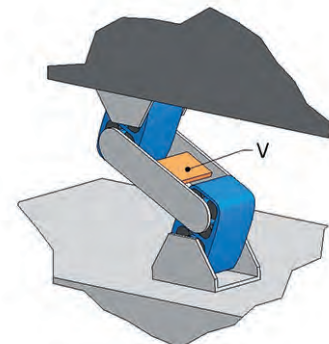
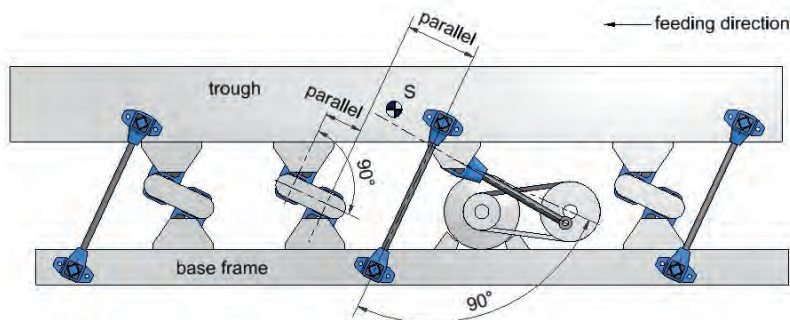

Oscillating mountings – gyratory sifters

AK: Installation guidelines for gyratory sifters

1. Arrange the two inner elements offset by 90° (even torsional load).
2. Connect the AK, adjust the installation height. Even when the sifters are at an angle, the column height «X» must be identical.
3. Angle supports type WS can be used up to AK 50 (see chapter 2 rubber suspension elements).
4. To avoid unwanted tilting and turning, the screen box's centre of gravity «S» is positioned on or within the universal joint column.

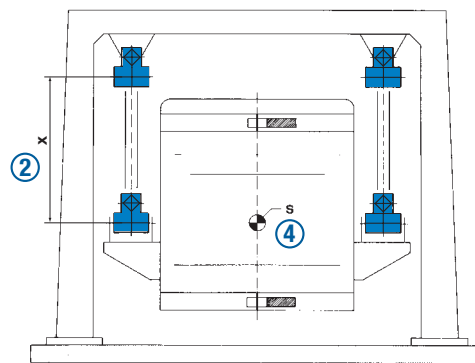
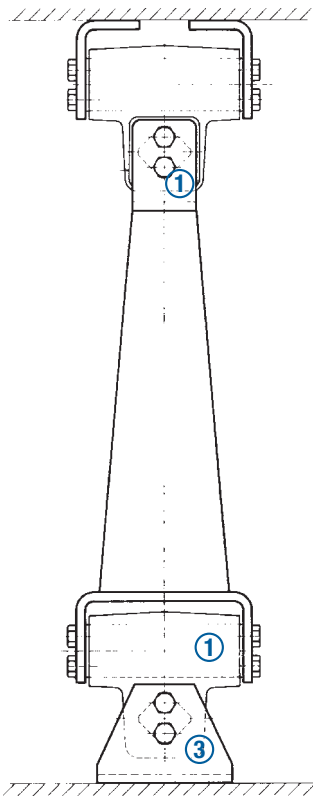

Hanging and freely oscillating gyratory sifter

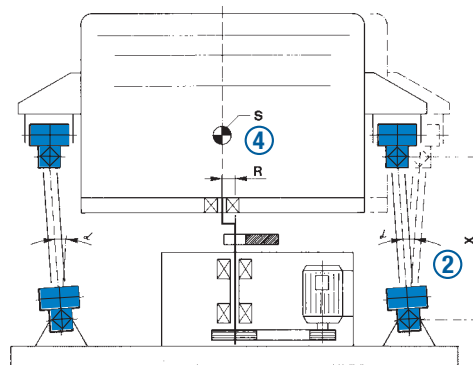

Standing gyratory sifter with positive crank shaft drive

AK: Calculation for gyratory sifters

Machine type: standing gyratory sifter with positive crank drive

Description	Symbol	Unit	Calculation formula
Total oscillating mass (material included)	m	kg	Oscillation angle $\alpha = \arctan\left(\frac{R}{X}\right) [^\circ]$
Eccentric radius	R	mm	
Length of support column	X	mm	
Oscillation angle (out of R and X)	$\alpha \pm$	°	Load per column $G = \frac{m \cdot g}{z} [N]$
Quantity of support columns	z	pcs.	
Load per column	G	N	

Limitation of application parameters see «permissible frequencies» in chapter 7 Technology.

Oscillating mountings – gyratory sifters

AV: Installation guidelines for gyratory sifters

1. With the right-hand and left-hand threaded versions, the length X of the suspension rod can easily be adjusted. X has to be identical for all columns and the specified angle limitations must be respected!
2. Installing the two elements in a crosswise configuration moves the gyratory sifter in a circular motion.
3. Installing the two elements in the same configuration moves the gyratory sifter in an elliptical motion.
4. To avoid unwanted tilting or turning, the centre of gravity of the screen box «S» is positioned at the same level or slightly below the suspension rod's attachment.
5. Please consult ROSTA in the selection of AV elements for standing gyratory sifters.

② circular oscillation

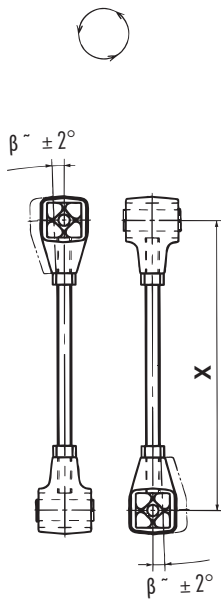

③ elliptical oscillation

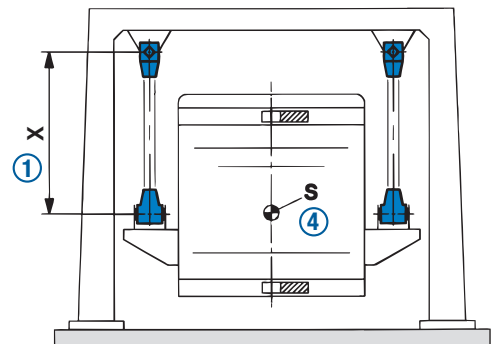
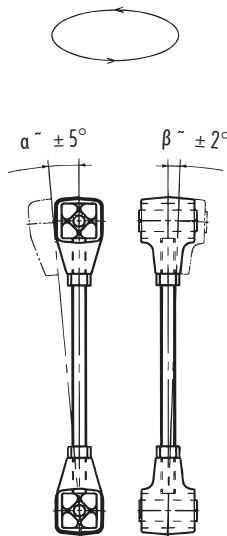

AV: Calculation for gyratory sifters

Description	Symbol	Unit	Calculation formula
Total oscillating mass (material included)	m	kg	Oscillation angle
Eccentric radius ②	R	mm	
Length of suspension rod	X	mm	$\beta = \arctan\left(\frac{R}{X}\right) [^\circ]$
Oscillation angle (out of R and X), shall not exceed $\pm 2^\circ$ ②	$\beta \pm$	°	Load per suspension rod
Quantity of suspension rods	Z	pcs.	
Load per suspension rod	G	N	

$$G = \frac{m \cdot g}{z} [N]$$

Limitation of application parameters see «permissible frequencies» in chapter 7 Technology.

VIBRATION DAMPERS



Vibration dampers

Isolation of oscillations and shocks

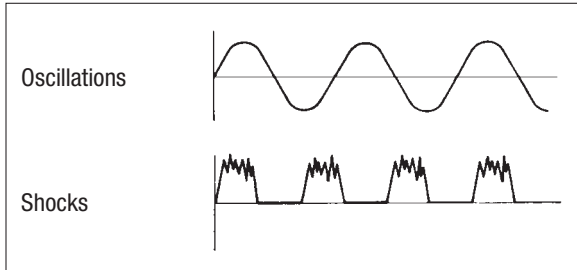

Manufacturers of vibration dampers usually offer different designs of machine mounts with varying natural frequencies, to meet the required detuning between the excitation frequency of the machine to be mounted and the natural frequency of the damper.

The vibration technology basically differentiates between two different oscillation patterns. Oscillations are usually eradicated with supercritical designed machine mounts, while shocks are eradicated with subcritical ones.

Frequency proportion λ

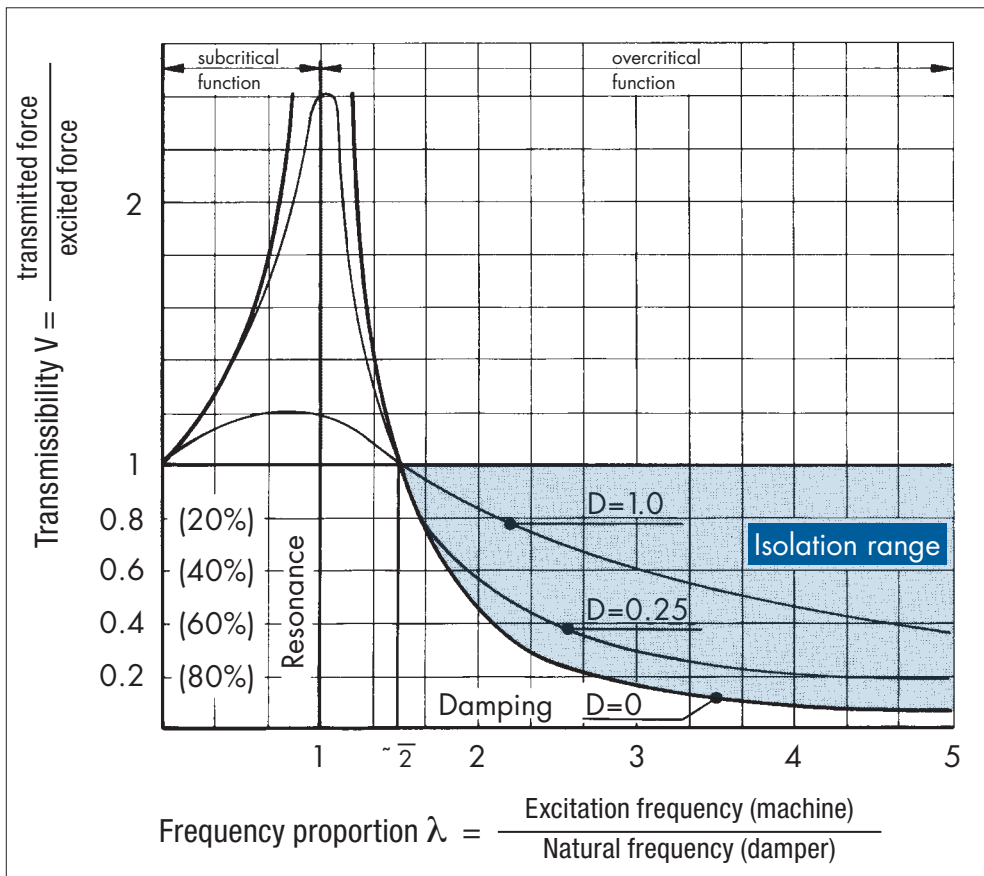

- $\lambda > \sqrt{2}$: Overcritical: vibration isolation, definable effectiveness W , and efficient structure-borne sound insulation
- $\lambda = 1$: Resonance range: amplified resonance, maximum values depend on the internal insulation D within the resonance range
- $\lambda < 1$: Subcritical: no definable vibration isolation and lower structure-borne sound insulation

Vibration dampers

Overcritical installations ($\lambda > \sqrt{2}$)

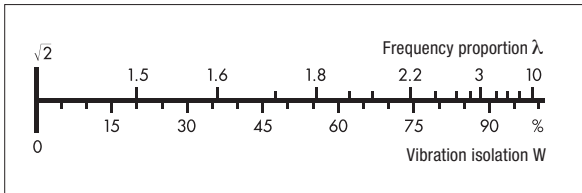

For overcritical mounts, the natural frequency values of the mounts must be at least $\sqrt{2}$ below the excitation frequencies of the machine or unit. As a rule, a damper with a relatively large spring deflection performance under load is selected. Most units, compressors, motors, blowers and generators are mounted overcritical making them relatively «soft». The resulting frequency ratio provides information about the expected isolation effectiveness of the mount. The line scale opposite and the calculation give the expected insulation W as a %.

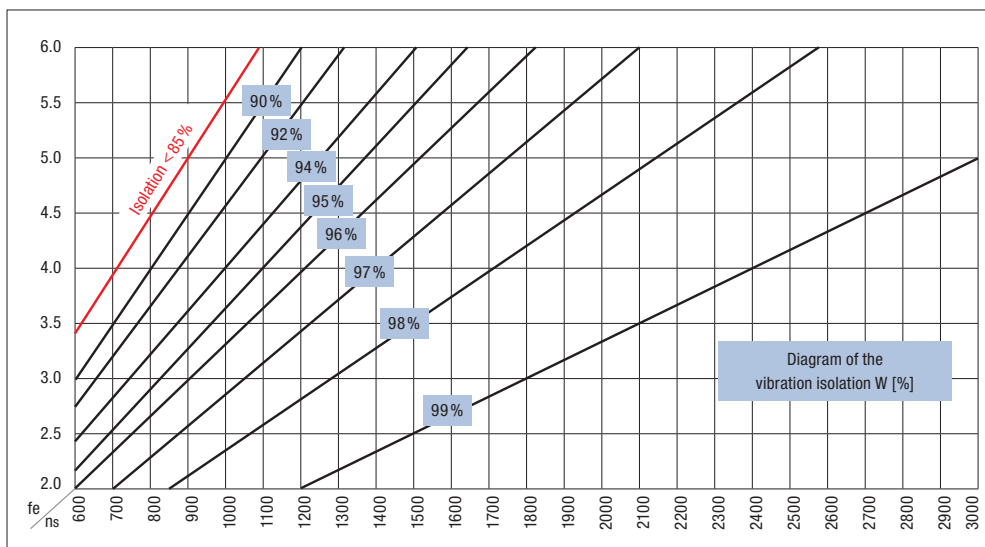

$$W = 100 - \frac{100}{\left(\frac{n_s}{60 \cdot f_e}\right)^2 - 1} [\%]$$

n_s =
Revolution exciter
(machine) [rpm]

f_e =
Natural frequency damper
[Hz]

Subcritical installations ($\lambda < 1$) and resonance range ($\lambda = 1$)

Subcritical installations

A damper with high mechanical strength and low deflection behaviour (high mounting stability) is usually used on subcritical mounts. With this type of mounting, it is possible to damp impacts and shocks from relatively slow-moving machines such as mixers, crushers (cone crushers), punching presses, shears, etc. On machines with subcritical mounts, the resulting efficacy of the isolation insulation cannot be calculated – it can only be determined by comparing the values before and after.

Resonance range

Any coincidence between the exciter frequency and the natural frequency of the damper lead to an undesired, uncontrollable swinging up of the machine to be stored.

Vibration dampers

ESL: Deflection curves and setting behaviour

The deflection graphs already contain an initial cold flow that occurs after the first hours of operation. The final cold flow is approx. $s \times 1.09$. These deflection values are based on our catalogue data and are to be taken as guidelines. Please also refer to our tolerance data in chapter 7 «Technology – ROSTA Basics».

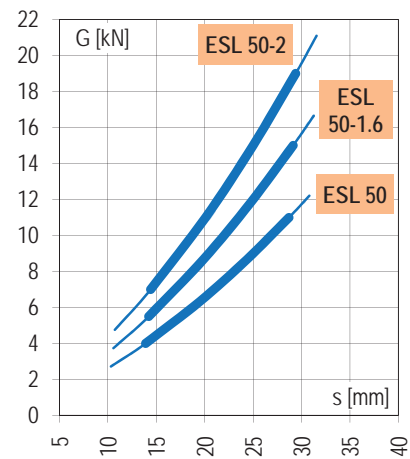
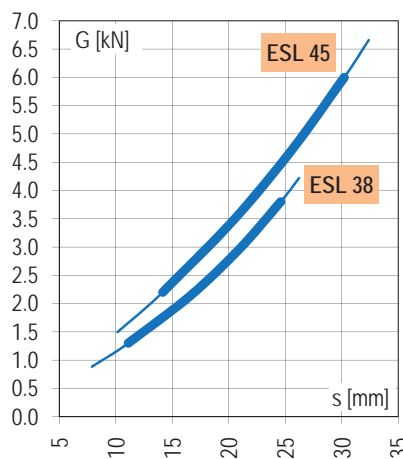
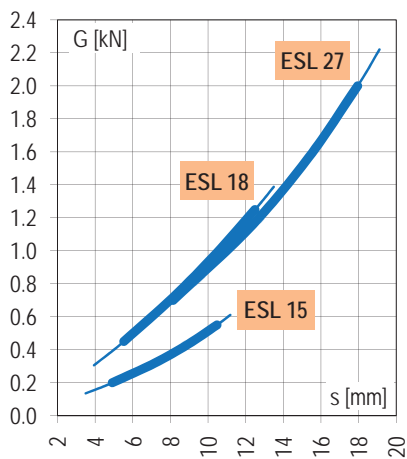
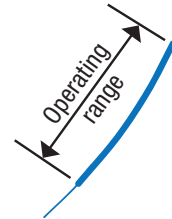

ESL: Installation guidelines

The ESL elements must generally be installed in the same direction.

Dynamic forces longitudinal

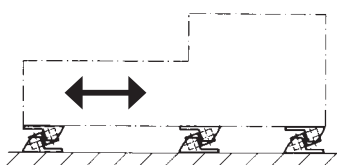

Dynamic forces lateral

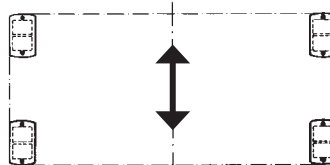

Wall mounting

(Please follow mounting direction)

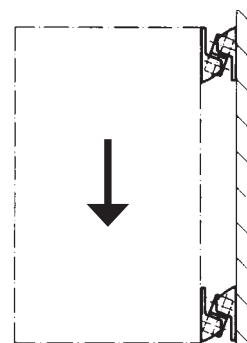

Vibration dampers

ESL: Transfer stations in belt conveyor systems

Size and quantity of ESL for the absorption of the occurring kinetic energy

Weight biggest lump [kg]	Drop height [m]																		
	1.0	1.5	2.0	2.5	3.0	3.5	4.0	4.5	5.0	5.5	6.0	6.5	7.0	7.5	8.0	8.5	9.0	9.5	10.0
5	4	4	4	4	4	4	4	4	4	4	4	4	4	4	4	4	4	4	4
10	4	4	4	4	4	4	4	4	4	4	4	4	4	4	4	4	4	4	4
20	4	4	4	4	4	4	4	4	4	6	6	6	6	6	6	6	6	6	6
30	4	4	4	4	4	6	6	6	6	6	6	6	6	6	8	8	8	8	8
40	4	4	4	4	6	6	6	6	6	6	8	8	8	8	6	6	6	6	6
50	4	4	4	6	6	6	6	6	8	8	8	6	6	6	6	6	6	8	8
60	4	4	6	6	6	6	8	8	8	6	6	6	6	6	8	8	8	8	8
70	4	6	6	6	6	8	8	6	6	6	6	6	8	8	8	8	8	8	8
80	4	6	6	6	8	8	6	6	6	6	8	8	8	8	8	8	8	8	8
90	4	6	6	6	8	6	6	6	6	8	8	8	8	8	8	8	8	8	8
100	4	6	6	8	8	6	6	6	8	8	8	8	8	8	8	8	8	8	8
110	6	6	6	8	6	6	6	8	8	8	8	8	8	8	8	8	8	10	10
120	6	6	8	8	6	6	8	8	8	8	8	8	8	8	8	10	10	10	10
130	6	6	8	6	6	6	8	8	8	8	8	8	8	8	10	10	10	10	12
140	6	6	8	6	6	8	8	8	8	8	8	8	8	10	10	10	10	12	12
150	6	6	8	6	6	8	8	8	8	8	8	8	10	10	10	12	12	12	12
200	6	8	6	8	8	8	8	8	8	10	10	12	12	12	14	14	16	16	16
300	8	6	8	8	8	10	10	12	12	14	16	16							
400	6	8	8	8	10	12	14	16	16										
500	8	8	8	10	12	14	16												

Type	Max. absorption of energy per ESL
ESL 38	250 Nm
ESL 45	375 Nm
ESL 50	750 Nm
ESL 50-1.6	1 000 Nm
ESL 50-2	1 250 Nm

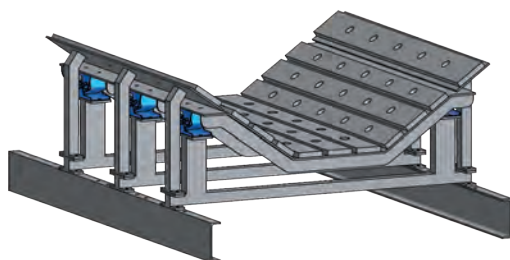

Transfer stations equipped with ROSTA Type ESL vibration dampers offer a progressive deflection characteristic that effectively dampens the kinetic energy created when the falling material makes impact. This protects the surface of the belt's coating from cracking, dramatically reduces the level of continuous material wear and protects the substructure from premature failure.

Vibration dampers

AWI: Deflection curves and setting behaviour

The deflection graphs already contain an initial cold flow that occurs after the first hours of operation. The final cold flow is approx. $s \times 1.09$. These deflection values are based on our catalogue data and are to be taken as guidelines. Please also refer to our tolerance data in chapter 7 «Technology – ROSTA Basics».

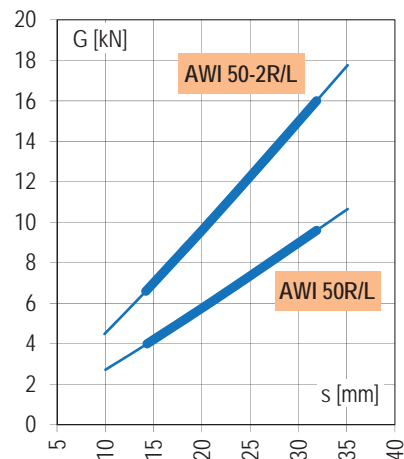
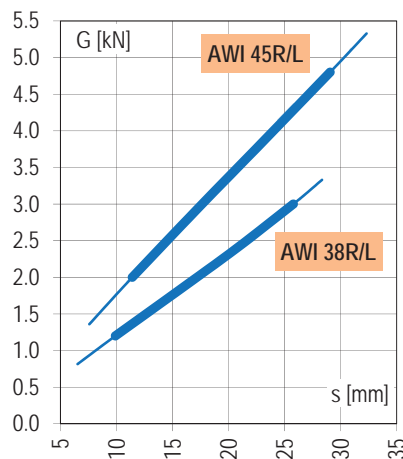
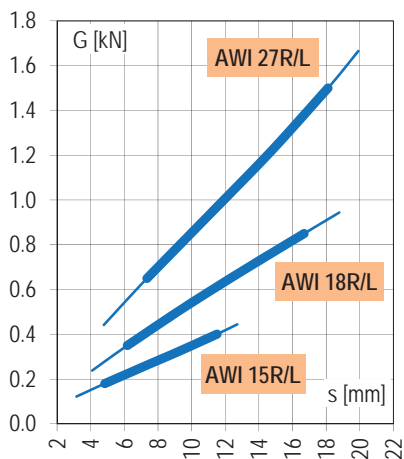

AWI: Installation guidelines

The AWI elements must generally be installed in the same direction.

Dynamic forces longitudinal

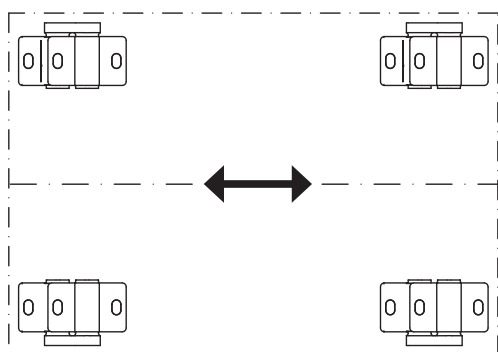

Dynamic forces lateral

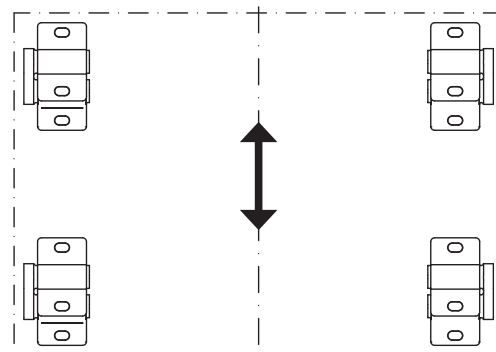

Vibration dampers

V: Deflection curves and cold flow behaviour

These deflection values are based on our catalogue data and are to be taken as guidelines. Please also refer to our tolerance data in chapter 7 «Technology – ROSTA Basics».

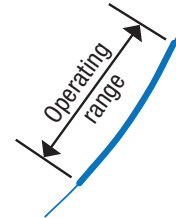
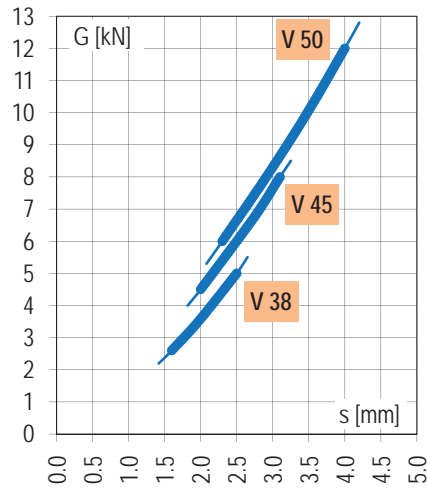
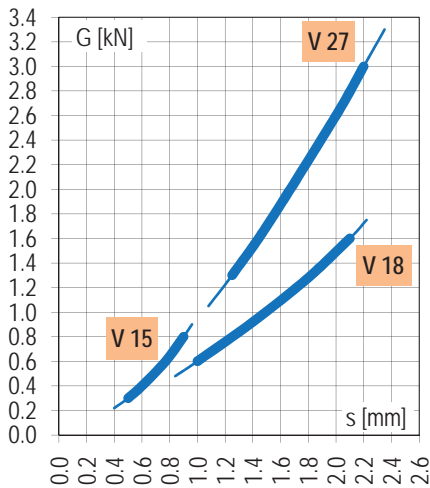

V: Installation guidelines

The V elements installed in the same direction hold load to G_{max} in X- and Z-direction.

Dynamic forces longitudinal

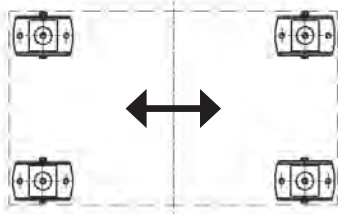

Dynamic forces lateral

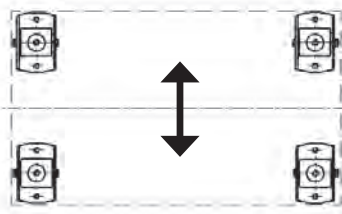

45° diagonal configuration by rotary motions. Reduced load capacities.

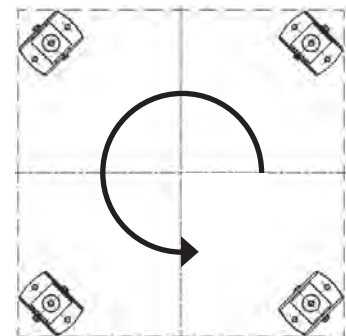

Vibration dampers

NE: Maximum load and options

Maximum load sizes NE 50-12 to 400-12:

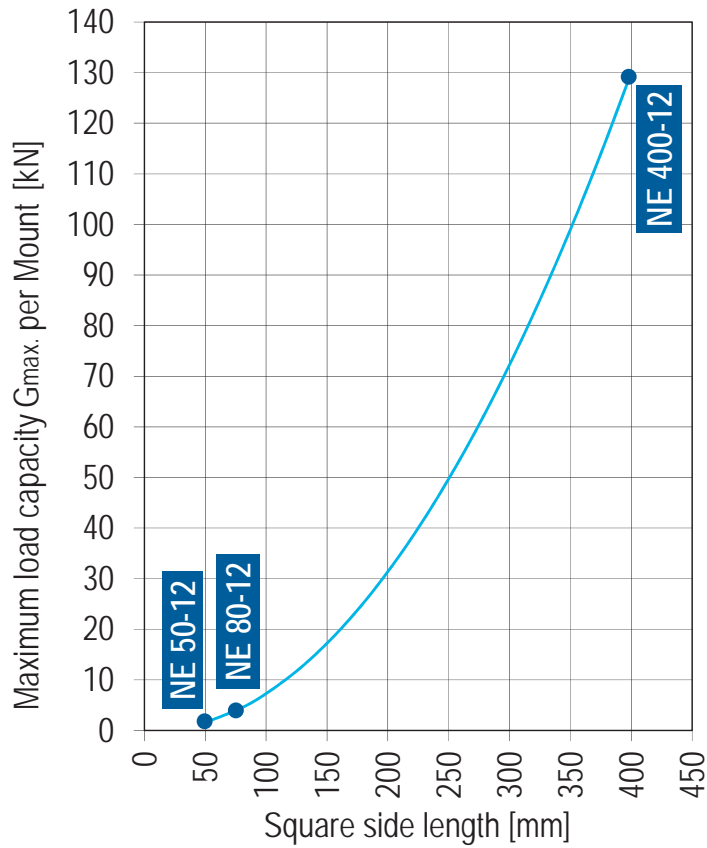

Options on request:

- Adhesive layer
- Different length and width, maximum dimensions are 1.5 × 5 m.
- Material thickness of 8, 12.5 and 25 mm; multiple thickness 37.5 and 50 mm.

TENSIONER DEVICES



Tensioner devices

Tensioner device

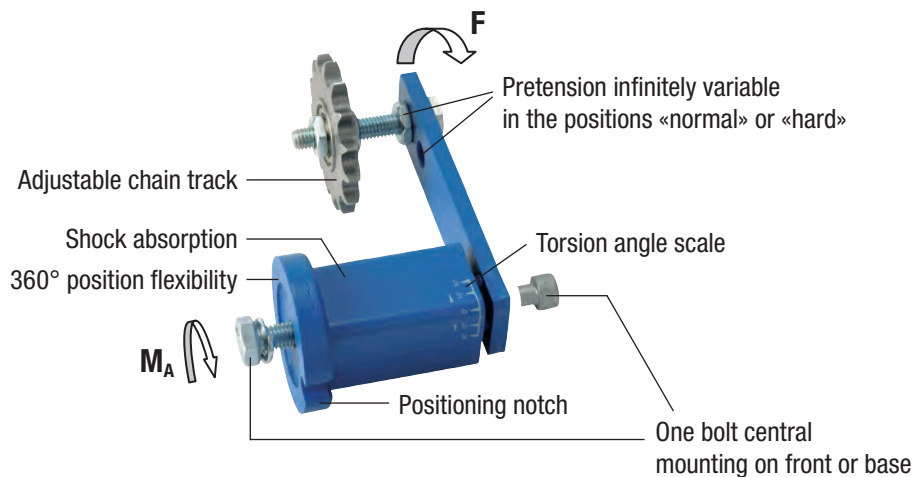

Tensioning force F

Tensioning forces for lever position «normal» for SE/SE-G/SE-R/SE-F/SE-I

Size SE	Pre-tension $\leq 10^\circ$		Pre-tension $\leq 20^\circ$		Pre-tension $\leq 30^\circ$	
	F [N]	s [mm]	F [N]	s [mm]	F [N]	s [mm]
11	18	14	48	27	96	40
15	25	17	65	34	135	50
18	75	17	185	34	350	50
27	150	23	380	44	810	65
38	280	30	720	60	1500	88
45	520	39	1350	77	2650	113
50	740	43	2150	86	4200	125

The tensioning force can be continuously adjusted. The max. pre-tensioning angle is 30° out of neutral position.

When fixing the sprockets, riders and rollers in arm-position «hard», tensioning force will increase on about 25%.

SE-W: 40% lower tensioning force than standard versions (Rubmix 40).
SE-FE: see SE-FE in chapter 5.

Tightening torque M_A

	Quality 8.8	Quality 12.9 for SE-F/SE-FE
M6	10 Nm	17 Nm
M8	25 Nm	41 Nm
M10	49 Nm	83 Nm
M12	86 Nm	145 Nm
M16	210 Nm	355 Nm
M20	410 Nm	690 Nm
M24	750 Nm	

Table mentioning the tightening torque for the central screw (included in scope of delivery).

Tensioner devices

Installation guidelines

«Z» layout

If chain tensioning wheels/chain sliders or tension rollers are mounted on the outer lever side, the distance «Z» should be as low as possible. The maximum pre-tensioning force F should not exceed 50% (~20° pre-tensioning).

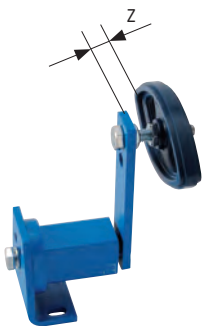

Use of SE-B Boomerang® tensioners

In very long chain and belt drives it was recommendable to install on the slack-side several tensioners, in order to compensate occurring elongation. The «Boomerang» with its bent double-arm equipped with two chain sprockets or a combination of grooved pulley and flat-roller (belt-drives) offers a triple-compensation of chain and belt elongations, due to S-shape contact-arc.

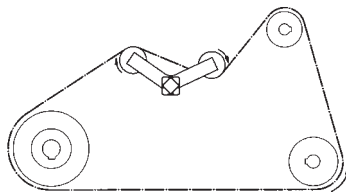

Assembly

The central screw is tightened slightly. The tensioner housing is set with a wrench and tightened in the desired direction. Then tighten the screw with the appropriate M_A tightening torque. Position the wrench near the flange bottom.

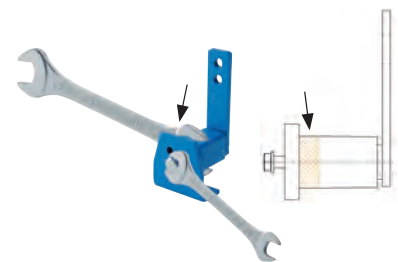

Chain or belt drives

Further assembly instructions specific for chain or belt drives on the following pages.

Installation guidelines for chain drives

Standard positioning

The ROSTA tensioning device should be placed on the slack-side of the chain drive, close by the smaller sprocket wheel in order to enlarge its contact-arc, therefore contact application from outer side of drive. In mounted position the tensioner-arm should stay close to parallel to the chain run, in drain direction. By extremely long chain drives it is recommendable to install several tensioners or the type «Boomerang®» in order to enlarge the slack compensation.

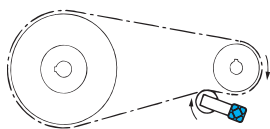

Reversible chain drive

On reversing chain drives, we recommend installing two chain tensioners, one per chain strand. Due to the constantly alternating slackening, depending on the direction of travel of the drive, both tensioners should only be pre-tensioned to a maximum of 20° to retain a free return angle of 10° when changing from the «slack section» to the «working section».

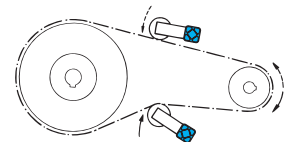

Sprocket teeth engaged

When tightening for the first time, at least 3 teeth of the sprocket must be engaged with the chain. The free length of the chain between tensioning wheel and the next sprocket should be at least 4 sections.

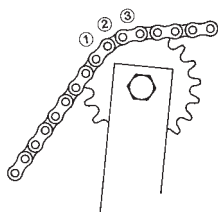

Chain track

The tensioner sprocket and the chain sliders should be positioned on the track between 2 nuts «C». The chain track can be precisely set by adjusting the setting range R . The lock nut «B» is always tight.

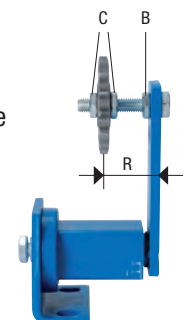

Installation guidelines for belt drives

1. Layout in belt drives

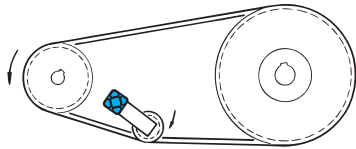

Tensioning from inside the belt drive with a V-belt pulley

- When installing in the slack section, both belt pulleys must have sufficient wrap angles (driver and driven).
- For vibration-intensive drives with very long centre distances, it is recommended use deep-grooved pulleys.

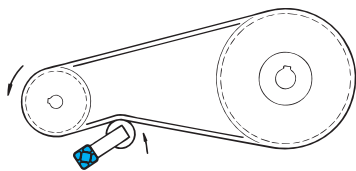

Tensioning with flat roller on the back of the belt

- Roll diameter should be at least 2/3 of the diameter of the smallest pulley.
- Roll width approx. 20% bigger than the overall width of the belt unit.
- When installing in the slack section, both belt pulleys must have sufficient wrap angles (driver and driven).

V-belt type	Diameter d of the smaller pulley [mm]	Initial operation test-force F_i^* [N]	1 belt	2 belts	3 belts	4 belts	5 belts	6 belts	7 belts	8 belts
SPZ/XPZ 3V/3VX	< 71	20	11	18	18	18	27	27	27	27
	71–90	22	11	18	18	18	27	27	27	27
	91–125	25	15	18	18	27	27	27	27	38
	> 125	28	15	18	18	27	27	27	38	38
SPA/XPA	< 101	28	15	18	18	27	27	27	38	38
	101–140	38	18	18	27	27	27	38	38	38
	141–200	45	18	18	27	27	38	38	38	38
	> 200	50	18	27	27	38	38	38	38	45
SPB/XPB 5V/5VX	< 161	50	27	27	27	38	38	38	38	45
	161–250	70	27	27	38	38	38	45	45	45
	251–355	80	27	27	38	38	45	45	45	45
SPC/XPC	> 355	90	27	27	38	38	45	45	45	50
	< 251	87	18	27	38	38	45	45	45	50
	251–355	115	27	38	38	45	45	50	50	50
8V	356–560	128	27	38	45	45	45	50	50	50
	> 560	145	27	38	45	45	50	50	50	**
	< 356	155	27	38	45	45	50	50	**	**
Z/ZX	356–450	190	27	45	45	50	50	**	**	**
	451–560	220	38	45	45	50	**	**	**	**
	> 560	230	38	45	50	50	**	**	**	**
A/AX	< 51	11	11	11	18	18	18	18	18	18
	51–70	12	11	11	18	18	18	18	18	27
	71–100	14	11	15	18	18	18	18	27	27
B/BX	> 100	17	11	18	18	18	18	18	27	27
	< 113	20	11	18	18	18	27	27	27	27
	113–200	22	11	18	18	18	27	27	27	27
C/CX	201–300	25	15	18	18	18	27	27	27	38
	> 300	28	15	18	18	27	27	27	38	38
	< 161	28	15	18	18	27	27	27	38	38
D	161–250	30	15	18	18	27	27	27	38	38
	251–355	33	18	18	27	27	27	38	38	38
	> 355	40	18	18	27	27	38	38	38	38
D	< 213	50	18	27	27	38	38	38	38	45
	213–280	55	18	27	27	38	38	38	45	45
	281–475	60	18	27	27	38	38	38	45	45
D	> 475	65	18	27	38	38	38	45	45	45
	< 356	80	18	27	38	38	45	45	45	45
	356–450	95	27	27	38	45	45	45	45	50
D	451–560	110	27	38	38	45	45	45	50	50
	> 560	120	27	38	38	45	45	50	50	50

2. Selection of the ROSTA tensioner device

Reference values for the most common types of V-belts

* Required test-force for belt deflection of 16 mm per 1 000 mm of center distance. The relevant deflection by shorter or longer center distance is proportional to 16 mm/m. The values may vary depending on the belt supplier.

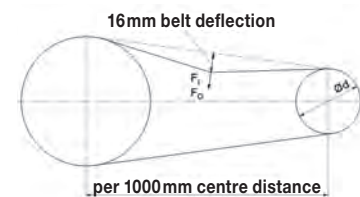

$$F = F_i \cdot z \cdot 2$$

F Resulting tensioning force by a SE pre-tension angle of 20° (see table «Tension force F»)

F_i Initial operation test-force

z Quantity of belts in drive

2 Multiplier e.g. to compensate for belt slip and/or of centrifugal force generated on the drive belts.

The operational test-force F_0 (after belt elongation) is around 20% lower than the initial test-force F_i . Therefore, we recommend to inspect the belt tension after a few days of operation.

** Please contact ROSTA

Tensioner devices

Installation guidelines for fast tension device SV

An additional drill hole (see drill hole specifications) is required for the swivel joint of the quick tensioning unit. The installation guidelines for the ROSTA tensioning element (e.g. position of the lever arm in relation to the chain or belt) must be observed. The quick pre-tensioning unit is to be attached to the tensioning element as deep as possible. Position the axis of rotation in the hole with the two nuts, but do not tighten it. Turn the pre-tensioning screw further until the ball is seated in the joint socket, which has been turned up to the stop in the pretensioning lever. The ball must be greased beforehand with a commercially available, graphitized or MoS₂-containing multipurpose grease. After the tensioning element has been pre-tensioned, the fastening screw of the tensioning element must be tightened.

The type SV quick tensioning unit can also be attached mirror-inverted or rotated by 90°.

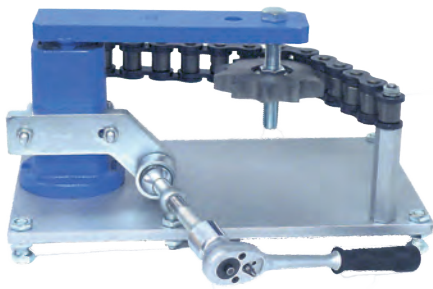

Untensioned



approx. 20° pre-tensioned

Drill hole specification for the Fast tension device SV

Type	B	r	α
SV 15/18	Ø 8.5 mm	93 mm	50°
SV 27	Ø 10.5 mm	110 mm	50°
SV 38	Ø 10.5 mm	150 mm	40°
SV 45	Ø 17.0 mm	190 mm	45°
SV 50	Ø 17.0 mm	190 mm	45°

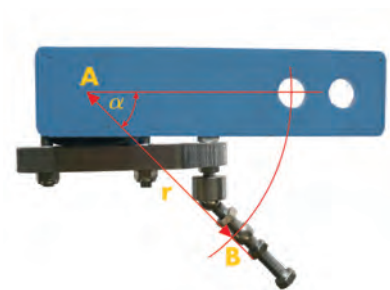

A = mounting hole or thread for the SE tensioner

B = hole for the eyebolt

Important

The ball socket should be screwed in as far as it will go in the pre-tensioning lever.

MOTORBASES



Motorbases

Usual positioning of the ROSTA motorbases

These recommendations are based on practical experience, a test run will show the ideal adjustment.

Vibrating screen applications

«Overhead» configuration

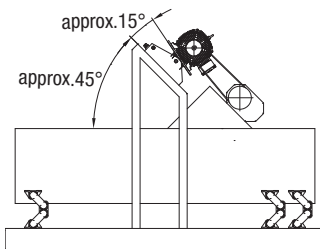

«Alongside» configuration

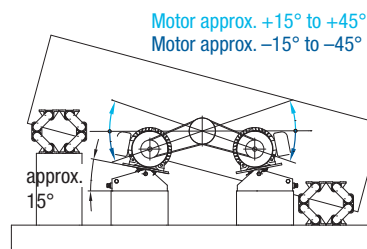

«Underneath» drive, feeder

Increased offset and larger Motorbase recommended.

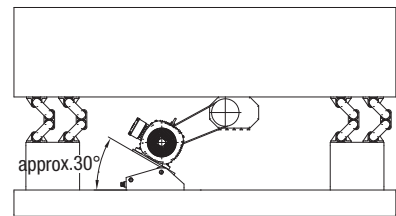

Pump applications

«Overhead» configuration

Motor plate «off-set», towards the pretensioning device.

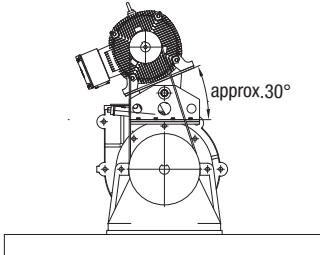

«Alongside» configuration

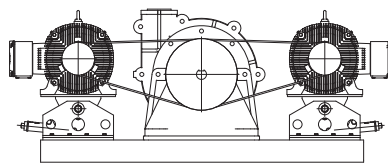

Crusher applications

Variable loads

Motor plate offset, in the direction of the pre-tensioning unit.

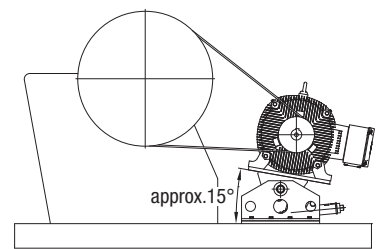

Range of application MB 27 and MB 38

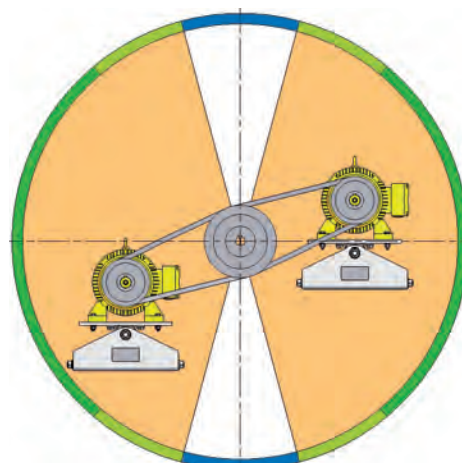
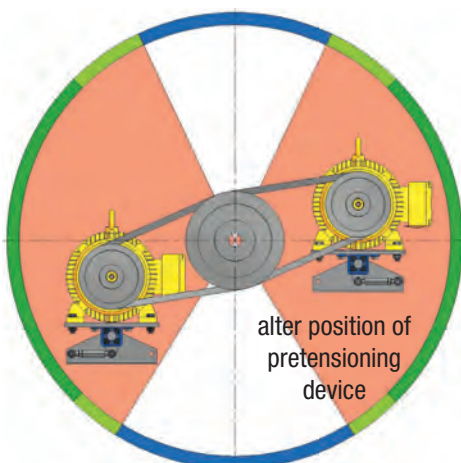

Longest tensioning path, ideal positioning range of the MB

Possible positioning range of the MB

Contact ROSTA

Motorbases

Range of application MB 50

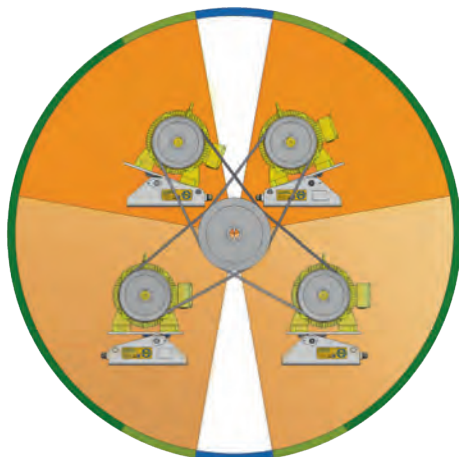

Top drive area:
Motor plate is tilted 30°

Drive area below:
Motor plate is horizontal

Longest tensioning path, ideal positioning range of the MB

Possible positioning range of the MB

Contact ROSTA

Range of application MB 75

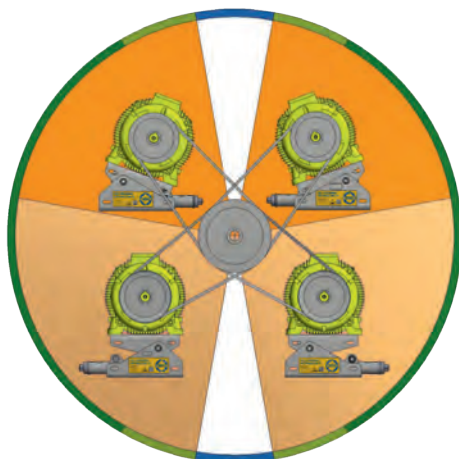

Top drive area:
Motor plate is tilted 30°

Drive area below:
Motor plate is horizontal

Longest tensioning path, ideal positioning range of the MB

Possible positioning range of the MB

Contact ROSTA

Range of application MB 100

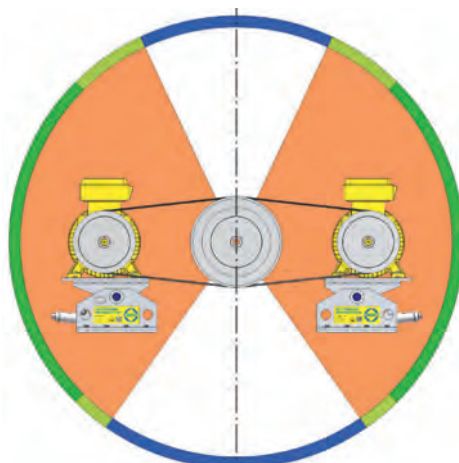

Longest tensioning path, ideal positioning range of the MB

Possible positioning range of the MB

Contact ROSTA

Test forces for belt tensioning

The ROSTA motorbase MB can be precisely pre-tensioned by means of the mechanical pretensioner in accordance with the test force prescribed by the belt manufacturer. The standard values of the test forces for the most common V-belt profiles are listed in the table. This simplified way to determine the pre-tension is sufficient in most applications.

Exception

In the case of vibrating screens, only tighten the belts so far as to guarantee they won't slip at the start and when they are running.

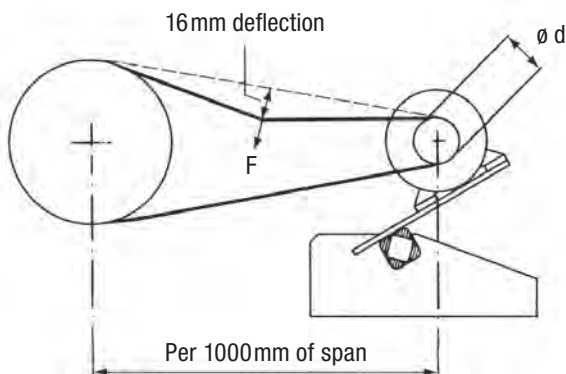

* Required test-force for belt deflection of 16 mm per 1 000 mm of center distance. The relevant deflection by shorter or longer center distance is proportional to 16 mm/m. The values may vary depending on the belt supplier.

The operational test-force (after belt elongation) is around 20% lower than the initial test-force F_I . Therefore, we recommend to inspect the belt tension after a few days of operation.

Standard values for the most common types of V-belts

V-belt type	Diameter d of the smaller pulley [mm]	Initial operation test-force F_I^* [N]
SPZ / XPZ 3V / 3VX	< 71	20
	71 – 90	22
	91 – 125	25
SPA / XPA	> 125	28
	< 101	28
	101 – 140	38
SPB / XPB 5V / 5VX	141 – 200	45
	> 200	50
	< 161	50
SPC / XPC	161 – 250	70
	251 – 355	80
	> 355	90
8V	< 251	87
	251 – 355	115
	356 – 560	128
Z / ZX	> 560	145
	< 356	155
	356 – 450	190
A / AX	451 – 560	220
	> 560	230
	< 51	11
B / BX	51 – 70	12
	71 – 100	14
	> 100	17
C / CX	< 113	20
	113 – 200	22
	201 – 300	25
D	> 300	28
	< 161	28
	161 – 250	30
D	251 – 355	33
	> 355	40
	< 213	50
D	213 – 280	55
	281 – 475	60
	> 475	65
D	< 356	80
	356 – 450	95
	451 – 560	110
D	> 560	120

PART NO. INDEX



Part no.	Type	Page
01 011 001	DR-A 15 × 25	2.4
01 011 002	DR-A 15 × 40	2.4
01 011 003	DR-A 15 × 60	2.4
01 011 004	DR-A 18 × 30	2.4
01 011 005	DR-A 18 × 50	2.4
01 011 006	DR-A 18 × 80	2.4
01 011 007	DR-A 27 × 40	2.4
01 011 008	DR-A 27 × 60	2.4
01 011 009	DR-A 27 × 100	2.4
01 011 010	DR-A 38 × 60	2.4
01 011 011	DR-A 38 × 80	2.4
01 011 012	DR-A 38 × 120	2.4
01 011 023	DR-A 45 × 80	2.4
01 011 024	DR-A 45 × 100	2.4
01 011 025	DR-A 45 × 150	2.4
01 011 026	DR-A 50 × 120	2.4
01 011 027	DR-A 50 × 200	2.4
01 011 028	DR-A 50 × 300	2.4
01 021 001	DR-S 11 × 20	2.6
01 021 002	DR-S 11 × 30	2.6
01 021 003	DR-S 11 × 50	2.6
01 021 004	DR-S 15 × 25	2.6
01 021 005	DR-S 15 × 40	2.6
01 021 006	DR-S 15 × 60	2.6
01 021 007	DR-S 18 × 30	2.6
01 021 008	DR-S 18 × 50	2.6
01 021 009	DR-S 18 × 80	2.6
01 021 010	DR-S 27 × 40	2.6
01 021 011	DR-S 27 × 60	2.6
01 021 012	DR-S 27 × 100	2.6
01 021 013	DR-S 38 × 60	2.6
01 021 014	DR-S 38 × 80	2.6
01 021 015	DR-S 38 × 120	2.6
01 021 026	DR-S 45 × 80	2.6
01 021 027	DR-S 45 × 100	2.6
01 021 028	DR-S 45 × 150	2.6
01 021 029	DR-S 50 × 120	2.6
01 021 030	DR-S 50 × 200	2.6
01 021 031	DR-S 50 × 300	2.6
01 031 001	DR-C 18 × 30	2.5
01 031 002	DR-C 18 × 50	2.5
01 031 003	DR-C 18 × 80	2.5
01 031 004	DR-C 27 × 40	2.5
01 031 005	DR-C 27 × 60	2.5
01 031 006	DR-C 27 × 100	2.5
01 031 007	DR-C 38 × 60	2.5
01 031 008	DR-C 38 × 80	2.5
01 031 009	DR-C 38 × 120	2.5
01 031 010	DR-C 15 × 25	2.5
01 031 011	DR-C 15 × 40	2.5
01 031 012	DR-C 15 × 60	2.5
01 031 023	DR-C 45 × 80	2.5
01 031 024	DR-C 45 × 100	2.5
01 031 025	DR-C 50 × 120	2.5
01 031 026	DR-C 50 × 200	2.5
01 041 001	DO-A 15 × 25	2.15
01 041 002	DO-A 15 × 40	2.15
01 041 003	DO-A 15 × 60	2.15
01 041 004	DO-A 18 × 30	2.15
01 041 005	DO-A 18 × 50	2.15
01 041 006	DO-A 18 × 80	2.15
01 041 007	DO-A 27 × 40	2.15
01 041 008	DO-A 27 × 60	2.15
01 041 009	DO-A 27 × 100	2.15

Part no.	Type	Page
01 041 010	DO-A 38 × 60	2.15
01 041 011	DO-A 38 × 80	2.15
01 041 012	DO-A 38 × 120	2.15
01 041 013	DO-A 45 × 80	2.15/3.18
01 041 014	DO-A 45 × 100	2.15/3.18
01 041 015	DO-A 45 × 150	2.15
01 041 026	DO-A 50 × 120	2.15/3.18
01 041 027	DO-A 50 × 200	2.15/3.18
01 041 029	DO-A 50 × 160	2.15/3.18
01 071 001	DK-A 15 × 25	2.8
01 071 002	DK-A 15 × 40	2.8
01 071 003	DK-A 15 × 60	2.8
01 071 004	DK-A 18 × 30	2.8
01 071 005	DK-A 18 × 50	2.8
01 071 006	DK-A 18 × 80	2.8
01 071 007	DK-A 27 × 40	2.8
01 071 008	DK-A 27 × 60	2.8
01 071 009	DK-A 27 × 100	2.8
01 071 010	DK-A 38 × 60	2.8
01 071 011	DK-A 38 × 80	2.8
01 071 012	DK-A 38 × 120	2.8
01 071 013	DK-A 45 × 80	2.8
01 071 014	DK-A 45 × 100	2.8
01 071 015	DK-A 45 × 150	2.8
01 071 016	DK-A 50 × 120	2.8
01 071 017	DK-A 50 × 200	2.8
01 071 018	DK-A 50 × 300	2.8
01 081 001	DK-S 11 × 20	2.9
01 081 002	DK-S 11 × 30	2.9
01 081 003	DK-S 11 × 50	2.9
01 081 004	DK-S 15 × 25	2.9
01 081 005	DK-S 15 × 40	2.9
01 081 006	DK-S 15 × 60	2.9
01 081 007	DK-S 18 × 30	2.9
01 081 008	DK-S 18 × 50	2.9
01 081 009	DK-S 18 × 80	2.9
01 081 010	DK-S 27 × 40	2.9
01 081 011	DK-S 27 × 60	2.9
01 081 012	DK-S 27 × 100	2.9
01 081 013	DK-S 38 × 60	2.9
01 081 014	DK-S 38 × 80	2.9
01 081 015	DK-S 38 × 120	2.9
01 081 016	DK-S 45 × 80	2.9
01 081 017	DK-S 45 × 100	2.9
01 081 018	DK-S 45 × 150	2.9
01 081 019	DK-S 50 × 120	2.9
01 081 020	DK-S 50 × 200	2.9
01 081 021	DK-S 50 × 300	2.9
01 101 016	DW-A 15 × 25	2.11
01 101 017	DW-A 15 × 40	2.11
01 101 018	DW-A 15 × 60	2.11
01 101 019	DW-A 18 × 30	2.11
01 101 020	DW-A 18 × 50	2.11
01 101 021	DW-A 18 × 80	2.11
01 101 022	DW-A 27 × 40	2.11
01 101 023	DW-A 27 × 60	2.11
01 101 024	DW-A 27 × 100	2.11
01 101 025	DW-A 38 × 60	2.11
01 101 026	DW-A 38 × 80	2.11
01 101 027	DW-A 38 × 120	2.11
01 101 031	DW-A 60 × 150	2.12
01 101 032	DW-A 60 × 200	2.12
01 101 033	DW-A 60 × 300	2.12
01 101 034	DW-A 70 × 200	2.12

Part no.	Type	Page
01 101 035	DW-A 70 × 300	2.12
01 101 036	DW-A 70 × 400	2.12
01 101 037	DW-A 80 × 200	2.12
01 101 038	DW-A 80 × 300	2.12
01 101 039	DW-A 80 × 400	2.12
01 101 040	DW-A 100 × 250	2.12
01 101 041	DW-A 100 × 400	2.12
01 101 042	DW-A 100 × 500	2.12
01 101 043	DW-A 45 × 80	2.11
01 101 044	DW-A 45 × 100	2.11
01 101 045	DW-A 45 × 150	2.11
01 101 046	DW-A 50 × 120	2.11
01 101 047	DW-A 50 × 160	2.11
01 101 048	DW-A 50 × 200	2.11
01 111 201	DW-S 15 × 25	2.14
01 111 202	DW-S 15 × 40	2.14
01 111 203	DW-S 15 × 60	2.14
01 111 204	DW-S 18 × 30	2.14
01 111 205	DW-S 18 × 50	2.14
01 111 206	DW-S 18 × 80	2.14
01 111 207	DW-S 27 × 40	2.14
01 111 208	DW-S 27 × 60	2.14
01 111 209	DW-S 27 × 100	2.14
01 111 210	DW-S 38 × 60	2.14
01 111 211	DW-S 38 × 80	2.14
01 111 212	DW-S 38 × 120	2.14
01 111 213	DW-S 45 × 80	2.14
01 111 214	DW-S 45 × 100	2.14
01 111 215	DW-S 45 × 150	2.14
01 111 216	DW-S 50 × 120	2.14
01 111 217	DW-S 50 × 160	2.14
01 111 218	DW-S 50 × 200	2.14
01 121 101	DW-C 15 × 25	2.13
01 121 102	DW-C 15 × 40	2.13
01 121 103	DW-C 15 × 60	2.13
01 121 104	DW-C 18 × 30	2.13
01 121 105	DW-C 18 × 50	2.13
01 121 106	DW-C 18 × 80	2.13
01 121 107	DW-C 27 × 40	2.13
01 121 108	DW-C 27 × 60	2.13
01 121 109	DW-C 27 × 100	2.13
01 121 110	DW-C 38 × 60	2.13
01 121 111	DW-C 38 × 80	2.13
01 121 112	DW-C 38 × 120	2.13
01 121 113	DW-C 45 × 80	2.13
01 121 114	DW-C 45 × 100	2.13
01 121 115	DW-C 45 × 150	2.13
01 121 116	DW-C 50 × 120	2.13
01 121 117	DW-C 50 × 160	2.13
01 121 118	DW-C 50 × 200	2.13
01 500 001	BR 11	2.7
01 500 002	BR 15	2.7
01 500 003	BR 18	2.7
01 500 004	BR 27	2.7
01 500 005	BR 38	2.7
01 500 026	BR 45	2.7
01 500 027	BR 50	2.7
01 520 001	BK 11	2.10
01 520 002	BK 15	2.10
01 520 003	BK 18	2.10
01 520 004	BK 27	2.10
01 520 005	BK 38	2.10
01 520 006	BK 45	2.10
01 520 007	BK 50	2.10

Part no.	Type	Page
02 000 301	MB 38 × 300	6.4
02 200 201	MB 27 × 120	6.3
02 200 526	MB 50 × 270-1	6.5
02 200 527	MB 50 × 270-2	6.5
02 200 528	MB 50 × 400	6.5
02 200 529	MB 50 × 500	6.5
02 200 900	MB 100 × 750	6.7
02 202 701	MB 75 × 450	6.6
02 202 702	MB 75 × 550	6.6
02 202 703	MB 75 × 700	6.6
05 011 001	V 15	4.5
05 011 002	V 18	4.5
05 011 003	V 27	4.5
05 011 005	V 45	4.5
05 011 006	V 50	4.5
05 011 024	V 38	4.5
05 021 001	ESL 15	4.3
05 021 002	ESL 18	4.3
05 021 003	ESL 27	4.3
05 021 004	ESL 38	4.3
05 021 005	ESL 45	4.3
05 021 016	ESL 50	4.3
05 021 017	ESL 50-1.6	4.3
05 021 018	ESL 50-2	4.3
05 058 021	N 80 M12	4.6
05 058 022	N 80 M16	4.6
05 058 024	N 120 M20	4.6
05 058 122	NOX 80 M16	4.6
05 058 124	NOX 120 M20	4.6
05 060 101	P 80	4.7
05 060 102	P 120	4.7
05 100 901	NE 50-12	4.9
05 100 902	NE 80-12	4.9
05 100 903	NE 400-12	4.9
05 111 101	AWI 15R	4.4
05 111 102	AWI 18R	4.4
05 111 103	AWI 27R	4.4
05 111 104	AWI 38R	4.4
05 111 105	AWI 45R	4.4
05 111 106	AWI 50R	4.4
05 111 108	AWI 50-2R	4.4
05 121 101	AWI 15L	4.4
05 121 102	AWI 18L	4.4
05 121 103	AWI 27L	4.4
05 121 104	AWI 38L	4.4
05 121 105	AWI 45L	4.4
05 121 106	AWI 50L	4.4
05 121 108	AWI 50-2L	4.4
05 158 001	M 43 M16	4.8
05 158 002	M 44 M16	4.8
05 158 003	M 45 M20	4.8
05 158 011	M 43W M16	4.8
05 158 012	M 44W M16	4.8
05 158 013	M 45W M20	4.8
06 011 001	SE 11	5.3
06 011 002	SE 15	5.3
06 011 003	SE 18	5.3
06 011 004	SE 27	5.3
06 011 005	SE 38	5.3
06 011 006	SE 45	5.3
06 011 007	SE 50	5.3
06 011 702	SE-R 15	5.3
06 011 703	SE-R 18	5.3
06 013 201	SE 11-G	5.3

Part no.	Type	Page
06 013 202	SE 15-G	5.3
06 013 203	SE 18-G	5.3
06 013 204	SE 27-G	5.3
06 013 205	SE 38-G	5.3
06 013 206	SE 45-G	5.3
06 013 207	SE 50-G	5.3
06 015 002	SE 15-W	5.3
06 015 003	SE 18-W	5.3
06 015 004	SE 27-W	5.3
06 015 005	SE 38-W	5.3
06 015 006	SE 45-W	5.3
06 015 007	SE 50-W	5.3
06 021 003	SE-B 18	5.5
06 021 004	SE-B 27	5.5
06 061 002	SE-F 15	5.6
06 061 003	SE-F 18	5.6
06 061 004	SE-F 27	5.6
06 061 005	SE-F 38	5.6
06 061 006	SE-F 45	5.6
06 061 007	SE-F 50	5.6
06 071 111	SE-I 15	5.4
06 071 112	SE-I 18	5.4
06 071 113	SE-I 27	5.4
06 071 114	SE-I 38	5.4
06 093 904	SE-FE 27	5.7
06 095 905	SE-FE 38	5.7
06 500 001	N^{3/8"}-10	5.9
06 500 002	N^{1/2"}-10	5.9
06 500 003	N^{1/2"}-12	5.9
06 500 004	N^{5/8"}-12	5.9
06 500 005	N^{5/8"}-20	5.9
06 500 006	N^{3/4"}-12	5.9
06 500 007	N^{3/4"}-20	5.9
06 500 008	N1"-20	5.9
06 500 009	N1^{1/4"}-20	5.9
06 500 010	N1^{1/2"}-20	5.9
06 510 001	N^{3/8"}-10 S	5.8
06 510 002	N^{1/2"}-10 S	5.8
06 510 003	N^{5/8"}-12 S	5.8
06 510 004	N^{3/4"}-12 S	5.8
06 510 005	N^{3/4"}-20 S	5.8
06 510 006	N1"-20 S	5.8
06 510 007	N1^{1/4"}-20 S	5.8
06 510 008	N1^{1/2"}-20 S	5.8
06 520 001	N^{3/8"}-10 D	5.8
06 520 002	N^{1/2"}-10 D	5.8
06 520 003	N^{5/8"}-12 D	5.8
06 520 004	N^{3/4"}-12 D	5.8
06 520 005	N^{3/4"}-20 D	5.8
06 520 006	N1"-20 D	5.8
06 520 007	N1^{1/4"}-20 D	5.8
06 520 008	N1^{1/2"}-20 D	5.8
06 530 001	N^{3/8"}-10 T	5.8
06 530 002	N^{1/2"}-12 T	5.8
06 530 003	N^{5/8"}-12 T	5.8
06 530 004	N^{5/8"}-20 T	5.8
06 530 005	N^{3/4"}-20 T	5.8
06 530 006	N1"-20 T	5.8
06 530 007	N1^{1/4"}-20 T	5.8
06 530 008	N1^{1/2"}-20 T	5.8
06 540 001	P^{3/8"}	5.11
06 540 002	P^{1/2"}	5.11
06 540 003	P^{5/8"}	5.11
06 540 004	P^{3/4"}	5.11

Part no.	Type	Page
06 550 001	P^{3/8"}-8 S	5.10
06 550 002	P^{1/2"}-10 S	5.10
06 550 003	P^{5/8"}-10 S	5.10
06 550 004	P^{3/4"}-12 S	5.10
06 560 001	P^{3/8"}-8 D	5.10
06 560 002	P^{1/2"}-10 D	5.10
06 560 003	P^{5/8"}-10 D	5.10
06 560 004	P^{3/4"}-12 D	5.10
06 580 001	R 11	5.12
06 580 002	R 15/18	5.12
06 580 003	R 27	5.12
06 580 004	R 38	5.12
06 580 005	R 45	5.12
06 580 901	RL 11	5.13
06 580 902	RL 15/18	5.13
06 580 903	RL 27	5.13
06 590 001	WS 11-15/WS 11	2.16/5.14
06 590 002	WS 15-18/WS 15	2.16/5.14
06 590 003	WS 18-27/WS 18	2.16/5.14
06 590 004	WS 27-38/WS 27	2.16/5.14
06 590 005	WS 38-45/WS 38	2.16/5.14
06 590 006	WS 45-50/WS 45	2.16/5.14
06 600 203	VS 15/18	5.16
06 600 204	VS 27	5.16
06 600 205	VS 38	5.16
06 600 206	VS 45	5.16
06 600 207	VS 50	5.16
06 600 301	SV 27	5.17
06 600 302	SV 38	5.17
06 600 303	SV 45	5.17
06 600 304	SV 50	5.17
06 600 305	SV 15/18	5.17
06 618 394	SS 38	5.15
06 618 400	SS 27	5.15
07 011 001	AU 15	3.10
07 011 002	AU 18	3.10
07 011 003	AU 27	3.10
07 011 004	AU 38	3.10
07 011 005	AU 45	3.10
07 011 006	AU 50	3.10
07 011 007	AU 60	3.10
07 021 001	AU 15L	3.10
07 021 002	AU 18L	3.10
07 021 003	AU 27L	3.10
07 021 004	AU 38L	3.10
07 021 005	AU 45L	3.10
07 021 006	AU 50L	3.10
07 021 007	AU 60L	3.10
07 031 001	ST 18	3.16
07 031 002	ST 27	3.16
07 031 003	ST 38	3.16
07 031 004	ST 45	3.16
07 031 005	ST 50	3.16
07 031 015	ST 50-2	3.16
07 031 016	ST 60-3	3.16
07 031 026	ST 60	3.16
07 031 027	ST 80	3.16
07 041 001	ST 18L	3.16
07 041 002	ST 27L	3.16
07 041 003	ST 38L	3.16
07 041 004	ST 45L	3.16
07 041 005	ST 50L	3.16
07 041 015	ST 50-2L	3.16
07 041 016	ST 60-3L	3.16

Part no.	Type	Page
07 041 026	ST 60L	3.16
07 041 027	ST 80L	3.16
07 051 042	AB 45	3.4
07 051 043	AB 50	3.4
07 051 044	AB 50-2	3.4
07 051 046	AB 50 TWIN	3.5
07 051 047	AB 50-2 TWIN	3.5
07 051 056	AB 15	3.4
07 051 057	AB 18	3.4
07 051 058	AB 27	3.4
07 051 059	AB 38	3.4
07 051 070	AB-HD 27	3.6
07 051 071	AB-HD 38	3.6
07 051 076	AB-HD 70-3	3.7
07 051 080	AB-HD 100-2.5	3.7
07 051 081	AB-HD 100-4	3.7
07 051 082	AB-HD 45	3.6
07 051 083	AB-HD 50	3.6
07 051 084	AB-HD 50-1.6	3.6
07 051 085	AB-HD 50-2	3.6
07 061 001	AK 15	3.19
07 061 002	AK 18	3.19
07 061 003	AK 27	3.19
07 061 004	AK 38	3.19
07 061 005	AK 45	3.19
07 061 009	AK 100-4	3.19
07 061 010	AK 100-5	3.19
07 061 011	AK 50	3.19
07 061 012	AK 60	3.19
07 061 013	AK 80	3.19
07 071 001	AS-C 15	3.12
07 071 004	AS-C 38	3.12
07 071 005	AS-C 45	3.12
07 071 006	AS-C 50	3.12
07 071 012	AS-C 18	3.12
07 071 013	AS-C 27	3.12
07 081 001	AS-P 15	3.11
07 081 004	AS-P 38	3.11
07 081 005	AS-P 45	3.11
07 081 006	AS-P 50	3.11
07 081 012	AS-P 18	3.11
07 081 013	AS-P 27	3.11
07 091 001	AS-PV 15	3.11
07 091 004	AS-PV 38	3.11
07 091 005	AS-PV 45	3.11
07 091 006	AS-PV 50	3.11
07 091 012	AS-PV 18	3.11
07 091 013	AS-PV 27	3.11
07 101 001	AD-C 18	3.14
07 101 002	AD-C 27	3.14
07 101 003	AD-C 38	3.14
07 101 004	AD-C 45	3.14
07 111 001	AD-P 18	3.13
07 111 002	AD-P 27	3.13
07 111 003	AD-P 38	3.13
07 111 004	AD-P 45	3.13
07 111 005	AD-P 50	3.13
07 121 001	AD-PV 18	3.13
07 121 002	AD-PV 27	3.13
07 121 003	AD-PV 38	3.13
07 121 004	AD-PV 45	3.13
07 121 005	AD-PV 50	3.13
07 131 111	AUI 15	3.10
07 131 112	AUI 18	3.10

Part no.	Type	Page
07 131 113	AUI 27	3.10
07 141 111	AUI 15L	3.10
07 141 112	AUI 18L	3.10
07 141 113	AUI 27L	3.10
07 151 111	STI 18	3.17
07 151 112	STI 27	3.17
07 161 111	STI 18L	3.17
07 161 112	STI 27L	3.17
07 171 107	ABI 15	3.4
07 171 109	ABI 27	3.4
07 171 110	ABI 38	3.4
07 171 111	ABI 45	3.4
07 171 112	ABI 50	3.4
07 171 113	ABI 50-2	3.4
07 171 114	ABI 18	3.4
07 171 121	ABI-HD 15	3.6
07 171 123	ABI-HD 27	3.6
07 171 124	ABI-HD 38	3.6
07 171 125	ABI-HD 45	3.6
07 171 126	ABI-HD 50	3.6
07 171 127	ABI-HD 50-2	3.6
07 171 128	ABI-HD 18	3.6
07 261 001	AV 18	3.20
07 261 002	AV 27	3.20
07 261 003	AV 38	3.20
07 261 005	AV 50	3.20
07 261 014	AV 40	3.20
07 271 001	AV 18L	3.20
07 271 002	AV 27L	3.20
07 271 003	AV 38L	3.20
07 271 005	AV 50L	3.20
07 271 014	AV 40L	3.20
07 281 000	AB-D 18	3.9
07 281 001	AB-D 27	3.9
07 281 002	AB-D 38	3.9
07 281 003	AB-D 45	3.9
07 281 004	AB-D 50	3.9
07 281 005	AB-D 50-1.6	3.9
07 281 006	AB-D 50-2	3.9
07 291 003	AR 27	3.15
07 291 004	AR 38	3.15
07 291 005	AR 45	3.15
07 311 001	HS 27	3.8
07 311 002	HS 38	3.8
07 311 013	HS 45	3.8
07 311 014	HS 50	3.8
07 311 015	HS 50-2	3.8
07 321 101	HSI 15	3.8
07 321 102	HSI 18	3.8
07 321 103	HSI 27	3.8
07 321 104	HSI 38	3.8
07 321 105	HSI 45	3.8
07 321 106	HSI 50	3.8
07 321 107	HSI 50-2	3.8

PRODUCTIVITY THROUGH COMPETENCE



APPLIED
Industrial Technologies

Changes regarding data reserved.
Any reprint, also in extracts, requires
our explicit and confirmed approval.

Our Locations

ABN 63 006 100 045



NEW SOUTH WALES

ALBURY

443 Townsend Street
Albury, NSW 2640
P: (02) 6041 1744 | F: (02) 6041 3117
au-albury@appliedau.com

BATHURST

Unit 2/5 Watt Drive
Bathurst, NSW 27 95
P: (02) 6332 2443 | F: (02) 6332 2941
au-bathurst@appliedau.com

DUBBO

Unit 5, 46-50 Bourke Street
Dubbo, NSW 2830
P: (02) 6882 5799 | F: (02) 6884 1764
au-dubbo@appliedau.com

MINTO

Unit 3, 109 Airds Road
Minto, NSW 2566
P: (02) 9820 1088 | F: (02) 9820 2999
au-minto@appliedau.com

PENRITH

Unit 7, 115 Batt Street
Penrith, NSW 2750
P: (02) 4731 3268 | F: (02) 4731 3142
au-penrith@appliedau.com

SANDGATE

Unit 1, 4 Friesian Close
Sandgate, NSW 2304
P: (02) 4960 9222 | F: (02) 4960 9299
au-newcastle@appliedau.com

WETHERILL PARK

Unit 1, 1 Widemere Road
Wetherill Park, NSW 2164
P: (02) 9725 9200 | F: (02) 9725 9212
au-wetherillpark@appliedau.com

QUEENSLAND

ARCHERFIELD

282 Beatty Road
Archerfield, QLD 4108
P: (07) 3853 1900 | F: (07) 3853 1977
au-archerfield@appliedau.com

CAIRNS

117 Lyons Street
Cairns, QLD 4870
P: (07) 4040 9000 | F: (07) 4040 9010
au-cairns@appliedau.com

GEEBUNG

Unit 1, 473-475 Newman Road
Geebung, QLD 4034
P: (07) 3265 6966 | F: (07) 3865 1406
au-geebung@appliedau.com

GLADSTONE

68 Hanson Road
Gladstone, QLD 4680
P: (07) 4972 6255 | F: (07) 4972 2343
au-gladstone@appliedau.com

MACKAY

9 Progress Drive, Paget
Mackay, QLD 4740
P: (07) 4952 4833 | F: (07) 4957 4861
au-mackay@appliedau.com

MT ISA

26 Marian Street
Mt Isa, QLD 4825
P: (07) 4743 1908 | F: (07) 4743 1918
au-mtisa@appliedau.com

TOOWOOMBA

343 Taylor Street
Toowoomba, QLD 4350
P: (07) 4634 9140 | F: (07) 4634 9408
au-toowoomba@appliedau.com

TOWNSVILLE

70 Pilkington Street
Townsville, QLD 4810
P: (07) 4779 3699 | F: (07) 4725 1428
au-townsville@appliedau.com

SOUTH AUSTRALIA

WINGFIELD

Unit 1 & 2, 7-9 Streiff Road
Wingfield, SA 5013
P: (08) 8360 1500 | F: (08) 8260 3377
au-wingfield@appliedau.com

VICTORIA

BROOKLYN

755 Geelong Road
Brooklyn, VIC 3012
P: (03) 9318 0699 | F: (03) 9318 0733
au-brooklyn@appliedau.com

CAMPBELLFIELD

Unit 5, 2122 Hume Highway
Campbellfield, VIC 3061
P: (03) 9308 5144 | F: (03) 9308 5046
au-campbellfield@appliedau.com

DANDENONG

Unit 3A/13 Abbots Road
Dandenong South, VIC 3175
P: (03) 9794 8477 | F: (03) 9706 7385
au-dandenong@appliedau.com

HEAD OFFICE

22 Stamford Road
Oakleigh, VIC 3166
P: (03) 9567 8700 | F: (03) 9567 8733

NORTHERN TERRITORY

BERRIMAH

Applied Fluid Systems & Branch
101 Pruen Road
Berrimah, NT 0828
P: (08) 8947 1855 | F: (08) 8947 0403
au-berrimah@appliedau.com

WESTERN AUSTRALIA

ALBANY

Great Southern Bearings
38 Newbey Street
Albany, WA 6330
P: (08) 9842 1000 | F: (08) 9842 1122
au-albany@appliedau.com

NORTHAM

Northam Bearing Sales
100 Old York Road
Northam, WA 6401
P: (08) 9622 2922 | F: (08) 9622 5331
au-northam@appliedau.com

WELSHPOOL

272 Welshpool Road
Welshpool, WA 6106
P: (08) 9470 7600 | F: (08) 9356 7574
au-welshpool@appliedau.com

WEST KALGOORLIE

19 Darcy Lane
West Kalgoorlie, WA 6430
P: (08) 9091 4277 | F: (08) 9091 4267
au-kalgoorlie@appliedau.com



**SCAN THE QR CODE
& CONNECT WITH US**

*CONTACT AN APPLIED®
REPRESENTATIVE TODAY!*

 **BECOME A FAN**

 **FOLLOW US**

 **SHOP ONLINE**

 **JOIN OUR NETWORK**

Our New Zealand Locations

CN 1819

BRANCHES

AUCKLAND

Head Office & Branch
67 Lady Ruby Drive, East Tamaki,
Auckland 2013
P: (09) 274 0056
nz-auckland@appliednz.com

CHRISTCHURCH

Unit 8, 303 Blenheim Road
Upper Riccarton, Christchurch
8041 Auckland 2013
P: (03) 341 6537
nz-christchurch@appliednz.com

LOWER HUTT

22 Waione Street, Lower Hutt,
Wellington 5012
P: (04) 569 3159
nz-wellington@appliednz.com

NEW PLYMOUTH

Unit 1, 37 Hurlstone Drive
Waiwhakaiho, New Plymouth 4312
P: (06) 769 5152
nz-newplymouth@appliednz.com

DUNEDIN

4-6 McBride Street, Dunedin 9012
P: (03) 455 5652
nz-dunedin@appliednz.com

PALMERSTON NORTH

601D Tremaine Avenue
Palmerston North 4410
P: (06) 356 9145
nz-palmerstonnorth@appliednz.com

HASTINGS

1206 Omahu Road, Hastings 4175
P: (06) 879 4362
nz-hastings@appliednz.com

ROTORUA

45 White Street, Fenton Park,
Rotorua 3010
P: (07) 349 2451
nz-rotorua@appliednz.com



**SCAN THE QR CODE
& CONNECT WITH US**

*CONTACT AN APPLIED®
REPRESENTATIVE TODAY!*



BECOME A FAN



FOLLOW US



SHOP ONLINE



JOIN OUR NETWORK